

# PS-6002 & PS-6003

## PLATINUM SERIES INSTALLATION/OPERATION GUIDE

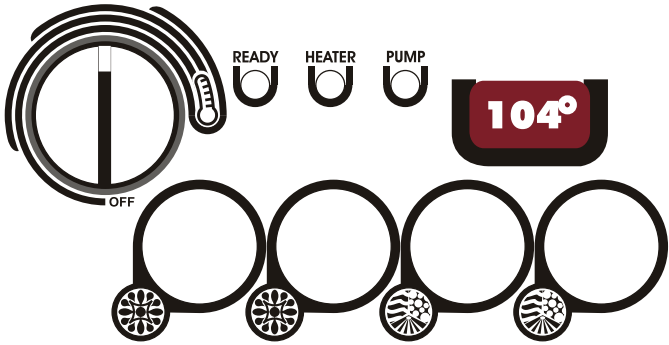



# CONTENTS

<b>Important Safety Instructions</b> ·····	<b>2-3</b>
<b>INSTALLATION</b> ·····	<b>4-16</b>
<b>Remote heaters</b> ·····	<b>6</b>
<b>Electrical</b> ·····	<b>6-7</b>
<b>System Configuration</b> ·····	<b>7</b>
<b>Heater Conversion</b> ·····	<b>8</b>
<b>Temp Sensor Mounting</b> ·····	<b>8</b>
<b>Equipment Connections</b> ·····	<b>9</b>
<b>Wet Connections</b> ·····	<b>9</b>
<b>Spa Light</b> ·····	<b>9</b>
<b>GFCI</b> ·····	<b>10</b>
<b>Pressure Switch</b> ·····	<b>10</b>
<b>System Timer (Setting Filtration)</b> ·····	<b>11</b>
<b>Mode Selection</b> ·····	<b>11</b>
<b>Heater “ON” Indicator</b> ·····	<b>12</b>
<b>Topside Options</b> ·····	<b>12</b>
<b>Topside</b> ·····	<b>12-15</b>
<b>Thermostat Setting</b> ·····	<b>15</b>
<b>Heater Operation</b> ·····	<b>16</b>
<b>OPTIONAL CORD ADAPTOR KIT</b> ·····	<b>16</b>
<b>OPERATIONAL CONSIDERATIONS</b> ·····	<b>17</b>
<b>Warm Weather Conditions</b> ·····	<b>17</b>
<b>Filtration System</b> ·····	<b>17</b>
<b>Winterizing</b> ·····	<b>17</b>
<b>Chemical Water Treatment</b> ·····	<b>17</b>
<b>TROUBLESHOOTING</b> ·····	<b>18-19</b>
<b>SYSTEM DATA LABEL</b> ·····	<b>20</b>
<b>WARRANTY INFORMATION</b> ·····	<b>20</b>

# IMPORTANT SAFETY INSTRUCTIONS

## READ AND FOLLOW ALL INSTRUCTIONS

**DANGER** To reduce the risk of injury, do not permit children to use this product unless they are closely supervised at all times.

**WARNING - RISK OF CHILD DROWNING.** Extreme caution must be exercised to prevent unauthorized access by children. To avoid accidents, ensure that children cannot use a spa or hot tub unless they are supervised at all times.

**DANGER** To reduce the risk of injury to persons, do not remove suction fitting covers.

Spa location must accommodate sufficient drainage of water around the base of the structure, as well as the power source compartment.

Prolonged immersion in water that is warmer than normal body temperature can result in a dangerous condition known as **HYPERTHERMIA**. The causes, symptoms, and effects of hyperthermia may be described as follows: several degrees above the normal body temperature of 98.6°F. The symptoms of hyperthermia include dizziness, fainting, drowsiness, lethargy, and an increase in the internal temperature of the body. The effects of hyperthermia include (1) unawareness of impending hazard, (2) failure to perceive heat, (3) failure to recognize the need to exit spa, (4) physical inability to exit spa, (5) fetal damage in pregnant women, (6) unconsciousness resulting in danger of drowning. **WARNING** The use of alcohol, drugs or medication can greatly increase the risk of fatal hyperthermia in hot tubs and spas.

**DANGER - RISK OF ELECTRICAL SHOCK.** Install at least 5 feet (1.5m) from all metal surfaces. (A spa may be installed within 5 feet of metal surfaces if each metal surface is permanently connected by a solid copper conductor attached to the ground bar on the terminal box that is provided for this purpose. Refer to NEC and local codes in effect at the time of installation.)

A ground or bonding bar is provided on the control box to permit connection of a solid copper bonding conductor between this point and any equipment, metal enclosures of electrical equipment, metal water pipe, or conduit within 5 feet (1.5m) of the unit as needed to comply with local requirements.

Bond accessible metal to the dedicated connector on the equipment grounding bus, bond the equipment ground bus to the local common bonding grid as part of the installation in the form of (1) a reinforced concrete slab for support, (2) a ground plate provided beneath the hot tub or spa, or (3) a permanent ground connection that is acceptable to the local inspection authority.

**DANGER RISK OF ELECTRICAL SHOCK.** Do not permit any electrical appliance such as a light, telephone, radio, or television, within 5 feet (1.5m) of a spa or hot tub.

### **To reduce the risk of injury:**

The water in a spa or hot tub should never exceed 104°F (40°C). Water temperatures between 100°F (38°C) and 104°F (40°C) are considered safe for a healthy adult. Lower water temperatures are recommended for extended use (exceeding 10-15 minutes) and for young children.

Excessive water temperatures have a high potential for causing fetal damage during the early months of pregnancy. Pregnant or possibly pregnant women should limit spa or hot tub water temperatures to 100°F (38°C).



Before entering the spa or hot tub, the user should measure the water temperature with an accurate thermometer.

The use of alcohol, drugs, or medication before or during spa or hot tub use may lead to unconsciousness with the possibility of drowning.

Persons suffering from obesity or with a medical history of heart disease, low or high blood pressure, circulatory system problems, or diabetes should consult a physician before using a spa or hot tub.

Persons using medication should consult a physician before using a spa or hot tub since some medication may affect heart rate, blood pressure, and circulation.

### **For Units with a GFCI (Ground Fault Circuit Interrupter)**

This appliance is provided with a ground-fault-circuit-interrupter located on the control box. Before each use and with the unit operating, push the test button. The unit should stop operating and the reset button should appear. Push the reset button. The unit should now operate normally. If the interrupter does not perform in this manner, a ground current is flowing indicating the possibility of electrical shock. Disconnect the power, or unplug from receptacle, until the fault has been identified and corrected.

### **For Cord and Plug Connected Units**

Connect to a grounded, grounding type receptacle only. NEVER connect the spa to an extension cord.

Do not bury the cord.

**WARNING** To reduce the risk of electrical shock, replace damaged cord immediately.

### **For Permanently Installed Units**

A terminal marked "G" or "ground" is provided in the wiring box located inside the equipment compartment. To reduce the risk of electric shock, connect the terminal or connector to the grounding terminal of your electrical service or supply panel with a continuous green insulated copper wire in accordance with National Electric Code Table 250-95 and any other local codes in effect at the time of installation.

### **For Permanently Installed Units not Provided with an Internal Disconnecting Method**

The electrical supply for this product must include a suitably rated switch or circuit breaker to open all ungrounded supply conductors to comply with Section 422-30 of the National Electric Code, ANSI/NFPA 70 1978. The disconnecting means must be readily accessible to the tub occupant but installed at least 5 feet (1.5m) from the tub water.

### **For Units with Gas Heaters**

**WARNING** - Do not install indoors. This unit uses a gas heater that requires proper ventilation and is intended for outdoor use only.

### **For UL Listed Equipment Assemblies**

Install at least 5 feet (1.5m) from tub water using nonmetallic plumbing. Install blower no less than 1 foot (305mm) above the maximum water level to prevent water from contacting electrical equipment. Install in accordance with blower installation instructions.

To reduce the risk of drowning from hair and body entrapment, install a suction fitting(s) & cover(s) with a marked flow rate in gallons-per-minute that equals or exceeds the flow rate marked on the equipment assembly.

# INSTALLATION

The Hydro-Quip "Slide" series control offers the ultimate in installation flexibility. The heater can be installed at the bottom, top, back, or remotely up to 60"\* away allowing for full coverage of all installation variations. \*Requires the purchase of optional heater assembly. If installing with optional "L-shaped" heater, follow back installation below. Hydro-Quip assumes the person installing this control system is a qualified Service Professional and is familiar with their local codes and regulations.

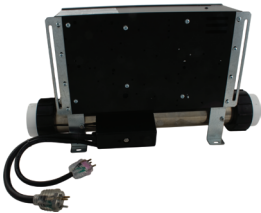

Remove control box and heater assembly from carton and verify contents for completeness.

**For a bottom installation** of heater loosen the 2ea. 3/8" nuts on the adjustable clamps then loosen the adjustable clamps just enough as to move freely. Slide the heater between the feet placing the studs from the adjustable clamps into the slots provided on the feet and tighten the 2ea 3/8" nuts, then tighten the adjustable clamp.

**For Back Installation** utilize the slide brackets, loosen the adjustable clamps just enough as to move freely. Remove 2ea 3/8" nuts. Align the 2 studs with the slots on the back of the control box. Reinstall 2ea 3/8" nuts, leave the nuts loose until you have adjusted the heater to the proper location then tighten the 2ea 3/8" nuts. Finish by tightening the adjustable clamps with the box rotated as explained on page 5.

**For Top Installation** remove the 8 screws from the left and right slide brackets, raise each bracket up one position, than replace all 8 screws. Loosen the adjustable clamps just enough as to move freely. Remove 2ea 3/8" nuts. Align the 2 studs with the slots on the back of the control box. Reinstall 2ea 3/8" nuts, leave the nuts loose until you have adjusted the heater to the proper location then tighten the 2ea 3/8" nuts. Finish by tightening the adjustable clamps with the box rotated as explained on page 5.

## Slide Configurations Cont.



Insert the sensor probe(s) under the sensor cover attached to the heater and tighten the wing-nut securely.

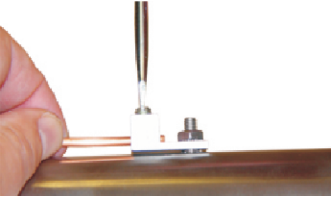

Ground/Bond the control box directly to the heater using the included #8 solid copper bonding wire.

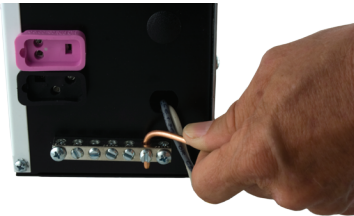

Ground/Bond the heater directly to the control box using the included #8 solid copper bonding wire.



Connect the power and control cords from the heater to the matching receptacles on the side of the control box.

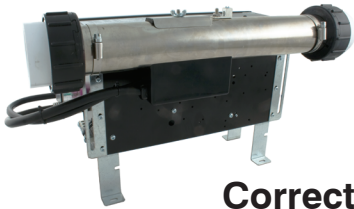

**Correct**

Installing in a horizontal position or pointing down are both proper installation orientations only.

Failure to follow this instruction may result in false tripping of the high limit circuit

For proper operation of the heater it must NOT be installed with the heater box pointing up.



**Correct**

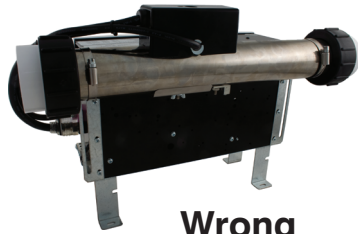

**Wrong**

## Optional Heaters

### Remote Heaters:

The Remote Heaters are supplied with a 60" cord which allows for versatile installations and locations with multiple angles. **BE SURE HEATER IS INSTALLED ON PRESSURE SIDE OF PUMP AND HEATER BOX INSTALLED HORIZONTAL OR PREFERABLY DOWN.** HEATER MUST BE BONDED TO THE CONTROL BOX USING A #8 SOLID COPPER BONDING WIRE (NOT INCLUDED).

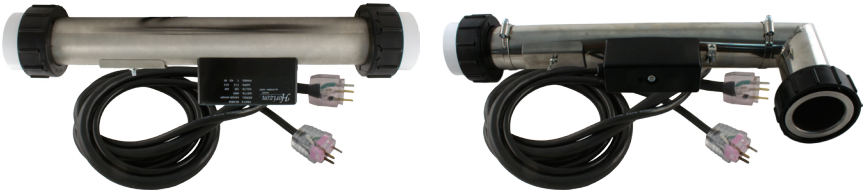

## Electrical

A qualified and licensed electrician in accordance with the National Electric Code (NEC) Article 680, Canadian Electric Code, and with any local codes must accomplish the electrical installation.

All connections must be made according to the electrical installation label on the outside of the control box. Follow the instructions from the label if they are different than the instructions in this manual. If your electrician is not absolutely sure how to connect your system correctly, call your local dealer. Any mistake may be costly and invalidate your equipment warranty.

The GFCI (Ground Fault Circuit Interrupter) is a mandatory electrical safety device required for all portable spas and hot tubs as specified in the National Electrical Code Article 680-42. The GFCI in your particular installation may be installed at the electrical service panel, a separate sub-panel or built into your system.

Your spa equipment requires a **DEDICATED CIRCUIT**. No other appliances or lights can be on this circuit. Refer to equipment data label for power supply requirements of your spa equipment.

Use copper conductors **ONLY**. The ground must be sized following the National Electric Code, Table 250-95.

### 120 Volt

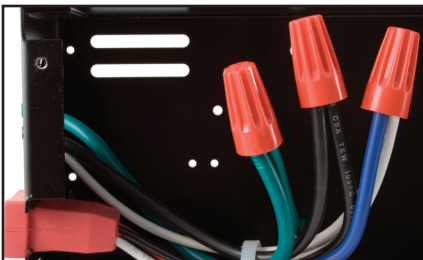

### 240 Volt



## Electrical Cont.

Universal Systems require a Neutral wire therefore the service required is as follows: 120-volt systems require a three-wire electrical service including ground, consisting of Line 1 (Black), Neutral (White) and Ground (Green) **(system Line 2 (Blue) connected together with the Neutral (White))**. 240-volt systems require a four wire electrical service including ground, consisting of Line 1 (Black), Line 2 (Red), Neutral (White) and Ground (Green).

## System Configuration

*Congratulations on your purchase of the Universal Series Control System. This series of controls has been developed to allow you complete flexibility during your installation. This Control System is configured to allow you to choose the voltage for each circuit at the time of installation. We highly recommend that all component cords be replaced at the time of installation.*

The Universal conversion procedure **MUST** be accomplished **PRIOR** to connecting input service wiring. This control has been shipped from the factory with **ALL** circuits wired for **120 VAC**.

**VERIFY YOUR COMPONENT VOLTAGE REQUIREMENTS:** 120 VAC will not harm a 240 VAC component if operated temporarily. 240 VAC **WILL** harm a 120 VAC component almost immediately. This is the reason we ship all circuits in the 120 VAC configuration. We cannot be held responsible for mis-wire related damage to components.

Note: To utilize the Universal circuitry (120/240VAC), incoming service must be 240V/4-Wire.

**We have made the conversion process simple and easy. After you have determined the voltage of your components (pump(s), air blower, ozonator etc.), you are now ready to complete the conversion process. Color-Coded Neutral Wire connectors have been provided to easily distinguish the circuit to be converted. By simply moving a Neutral wire from the Neutral side of the conversion terminal block, clearly marked and located inside the control enclosure, to the Line 2 side completes the circuit conversion. Follow the illustrations and step-by-step instructions.**

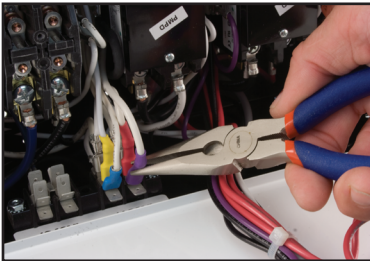

**Step 1:** Remove 2(ea) screws and open front cover of enclosure. Locate the conversion terminal block and desired connector. Use the Corresponding color wire for each receptacle to be converted. Carefully remove connector from the Neutral side.

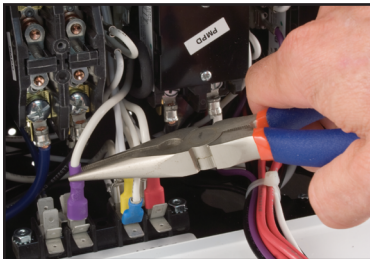

**Step 2:** Reinstall the connector onto the "Line 2" side. The conversion is complete and the circuit is now ready for a 240VAC component. Note: Repeat this procedure for each circuit.

## Heater Conversion

**Step 1:** Your system can be set for High Current (HC) or Low Current (LC) operation (the connection is pre-configured at the factory for low current). In the Low Current configuration the heater will automatically turn off when the high-speed of the pump or the air blower is activated. For unrestricted High Current operation, simply turn input power off, locate and disconnect the conversion plug and receptacle.

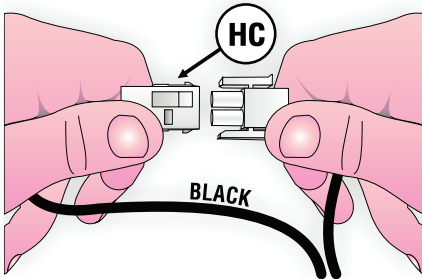
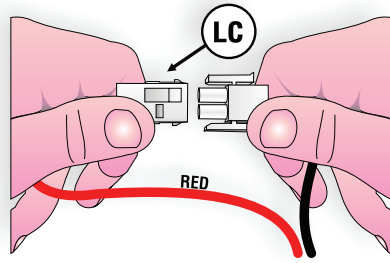

**Step 2:** Now reinstall the conversion plug into the High Current (HC) conversion receptacle. The conversion is complete. Reapply power and operate the spa normally. When the high-speed of the pump or the air blower are turned on, the heater will not shut off.

## Temp Sensor Mounting

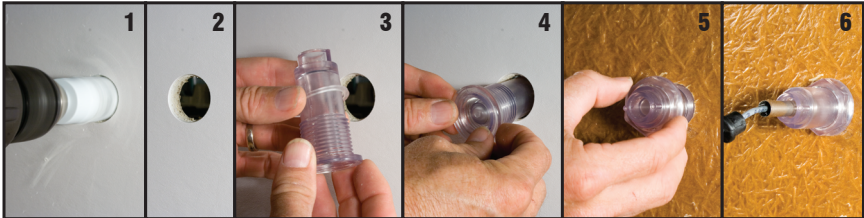

Refer to the photos above. When installing the supplied temperature sensor drywell in the wall of the tub, find a location as low as possible and close to a suction fitting. Try to stay away from fittings returning water back to the tub. Drill a 1-3/16" hole from inside the tub (1-2), install the supplied gasket onto the drywell and insert into the hole from inside the tub (3-4), install the fastening nut from outside the tub shell and tighten 1/4 turn past hand tight (5), and install the temperature sensor into the drywell (6).

A 5/16" drywell (sold separately) can be installed in the plumbing if necessary. Select an area that is located within the suction lines between the body of water and the filtration pump for the most accurate temperature readings.



## Equipment Connections

LH (Less Heater) Cord Connections:

### Air Activated Units - Remote Heater Connection Instructions

**WARNING** - Disconnect all power prior to completing the cord installation. While your wiring may differ, you must connect each component as shown below.

All existing jumpers and wires must be removed before attempting to connect circuits.

Failure to connect wires exactly as shown will cause an electrical malfunction that will result in damage to the control and/or heater. This damage will not be covered under warranty.

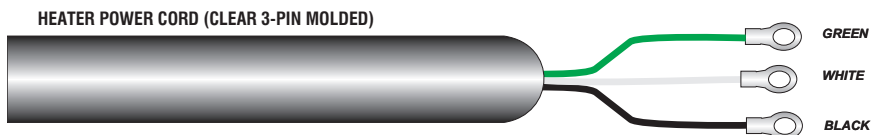

### HEATER - POWER CORD

**Note:** Heater connection is rated for 240VAC / 23Amps maximum.

Securely connect the Black/ 12AWG/ Line 1 wire to one of the heater connectors.  
Securely connect the White/ 12AWG/ Line 2 wire to the second heater connectors.  
Connect the Green/ 10AWG/ Ground wire to an existing ground point (such as a metal enclosure).

\* Connections must be made without twisting or damaging heater posts. USE 2 WRENCHES, one to hold the post, one to tighten the nut.

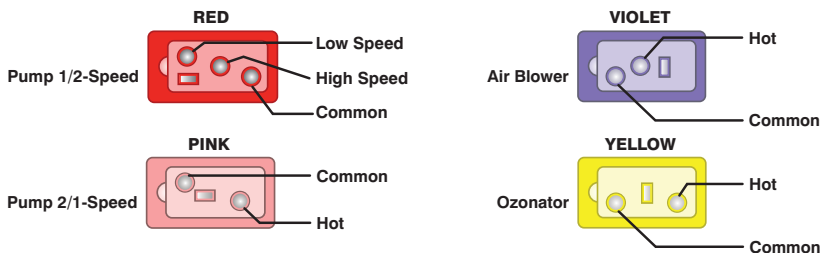

## Wet (Plumbing) Connections

The control system can be installed wherever it may be convenient, however, it is supplied with a pressure switch. Therefore, it is only possible to install the heater on the pressure side of the plumbing system. (If you find it necessary to install the heater on the suction side of the plumbing system, please contact Hydro-Quip for further information).

## Spa Light

Your control may contain a high intensity, low voltage light to enhance nighttime use.

This illustration shows how and where to find the bulb for replacement. It also shows the mounted spa light with a replacement (colored) lens. Colored lenses will further the enhancement of the light. Simply snap on or off to change the mood of your spa.

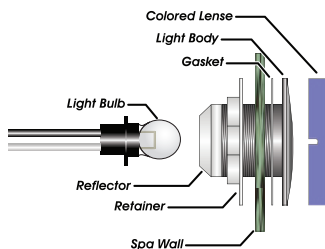



## GFCI

\* This device may be installed in the control box or at the electrical service panel.

The GFCI is a mandatory electrical safety device required for all portable spas and hot tubs as specified in the National Electrical Code Article 680. The GFCI is designed to provide protection against potential electrical shock hazard should ground fault occur.

The installation of a properly sized Ground Circuit and Bonding Circuit is still required as detailed in the Installation Manual. The GFCI in your particular installation may be installed at the electrical service panel, a separate sub-panel or built into your Hydro-Quip spa control system.

Systems with a built-in GFCI meeting the code requirements will be marked on the top of the control panel with identification label.

It is necessary to test the GFCI before each use and at least monthly when the spa or hot tub is not being used regularly.

### Test the device in the following manner:

With the power on, push the "TEST" button; there should be an audible "click", which will disconnect the power to the system. The "RESET" button will pop out slightly.

**CAUTION - If the GFCI fails to operate in this manner, do not use the spa until a qualified technician has corrected the problem.**

! To restore power, press the red "RESET" button in.

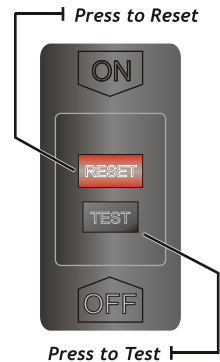

## Pressure Switch

The function of the pressure switch is to turn the heater off if the pumps stops operating or if there is a restricted water flow (dirty filter, obstruction in the spa plumbing etc.)

**IMPORTANT:** After any pressure switch adjustment, it is important to test the control by turning on the pump low speed and heater. While Operating, unplug the pump, the heater must turn off. If the heater stays on, plug the pump back in and readjust the pressure switch to achieve proper operation.

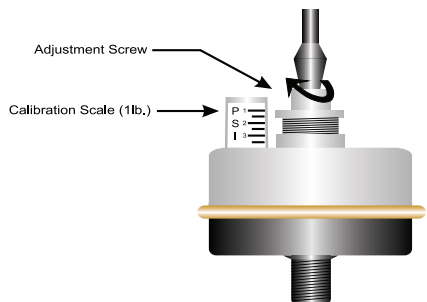

### Adjustment:

- 1) With power to system turned OFF, remove the wires from the pressure switch terminals (secure wires safely to prevent any chance of electrical shock).
- 2) Use Temperature adjustment key to move "set point" temperature to its lowest setting.
- 3) Turn power to the system ON and activate the low-speed pump.
- 4) Place an Ohmmeter across the pressure switch terminals to verify an OPEN circuit.
- 5) Rotate the pressure switch adjustment screw counter-clockwise until the Ohm-meter indicates a CLOSED circuit.
- 6) Turn pump OFF and verify that the pressure switch circuit is once again OPEN.
- 7) Turn power to the system OFF and reconnect pressure switch wires. Reapply power to the system and operate the spa or hot tub as normal.



## System Timer (Setting Filtration)

The system timer provides the most efficient and reliable method to filter and heat your spa by activating the low speed of the jet pump during user selectable time periods. Each tripper represents 15 minutes.

### Setting the Time

Carefully rotate the minute hand clockwise until the appropriate time setting is achieved. Be sure the set point is correctly indexed to reflect AM/PM.

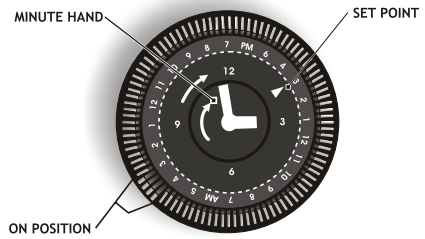

**WARNING - Do not set time by rotating outer dial. Do not rotate minute hand counterclockwise.**

Set the operating times to provide filtration and/or heating for the number of hours per day recommended by your spa manufacturer. We recommend at least two daily operating periods of not less than 1 hour each and spaced no more than 12 hours apart.

Heavy usage of your spa may require longer periods to maintain water clarity and/or heat. Be sure to set your system timer accordingly.

If you happen to live in an area subject to extreme cold weather conditions, your dealer may recommend that you operate your spa on low speed continuously. This can be accomplished simply by setting all of the trippers to the "On" position.

We recommend leaving your spa set to PROGRAM MODE 1 (see page 17) for the most energy conservative operation. This mode will allow you to set operating periods during nonsleeping hours or during low cost energy periods.

We recommend PROGRAM MODE 2 (see page 17) for initial heating of your spa and if you wish the spa to be ready for your enjoyment at any time of the day.

**You do not need to change or override the timers to utilize the jet or blower modes. Timers control only the low speed heat mode.**

## Mode Selection

The System Timer operates in one of two modes. Select the mode that best suites your needs.

**PROGRAM MODE 1** - The system timer will activate the low speed of the jet pump, filtering the water while the pump is running. The water will be heated according to the thermostat setting only while the timer is on. While the timer is off heating and filtration will not occur.

**PROGRAM MODE 2** - Operation is the same as PROGRAM MODE 1 except that while the timer is off, the thermostat will maintain the water temperature by automatically cycling the pump and heater on as needed.

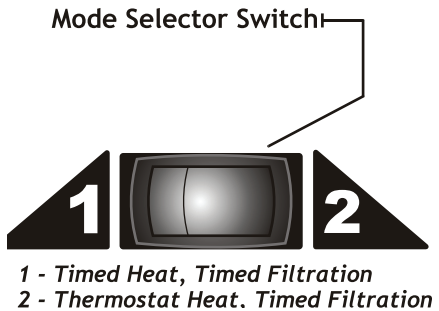

## Heater "ON" Indicator

This indicator light activates when the heater is "on". It is a diagnostic tool for service technicians.

**HEATER  
ON**



## Topside Options

*Used with PS-6002:*



*Used with PS-6003:*



**Hole size 1-1/4"**

## Topside (Optional)

The optional Spaside Control consists of control buttons for activating the equipment, a thermostat and indicator lights (Deluxe models will include an LED temperature readout).

Depending on how your spa is optioned, it will normally have 2 to 4 control buttons. They usually control the Jet Pump, Secondary Jet Pump, Air Blower and Light.



## Topside (Optional) Cont.

Used with PS-6002:

**Command Center**  
2,3,4-button 10' cord  
3-1/4" x 6-1/2"



**Digital Command Center**  
2,3,4-button 10' cord  
3-1/4" x 6-1/2"

**Tecmark**

**Patrol**  
2-button, 6' cord  
3-1/4" x 6-1/2"

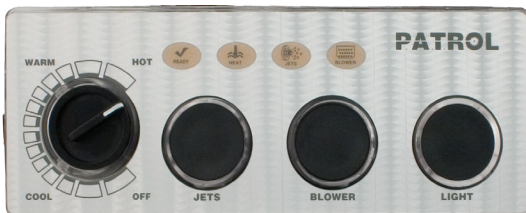

**Patrol**  
3-button, 6' cord  
3-1/4" x 8-1/2"

**Pres-Air-Trol**

## Topside (Optional) Cont.

Used with PS-6002:

**Len Gordon**  
2-button, 6' cord  
3-1/4" x 6-1/2"



**Len Gordon**  
3-button, 6' cord  
3-1/4" x 8-1/2"

**Len Gordon Digital**  
2,3,4-button 6' cord  
3-1/4" x 8-1/2"



**Len Gordon**

Used with PS-6003:



**Command Center**  
2,3,4-button 10' cord  
3-1/4" x 6-1/2"

**Digital Command Center**  
2,3,4-button 10' cord  
3-1/4" x 6-1/2"



**Tecmark**

## Topside (Optional) Cont.

Used with PS-6003:

**Patrol**  
3-button, 6' cord  
3-1/4" x 8-1/2"

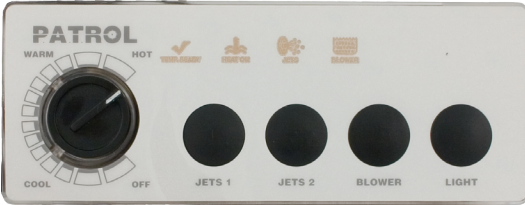
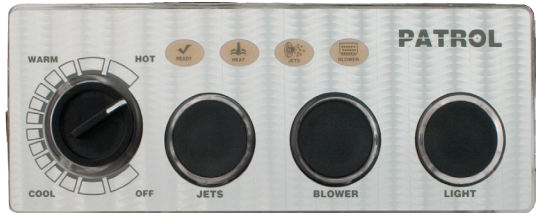

**Patrol**  
4-button, 6' cord  
3-1/4" x 8-1/2"

**Pres-Air-Trol**

**Len Gordon**  
4-button, 6' cord  
3-1/4" x 8-1/2"

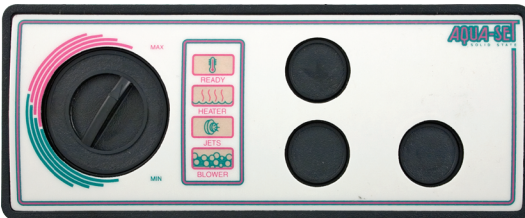
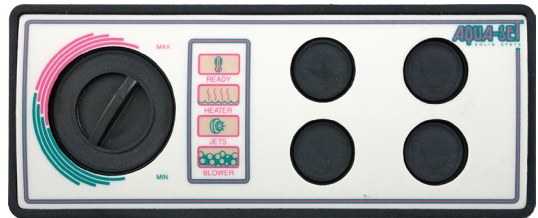

**Len Gordon**  
3-button, 6' cord  
3-1/4" x 8-1/2"

**Len Gordon Digital**  
2,3,4-button 6' cord  
3-1/4" x 8-1/2"



**Len Gordon**

## Thermostat Setting

The Thermostat regulates the water temperature in your spa. It is located on the front panel of the control box or on the optional deluxe Spaside Control. Some spas may have both types.

**NOTE: When operating a spa that utilizes two thermostats, set the one not being utilized, fully counterclockwise.**

Rotating it fully clockwise will activate the heater and allow a maximum temperature of approximately 104°F. A full counterclockwise rotation will shut off the heater.

**Do not expect to feel hot water coming out of the jets while the heater is operating. Refer to "Heater Operation" for information on heat rise.**

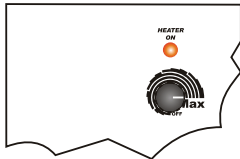

System Mounted Thermostat



Spaside Control Thermostat

## Heater Operation

Your control system may have a convertible heater (120 volts; or 240 volts). Refer to the system data label to determine which, if any, convertible options are available to you. The heater configuration was set at the factory and may have been changed by your installer.

A covered, 300-gallon spa will experience a heat rise approximately as detailed below.

**Your system will operate with one of the following configurations:**

**120 Volts** - The heater will operate on demand at 1500 Watts during low speed pump operation. It will automatically shut off when the high-speed pump or blower is activated. You can expect a heat rise of 1°F to 2°F per hour.

**240 Volt** - The heater will operate on demand at 5500 Watts during high and low speed pump operation. It will continue to operate when the blower is activated. You can expect a heat rise of 6°F to 8°F per hour.

## OPTIONAL EQUIPMENT

### *Cord Adapter Kits:*

Cord Adapter Kits are available which allow you to quickly replace a control system without changing the original cords. These cord adapters allow you to take a 4-pin amp style plug from the component and quickly convert it to the molded lit mini plug for the control system, saving you hours of install time.

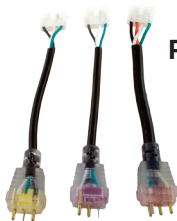

PS-6002

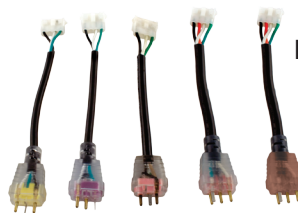

PS-6003



# OPERATIONAL CONSIDERATIONS

The following describes situation you may encounter and situations to be aware of.

## Warm Weather Conditions

Since your spa will normally be expected to maintain warm to hot water ready for use, a great deal of attention has been directed to the **energy conservation** detail of insulation so as to keep electrical costs down. **Energy conservation efficiency** may be achieved by extensive insulation of the skirt, plumbing and spa shell, and in some climates full foam insulation may have been provided.

This **energy conservation** feature may cause an inconvenience during warmer times of the year. During warm periods of the year, the temperature within the equipment compartment can elevate to a point that the pump will automatically turn off for a short period of time (15-30 minutes) to allow the pump to cool down before automatically restarting. This cool down feature will not harm your spa but serves only to protect the pump from damage and as an indicator that it is too hot. To minimize this occurrence, refrain from using your Hydrotherapy Jets for prolonged periods of time during warm seasons.

The jet pump chosen for your spa has been specifically sized for *maximum performance* and your Hydrotherapy enjoyment.

## Filtration System

Please refer to your Spa Manufacturer's owner's manual regarding the operation, maintenance, and cleaning of your filtration system.

Dirty or clogged filters can cause a water flow restriction and you may experience difficulty in reaching and/or maintaining desired heat levels.

## Winterizing

When freezing weather and/or power losses are expected, contact your local spa dealer for freeze protection or winterizing recommendations for both the spa and the equipment system. Freeze related damage is not covered by the warranty.

## Chemical Water Treatment

Your dealer is familiar with local water conditions and which chemicals are compatible with and designed specifically for your spa. This is the best person to advise you on proper water quality management.

The one thing you can do to insure years of trouble free equipment operation is to maintain proper water chemistry.

Two basic goals of the chemical water treatment are sanitizing and balancing the water. Sanitizing simply means keeping the water free from living microorganisms including algae, bacteria, and viruses. The current most popular chemicals for sanitizing include chlorine, bromine, and ozone.

Balancing water means establishing a balance among pH, total alkalinity, and total hardness. Water that is unbalanced can corrode the spa and it's support equipment or leave deposits of minerals. Properly balanced water is essential to allow the sanitizing chemical to work effectively. There are numerous chemical additives to help you in controlling pH, total hardness, and total alkalinity. **NEVER** use softened water when filling your spa. Softened water is extremely corrosive to metal parts of the spa equipment and may lead to unforeseen failure.

Sometimes, despite your most diligent efforts, your water may become too far out of balance to be managed chemically. At this point it is probably better to drain and clean the spa and start over with fresh water.

Equipment failure caused by improper water chemistry will not be covered under warranty.

# TROUBLESHOOTING

*The following describes situations and possible solutions to common problems you may encounter as a spa owner. Note: your system may not include all components listed.*

## Nothing Operates

**Main Breaker is OFF** - Set to On.

**Sub-Panel Breaker Off** - Set to On.

**Equipment GFCI Off** - Set to On.

**Components not plugged in** - Plug in components.

**Power cord not plugged in** - Plug in power cord.

**Overheat Protection Switch Tripped** - Contact your local dealer.

## No, Low or Surging Water Flow

**Air Lock in Plumbing System** - "Bleed" the system.

**Restricted Flow** - Insure that the water shut-off valves are open and that suction fittings are not blocked by debris.

**Dirty Filter** - Clean or replace filter.

**Low Water Level** - Increase water level to recommended level.

## No Low Speed Pump Operation

**Timer Not Programmed** - Set function mode to desired setting and program timer.

**Overheat Protection Switch Tripped** - Press button to reset.

**Mode Switch Set in Mode 2** - Thermostat needs to be turned up to desired temperature.

**Pump Not Plugged-In** - Plug in the Pump.

**Auxiliary Fuse Blown** - Contact you local dealer.

## No Jets or Blower Operation

**Air Button / Air Switch Hose Not Connected** - Connect hose.

**Blower or Pump Not Plugged-In** - Plug in the Blower or Pump.

**Overheat Protection Switch Tripped** - Press button to reset.

**Auxiliary Fuse Blown** - Contact you local dealer.

## No Therapy Jet Operation

**Water Shut-Off Valves are Closed** - Open Shut-Off valves.

**Dirty Filter** - Clean or replace filter.

**Jets Not Properly Adjusted** - Adjust Jets properly.

**Diverter Valve Not Properly Adjusted** - Adjust diverter valve properly.

**Thermal Overload Tripping** - Check for restricted flow of water.

**Overheat Protection Switch Tripped** - Press button to reset.

**Air Button / Switch Hose Not Connected** - Connect hose.

## No Light Operation

**Light Bulb Defective** - Replace bulb or contact your local dealer.

**Reflector has Fallen Off** - Replace deflector or contact your local dealer.

**Light Not Plugged-In** - Plug in the Light.

**Air Button / Switch Hose Not Connected** - Connect hose.



# TROUBLESHOOTING CONT.

## Water Leaks

- Spa Overfilled** - *Adjust water level.*
- Too Many People in the Spa** - *Adjust water level.*
- Drain-Valve Left Open** - *Close drain valve.*
- Couplings or Unions Loose** - *Tighten or contact your local dealer.*
- Pump Seal Leaking** - *Contact your local dealer.*
- Plumbing / Connections Leaking** - *Contact your local dealer.*
- Water Leaking from Spaside Control** - *Contact your local dealer.*
- Water in Air Blower Plumbing** - *Contact your local dealer.*

## No Heat

- Temperature Not Set Correctly** - *Adjust Thermostat setting.*
- Overheat Protection Switch Tripped** - *Press button to reset.*
- System in Wrong Mode** - *120V Systems will/ not heat if High Speed or Blower is on.*
- No Power** - *Reset breaker at service panel.*
- Low Water Flow** - *Clean or Replace filter.*
- Pressure Switch Not Adjusted Properly** - *Contact a qualified technician.*

## High Heat

- Temperature Sensor Not in Dry-Well** - *Place sensor in dry-well.*
- Temperature Set Too High** - *Adjust Thermostat Setting.*
- High Ambient Temperature** - *Remove spa cover.*

## GFCI Trips Occasionally

- Lighting or Electrical storm, Power Surge, Extremely Humid Conditions or Radio Frequency interference** - *Reset GFCI NOTE: GFCI must be properly grounded or bonded.*

## GFCI Trips Immediately

- Defective Component** - *Contact a qualified service technician or the factory for assistance.*

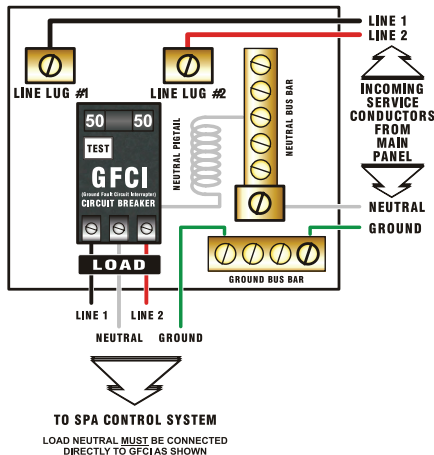

# SYSTEM DATA LABEL

The system data label is located on the control box. This label is very important and contains information you will need to establish your electrical service. The voltage and amperage ratings are shown on the bottom of the label. Product, Model, Serial and Code numbers are also shown on the label.

**Note:** This information will be necessary if you should ever have to request warranty or any other type of service.



**HYDROQUIP**  
THE SMART CHOICE™  
Corona, CA 92880 | www.hydroquip.com

<b>ORDER CODE:</b>	<b>PS-600x</b>
<b>MODEL CODE:</b>	<b>HOR03-xxxx-</b>
<b>VOLTS:</b>	<b>120      240</b>
<b>AMPS:</b>	<b>16          40/48</b>
<b>PRODUCT:</b>	<b>HQ-6000</b>
	<b>1 PHASE - 60Hz</b>

Refer to NEC for Breaker Sizing

# WARRANTY INFORMATION

To all original purchasers, HydroQuip, warrants this product to be free from defects in material and workmanship for a period of 3 years from the date of purchase.

Hydro-Quip will, at its discretion, repair or replace any part which has been found to be defective.

This warranty excludes damage as a result of: normal wear, freezing, low voltage, chemical abuse, accident, negligence, alteration, improper installation, use or care.

To obtain warranty service, return defective products within the warranty period to your dealer.

The Hydro-Quip Limited Warranty is for service on the control box and heater only. The topside is supported by its original manufacturer's warranty. Purchaser is responsible for removal or reinstallation labor, freight charges, or any other such costs incurred in obtaining warranty service.

Hydro-Quip assumes no responsibility for incidental or consequential damages. Some states do not allow the exclusion of incidental or consequential damages, so the above limitations and exclusions may not apply to you. This warranty gives you specific legal rights and you may also have other rights, which vary from state to state.

If you are the end user for this control system, the spa dealer may provide a different warranty; contact your spa dealer for details and warranty information.



