



EasyTouch® Wireless Control Panel



Installation and User's Guide

IMPORTANT SAFETY INSTRUCTIONS
READ AND FOLLOW ALL INSTRUCTIONS
SAVE THESE INSTRUCTIONS

© 2005 Pentair Water Pool and Spa, Inc. All rights reserved

This document is subject to change without notice

1620 Hawkins Ave., Sanford, NC 27330 • (919) 566-8000
10951 West Los Angeles Ave., Moorpark, CA 93021 • (805) 553-5000

Trademarks and disclaimers: EasyTouch, IntelliChlor, IntelliFlo, QuickTouch and the Pentair Water Pool and Spa logo are trademarks of Pentair Water Pool and Spa, Inc. Other trademarks and trade names may be used in this document to refer to either the entities claiming the marks and names or their products. Pentair Water Pool and Spa, Inc. disclaims proprietary interest in marks and names of others.



Contents

IMPORTANT SAFETY PRECAUTIONS	iii
EasyTouch Wireless Control Panel Kit Contents	v
Related Manuals	v
EasyTouch Accessories	v
Technical Support	vi
Section 1: EasyTouch Wireless Control Panel Overview	1
Introduction	1
EasyTouch Wireless Control Panel Overview	2
EasyTouch Wireless Control Panel Buttons and LEDs	3
EasyTouch Wireless Control Panel Display	5
Battery Overview	6
Safety Precautions when using batteries	6
Checking the battery charge	6
Power save options	7
Backlight Options	7
Installing batteries	7
Setting up the EasyTouch wireless control panel for the first time	9
Synchronizing control panels	10
Quick Start Spa and Pool Operations	11
Heat your spa or pool	11
Adjust your spa or pool heat settings	11
Switch on lights manually	12
Using the Once Only timer feature	12
Schedule start and stop times for equipment	13
Program your Spa or Pool	13
Schedules	13
Setting the Egg Timer Feature	14
Section 2: Setting up EasyTouch	15
Setting up the System for the First Time	15
EasyTouch Menu Structure	17
EasyTouch Menus	18
Main Screen	18
Lights Menu	19
Heat Menu	20
Pool Temp/Src	20
Spa Temp/Src	20
Delay Cancel Menu	21
Schedules Menu	22
Using the Schedules menu	22
Program your Spa or Pool	23
Schedules	23
Using the Once Only feature	24
Using the Egg Timer (count-down) Feature	25
Settings Menu: Clock	26
Settings Menu: IntelliFlo 4	27
Settings Menu: IntelliChlor	28
Settings Menu: Circuit Names	29
Labeling Circuit Buttons on the Wireless Control Panel	29
Hi-Temp/Lo-Temp Controls for Single Body System	29
EasyTouch Circuit Names	30

Contents

Section 2: EasyTouch Menus (Continued)

Settings Menu: Circuit Types	31
Assigning Circuit Types	31
Freeze Protection	31
Circuit Types	31
Preset Circuit Types	32
Settings Menu: Custom Names	33
Settings Menu: Valves	33
Settings Menu: 2-Speed Pump	34
Settings Menu: Solar	34
Settings Menu: Delays	35
Settings Menu: F° / C° (Celsius/Fahrenheit)	36
Settings Menu: iS4 Spa-Side Remote Controller	36
Settings Menu: QuickTouch (QT4) Wireless Remote	37
Settings Menu: Man Heat (Off/On)	38
Settings Menu: Calibration	38
Settings Menu: Erase EEPROM (Erase System Memory)	39
Settings Menu: Backlight	39
Settings Menu: Power Save	40
Settings Menu: Wireless Addr	40
Spa Side [On/Off]	40
Diagnostics Menu: Software Rev	41
Diagnostics Menu: Bootloader Rev	41
Diagnostics Menu: Self Test	41
Diagnostics Menu: Chlorinator	42
Diagnostics Menu: Water Temp	42
Diagnostics Menu: Solar Temp	42
Diagnostics Menu: Air Temp	43
Diagnostics Menu: Disp Codes	43
Diagnostics Menu: Cir Names: [Off/On]	43
Diagnostics Menu: Reset System	43
Diagnostics Menu: Flash Update	44
Power OFF	44
Section 3: Troubleshooting	45
Troubleshooting	45
Frequently Asked Questions (FAQ)	45
How do I setup a two-speed pump?	45
Can I switch the heater on and change the temperature from the spa?	45
How do I switch on solar heating?	45
EasyTouch Error Messages	46
Self Test Error Codes	46
Maximum Programs Exceeded	47
IntelliChlor Error Messages	47
System Problem Diagnosis	48
Problem: iS4 fails to operate.	48
Problem: The Quick Touch remote will not work, or will not work dependably	49
Section 4: EasyTouch Transceiver Installation	51
Installing the EasyTouch Transceiver	51
EasyTouch wireless control panel kit	51
Mounting the EasyTouch Transceiver	51
Connecting the Transceiver to the Load Center	53
Glossary of Terms	55

IMPORTANT SAFETY PRECAUTIONS



Important Notice:

Attention Installer: This manual contains important information about the installation, operation and safe use of this product. This information should be given to the owner and/or operator of this equipment.

WARNING - Before installing this product, read and follow all warning notices and instructions which are included. Failure to follow safety warnings and instructions can result in severe injury, death, or property damage. Call (800) 831-7133 for additional free copies of these instructions.

WARNING - Water temperature in excess of 100 degrees Fahrenheit may be hazardous to your health. Prolonged immersion in hot water may induce hyperthermia. Hyperthermia occurs when the internal temperature of the body reaches a level several degrees above normal body temperature of 98.6° F (37° C). The symptoms of hyperthermia include drowsiness, lethargy, dizziness, fainting, and an increase in the internal temperature of the body.

The effects of hyperthermia include: 1) Unawareness of impending danger. 2) Failure to perceive heat. 3) Failure to recognize the need to leave the spa. 4) Physical inability to exit the spa. 5) Fetal damage in pregnant women. 6) Unconsciousness resulting in danger of drowning.

WARNING - To reduce the risk of injury, do not permit children to use this product unless they are closely supervised at all times.

WARNING - The use of alcohol, drugs, or medication can greatly increase the risk of fatal hyperthermia in hot tubs and spas.

WARNING - Control System is intended to control heaters with built-in high limit circuits **ONLY**. Failure to do so may cause property damage or personal injury.

WARNING - Do not use this product to control an automatic pool cover. Swimmers may become entrapped underneath the cover.

WARNING - For units intended for use in other than single-family dwellings, a clearly labeled emergency switch shall be provided as part of the installation. The switch shall be readily accessible to the occupants and shall be installed at least 10 feet (3.05 m) away, adjacent to, and within sight of, the unit.

CAUTION - Except for listed spa-side remote controls, install a minimum of five (5) feet from the inside wall of the pool and spa.

IMPORTANT SAFETY PRECAUTIONS (Continued)

General Installation Information

1. All work must be performed by a licensed electrician, and must conform to all national, state, and local codes.
2. Install to provide drainage of compartment for electrical components.
3. If this system is used to control underwater lighting fixtures, a ground-fault circuit interrupter (GFCI) must be provided for these fixtures. Conductors on the load side of the ground-fault circuit-interrupter shall **not** occupy conduit, junction boxes or enclosures containing other conductors unless such conductors are also protected by a ground-fault circuit-interrupter. Refer to local codes for details.
4. A terminal bar stamped  is located inside the supply terminal box. To reduce the risk of electric shock, this terminal must be connected to the grounding means provided in the electric supply service panel with a continuous copper wire equivalent in size to the circuit conductors supplying this equipment (no smaller than 12 AWG or 3.3 mm). The bonding lug(s) provided on this unit are intended to connect a minimum of one No. 8 AWG for US installation and two No. 6 AWG for Canadian installations solid copper conductor between this unit and any metal equipment, metal enclosures or electrical equipment, metal water pipe, or conduit within 5 feet (1.5 m) of the unit.
5. The electrical supply for this product must include a suitably rated switch or circuit breaker to open all ungrounded supply conductors to comply with Section 422-20 of the National Electrical Code, ANSI/NFPA 70.1987. The disconnecting means must be readily accessible to the tub occupant but installed at least 10 ft. (3.05 m) from the inside wall of the pool.
6. Supply conductor must be sized to support all loads. Maximum supply conductor current must be 125 Amps at 125 VAC.

Canada - Industry Canada (IC) - This device complies with RSS210 of Industry Canada. (1999). Operation is subject to the following two conditions: (1) this device may not cause interference, and (2) this device must accept any interference, including interference that may cause undesired operation of the device.

FCC Standard - 47 CFR Part 15, Subpart C (Section 15.247). This version is limited to chapter 1 to chapter 11 by specified firmware controlled in the U.S.A.

Instruction to user - This equipment has been tested and found to comply with the limits for a Class B digital device, pursuant to Part 15 of the FCC Rules. These limits are designed to provide reasonable protection against harmful interference in a residential installation. This equipment generates, uses and can radiate radio frequency energy and, if not installed and used in accordance with the instructions, may cause harmful interference to radio communications. However, there is no guarantee that interference will not occur in a particular installation. If this equipment does cause harmful interference to radio or television reception, which can be determined by turning the equipment off and on, the user is encouraged to try to correct the interference by one or more of the following measures:

- Reorient or relocate the receiving antenna.
- Increase the separation between the equipment and receiver.
- Connect the equipment into an outlet on a circuit different from that to which the receiver is connected.
- Consult the dealer or an experienced radio/TV technician for help.

Note: The user is cautioned that changes and modifications made to the equipment without the approval of the manufacturer could void the user's authority to operate this equipment.

EasyTouch Wireless Control Panel Kit Contents

The following items are included in the EasyTouch wireless control panel kit. If any items are missing please contact Pentair Technical Support (see page vi).

- EasyTouch wireless control panel
- Four AA-size alkaline batteries
- EasyTouch transceiver module (with four plastic anchors and mounting screws)
- EasyTouch Wireless Control Panel User's and Installation Guide (this manual)

Related Manuals

- EasyTouch 8 and 4 Pool and Spa Control System User's Guide (P/N 520584)
- EasyTouch Indoor Control Panel User's and Installation (P/N 520617)
- EasyTouch 8 and 4 Installation Guide (P/N 520583)

EasyTouch Accessories

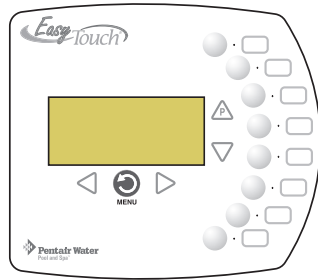

EasyTouch 8 Indoor Control Panel (P/N 520549)

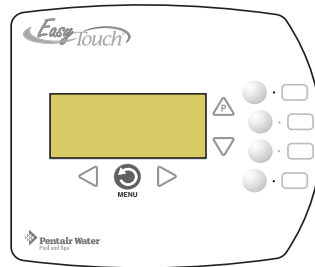

EasyTouch 4 Indoor Control Panel (P/N 520548)



iS4 Spa-Side Remote Controller (P/N 520094)



QuickTouch Remote Controller (P/N 520148)

EasyTouch Accessories (continued)

EasyTouch Indoor Control Panel, 4 Circuits	(P/N 520548)
EasyTouch Indoor Control Panel, 8 Circuits	(P/N 520549)
EasyTouch Wireless Control Panel, 4 circuits	(P/N 520546)
EasyTouch Wireless Control Panel, 8 circuits	(P/N 520547)
iS4 Four-Function Spa-Side remote, 150 ft. cable	(P/N 520094)
Two-Speed Three HP Relay up to three additional valve actuators	(P/N 520198)
Three HP Power Relay	(P/N 520106)
QuickTouch four-function wireless remote kit with transceiver assembly	(P/N 520148)
IntelliChlor Acid Cleaning Kit	(P/N 520670)
IntelliChlor Spacer pass-through cell for new pool start-up	(P/N 520588)

Technical Support

Contact Technical Support at:

Sanford, North Carolina (8 A.M. to 5 P.M.)

Phone: (800) 831-7133

Fax: (919) 566-8920

Moorpark, California (8 A.M. to 5 P.M.)

Phone: (800) 831-7133 (Ext. 6312)

Fax: (805) 553-5515

Web sites: visit www.pentairpool.com and www.staritepool.com

EasyTouch Wireless Control Panel Overview

Introduction

The EasyTouch wireless control panel gives you the freedom to control your pool and spa daily operations from around your pool and spa area. The wireless device can operate up to 300 feet from the EasyTouch transceiver module which is typically located near the EasyTouch load center. There is enough battery power to operate the whole summer season without changing batteries, Using the power saving menu options you can also reduce power consumption and extend battery life. The EasyTouch wireless control panel is water resistant, however, is not intended to be submersible.

The EasyTouch wireless control panel is designed to be used with the EasyTouch 8 or EasyTouch 4 system. For more information about operating the EasyTouch system, refer to the EasyTouch User's Guide.

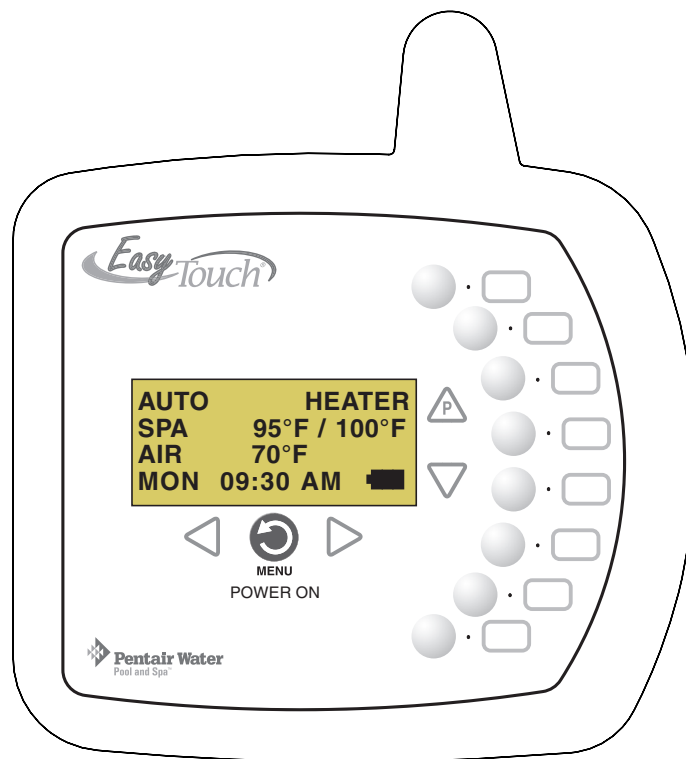

EasyTouch Wireless Control Panel (eight auxiliary circuits)

EasyTouch Wireless Control Panel Overview

The EasyTouch wireless control panel makes it easy for you to control your pool and spa daily operations from around your pool area. Using the “Pool” and “Spa” buttons allows one touch control to heat and filter your spa and pool. EasyTouch automatic system operations can be performed either from the EasyTouch wireless control panel or the outdoor control panel at the equipment pad.

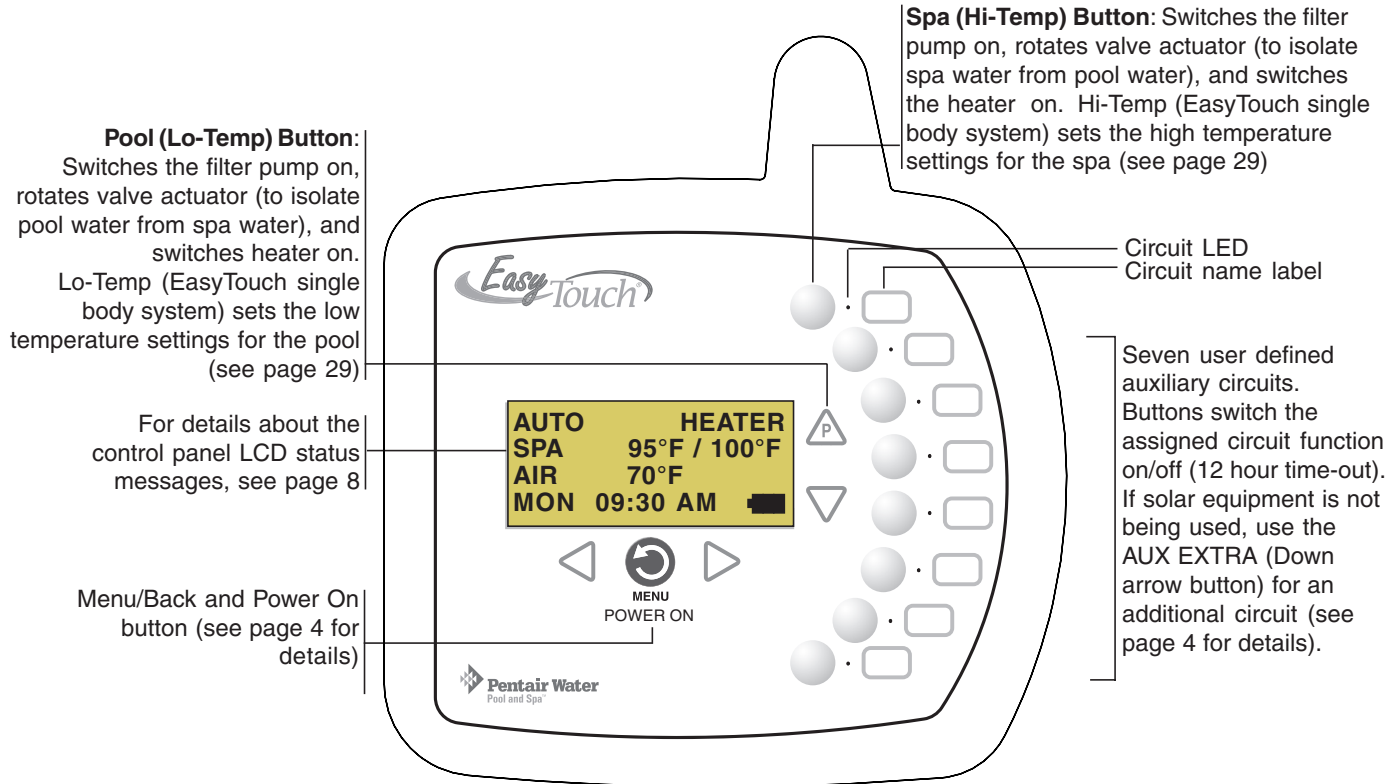

EasyTouch Wireless Control Panel (8 circuits) - (P/N 520547)

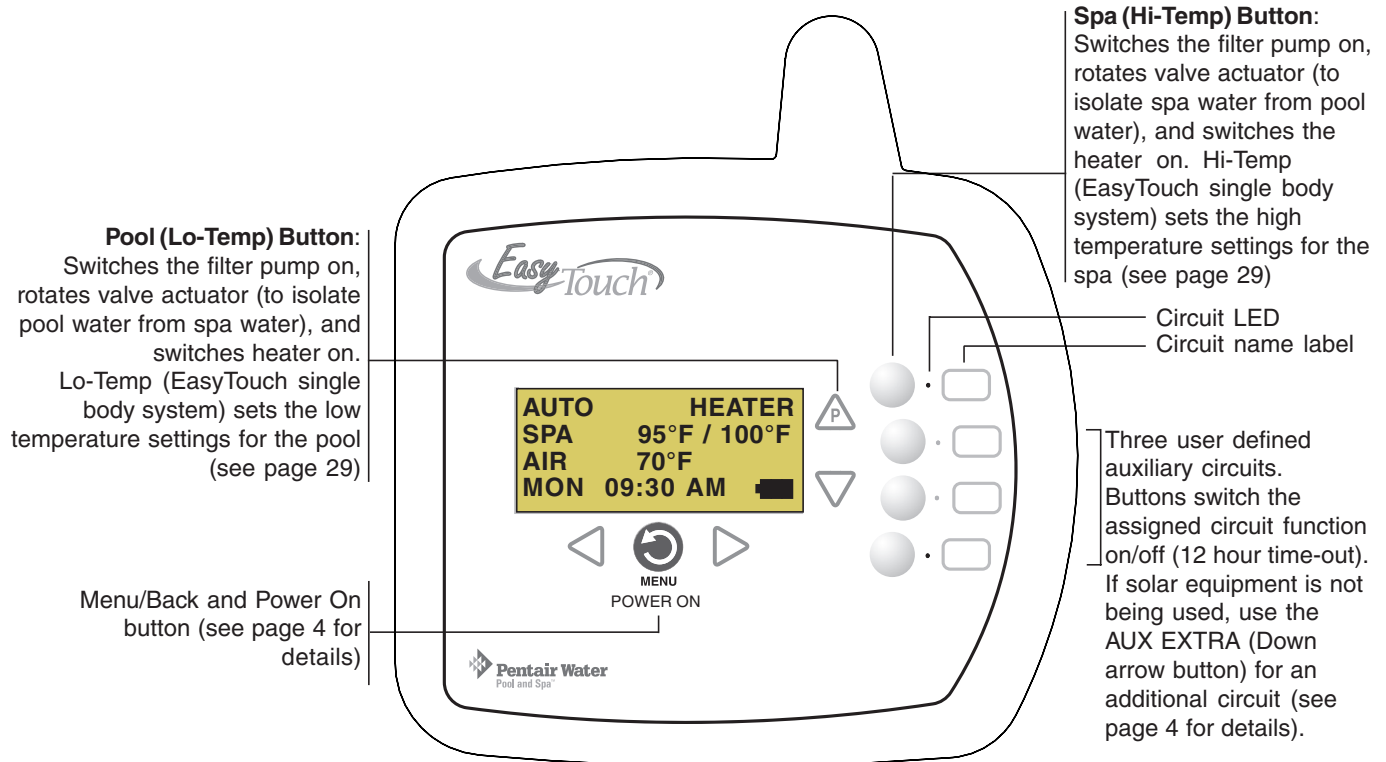

EasyTouch Wireless Control Panel (4 circuits) - (P/N 520546)

EasyTouch Wireless Control Panel Buttons and LEDs

You can fully automate your pool, spa, and lighting operations from the EasyTouch wireless control panel or from the outdoor control panel located at the pool equipment pad. The EasyTouch menu options lets you create customized schedules for your pool and spa equipment, heat temperatures, and chlorination settings to switch on and off at a set day and time. Scheduled automatic operations can be performed at the EasyTouch wireless control panel or from the outdoor control panel. For menu options, refer to “EasyTouch Menu Structure,” on page 17. Before operating the EasyTouch wireless control panel, familiarize yourself with the LCD status messages and operating buttons.

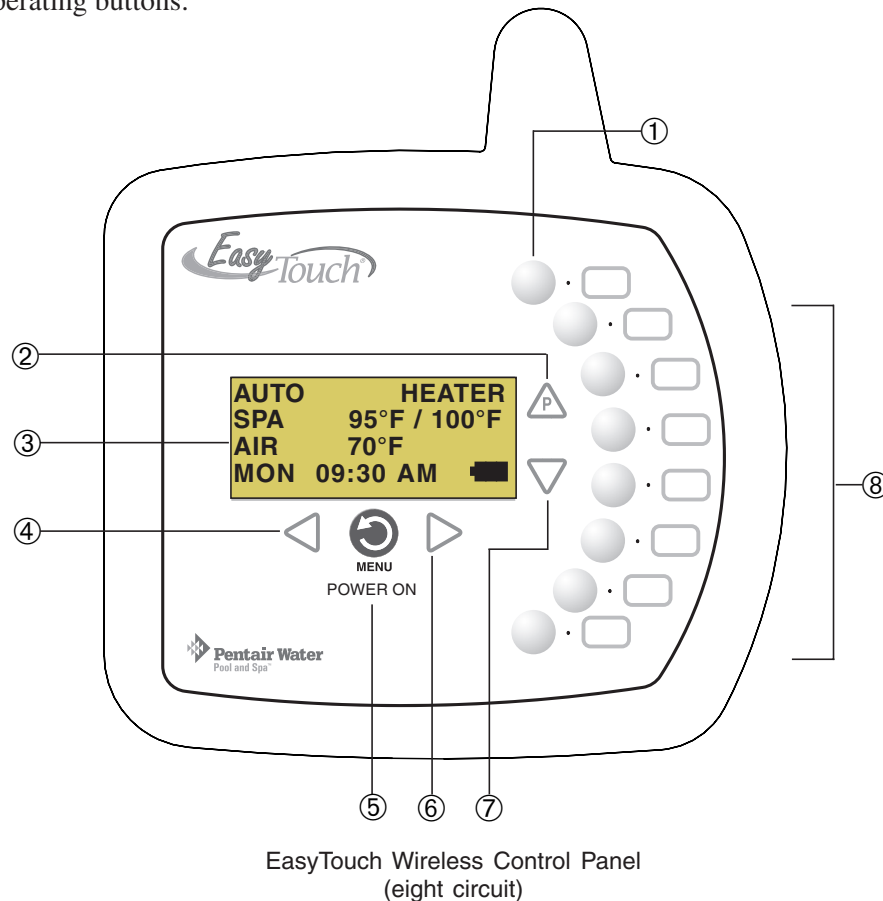

Control Panel Buttons and LEDs

- ①  **Spa button/LED:** For spa operations. Press this button to rotate valves and activate the filter pump automatically so that only the spa water is circulated through the system. If the heater is enabled, pressing this button also switches the heater on (if enabled in the Heat menu). When this button is pressed the circuit is activated, the LED is on and “SPA” is displayed on the screen with the current and set point water temperatures. The default time before the filter pump will switch off is 12 hours. When this button is pressed, the LEDs on the outdoor control panel Filter Pump (F) button, Valves (V) button, and Heater button (if enabled in the Heat menu) will be on.

- ②  **Pool Button:** For pool operations. Press this button so that only the pool water is circulated through the system. Note that the filter pump will switch off while the pool/spa valves are rotating into position. If the heater is enabled, pressing this button also switches the heater on (if enabled in the Heat menu). When this button is pressed the circuit is activated and “POOL” is displayed on the screen with actual and set point water temperatures. The default time before the filter pump will switch off is 12 hours. When this button is pressed, the LEDs on the outdoor control panel Filter Pump (F) button, Valves (V) button, and Heater button (if enabled in the Heat menu) will be on.

Controls and Buttons and LEDs (Continued)

Pool button (Continued)

- **Single-Speed Filter Pump:** If the pump is currently off, press the Pool button to switch the pump on. Press the Pool button again to switch the pump off. However, if the heater is operating, and a delay is enabled for valves, this allows the heater to cool down (heater cool-down), then when you press the Pool button to switch off the pump, only the heater will turn off, then the filter pump will automatically switch off after 10 minutes to allow the heater to cool down. Pentair heaters do not require a cool down time. To override the heater cool-down process, press the Pool button again to switch off the pump.

- **Two-Speed Filter Pump:** Press the Pool button to switch the two-speed pump on in high speed. Press the Pool button again to run the pump in low speed. In order to use the “2-Speed Pump” menu assignments (see page 34), the 2-Speed relay option must be installed in the EasyTouch Load Center.

Notes about Freeze Protection: This function protects the pool, plumbing, and equipment against freeze damage. If the outside air temperature sensor falls below 36° F, “Freeze Protection” is activated and the Filter Pump relay is switched on to circulate the pool water. To enable freeze protection for a circuit, see “Settings Menu: Circuit Types,” on page 31.

③ **Liquid Crystal Display (LCD):** The main system display consists of a 16 x 4 alphanumeric character LCD with EL backlighting for easy viewing of the menu items, and status messages. Press the Menu button twice to refresh the display. For EasyTouch main screen status information, see page 5. For details about the battery status icon, see page 6.

④  **Left button:** Use the Left button to scroll through sub-menu selections, setting and values. While editing settings, press and hold the Left button to fast reverse through settings and values.

⑤  **Menu/Back and Power On button:** This button has three functions. Use this button to access the menu options, access a previous menu level or item and switch power on to the wireless device. The device can be manually switched off using the “Power Off” menu option (see page 44 for details). Use the Menu button to access the EasyTouch menu system, save and exit settings. Control panel buttons are disabled while in the menu. Use this button to exit from main menu or sub-menu items. Pressing the Menu button while in a menu item will return to the main screen. If no menu activity is detected after five minutes, the main screen is displayed. All menu settings are permanently saved and retained in the control panel even after power is removed from the device.

⑥  **Right button:** Use the Right button to select a sub-menu item for editing. After pressing the Menu button to access the main menu items, use the Right button to select the menu item and access the sub-menu items for adjustment. For convenience, while editing a settings, press and hold the Right button to fast forward through settings and values.

⑦  **Up/Down buttons:** Use the Up and Down buttons to scroll through the main menu items and to adjust or change settings. Use these buttons after pressing the Menu button to access the main menu items. While editing settings, press and hold the Up or Down button to fast forward or fast reverse through settings and values. The down arrow button has a second function



Down arrow button (Aux Extra): This button switches the assigned circuit on or off. This “extra” auxiliary circuit shares the solar circuit and is only available if the solar output plug (J17) on the motherboard is not being used for solar equipment. Refer to the EasyTouch User’s Guide (P/N 520584) for more information.

Controls and buttons (Continued)

- ⑧  **AUX buttons/LEDs:** The auxiliary output circuit buttons operate the pool and spa system valves, lights and other equipment. These auxiliary (AUX) circuits are assigned in the “Circuit Type” menu, see page 31 for details. There are three auxiliary circuits (AUX 1- 3) on the EasyTouch 4 wireless control panel and seven auxiliary circuits (AUX 1- 7) on the EasyTouch 8 wireless control panel. The Down arrow button can also be used as an “extra” auxiliary circuit if solar equipment is not being used. Refer to “Down arrow button” on page 4 for more information. Labels can be affixed next to each auxiliary button to identify the circuit function. When an auxiliary circuit is activated or the button is pressed, the LED is on. Pressing an auxiliary circuit button will activate the corresponding circuit in either “Auto” or “Service” mode. When a circuit relay is switched on manually, it remains on until either you switch it off manually, or the next time the relay is scheduled to be switched off. For example, if the filter pump is scheduled to automatically run from 9:00 AM to 5:00 PM daily then the filter pump is switched on manually at 9:00 PM, it will run continuously until the next day at 5:00 PM then switch off. The schedule will then continue from then on.

EasyTouch Wireless Control Panel Display

The EasyTouch wireless control panel screen displays when the system is in automatic mode (AUTO) or in service mode (SERVICE). Service mode is enabled from EasyTouch outdoor control panel at the pool equipment pad. The following describes the main status screen.

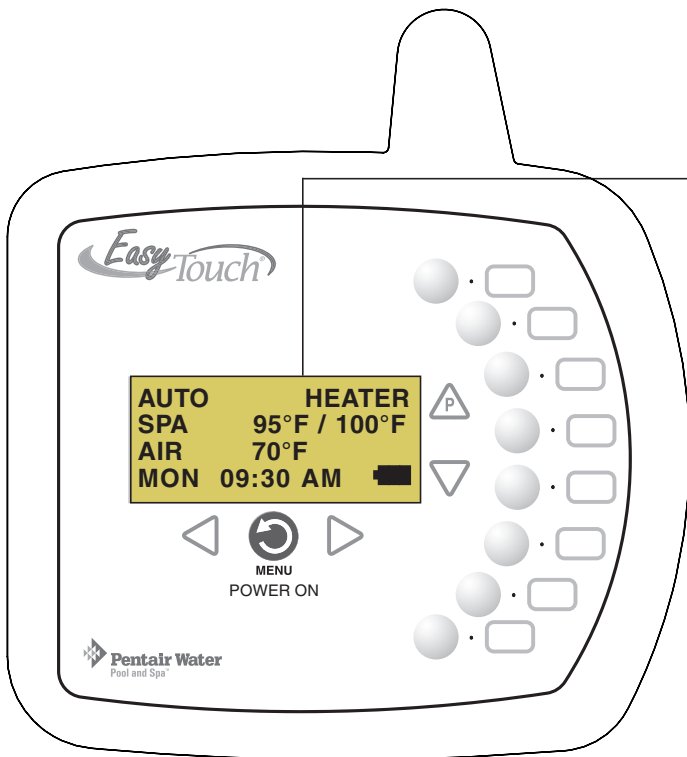

AUTO (Automatic): The system is in normal operating mode. Scheduled programs will run automatically.

HEATER: Displays the heat source (**Off, Heater, Solar Prf., Solar**) as specified in the Heater menu settings (see page 20).

POOL (Spa): Indicates that the Valves (V) button is in “Pool” or “Spa” mode and the Filter Pump (F) button has been pressed to switch on the filter pump. If this display line is blank, it indicates no spa or pool function is active. For an EasyTouch single body system, Hi-Temp (Spa) / Lo-Temp (Pool) sets the temperature settings (see page 29)

95° F / 100° F: Displays the actual spa or pool water temperature (95° F) and the set point temperature (100° F) as set in the “Heater” menu.

AIR: Displays the actual outside air temperature (70° F) as read by the air sensor located near the EasyTouch Load Center.

Date and Time: Displays the EasyTouch system day and time as specified in the “Clock” menu settings (see page 26).

 **Battery icon:** Displays the available battery power usage for the device. See page 6 for details.

Battery Overview

The average battery life for the EasyTouch wireless control panel can last the summer season with normal use. Battery life varies depending on the type of batteries used and the amount of usage. The following battery types are compatible with the EasyTouch wireless control panel:

- AA-size alkaline battery (quantity 4 provided in the kit)
- AA-size Ni-MH rechargeable battery (quantity 4, bought separately)

Safety Precautions when using batteries

Read the following important information before installing batteries into the EasyTouch wireless control panel.

- Never use batteries with split or peeling outer casings
- Never use combinations of different types of batteries or new and used batteries together
- Do not use manganese or Ni-Cd batteries
- Ensure that batteries poles are clean. Dirty poles can shorten battery life
- The time for which AA-size alkaline batteries can be used vary depending on the brand. Some brands may provide less power than others. Note that the time Alkaline batteries can be used decreases in cold conditions (0° C to 10° C (32° F to 50° F)). Therefore, it is recommended to use AA-size Ni-MH batteries in the unit.
- When first purchased, or if left unused for a long period, the amount of time that the AA-size alkaline, Ni-MH, or rechargeable batteries can be used, may be shortened.

Checking the battery charge

A check battery status icon displays on the main screen of the EasyTouch wireless control panel. The check battery icon is located in the lower right corner of the main screen.

AUTO	HEATER
SPA	95°F / 100°F
AIR	70°F
MON 09:30 AM	

Check battery icons



Ample battery charge.



Sufficient charge left in the batteries to operate the unit. The unit's estimated battery life varies greatly depending on use and backlight display time (see page 7).



Batteries are depleted. Before the batteries are completely depleted this icon will start flashing, indicating that the LCD will shortly go blank and the EasyTouch wireless will stop working. Replace or recharge the batteries. Depending on the type of batteries installed, this icon may display more quickly.

Power Save Options

Use the power save function to reduce power consumption and extend battery life. The power save options are:

- **Idle Time:** If there is no control panel activity, the idle time can be set to 60 seconds (default), 30 seconds, or five minutes before it shuts down. The default time is 60 seconds. For information about accessing the idle time options menu, see page 40.

Note: If the unit is not used for 60 seconds the power save function switches off the unit. To switch the unit on, press the POWER ON button (see page 4).

Backlight Options

Use the backlight on time power save options to reduce power consumption and extend battery life. To access the Backlight options menu, see page 39. The backlight options are:

- **On Time:** Backlight is on for 60 seconds, 30 seconds, five minutes, or off. The default setting is 30 seconds.
- **Brightness:** Backlight brightness can be set to low, medium or high. The default setting is medium.

Installing Batteries

The EasyTouch wireless control panel is shipped with four AA-size alkaline batteries. Before using the unit install the batteries.

To install batteries:

1. Place the EasyTouch control panel face down on a flat clean surface. Remove the six screws securing the battery cover. Set the cover aside.

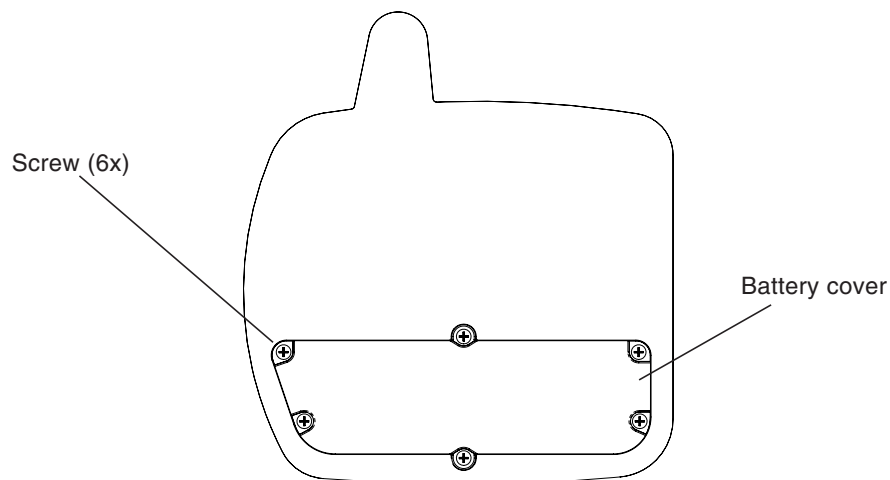

Easy Touch Control Panel (rear view)

Installing batteries (Continued)

2. Load the four batteries into the battery compartment. Orient the positive polarity end of each battery as shown below.

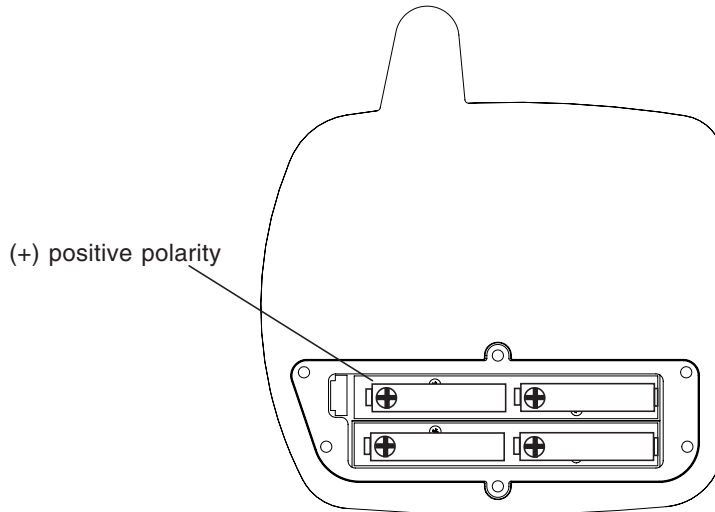

3. Install the battery cover and secure with the six screws. Make sure that the battery cover is secure and that all the screws are hand tightened. **CAUTION - DO NOT OVERTIGHTEN THE SCREWS. OVERTIGHTENING THE SCREWS CAN DAMAGE THE UNIT.**

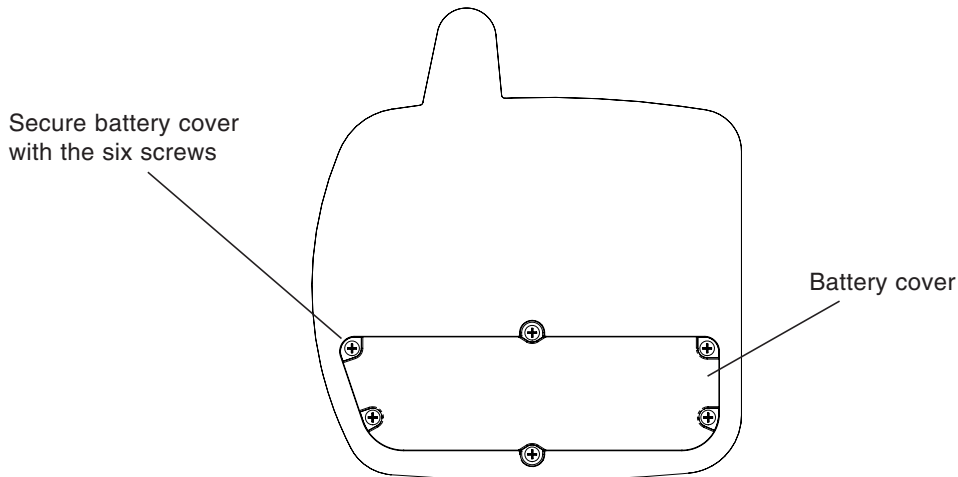

Easy Touch Control Panel (rear view)

4. **Power up the unit:** To switch the unit on, press the **Power On** button located on the front of the unit.
5. **Display messages after replacing batteries:** After replacing depleted batteries a check battery message is displayed on the screen. Press the **MENU** button to continue.
6. The screen will then display a second message to check the battery cover. After checking that the battery cover is secure and that all screws are tightened, press the **MENU** button.
The battery icon should display the fully charged icon (■). The unit is ready for use.

Setting up the EasyTouch wireless control panel for the first time

Setting up the EasyTouch wireless control panel

In order for the EasyTouch wireless control panel to communicate with the EasyTouch system outdoor control panel, the first time the wireless device is powered up it must first be assigned a unique communication address. For this process you need to access the menu for each control panel. For convenience it's easier to setup the wireless device at the outdoor control panel.

Note: Before you start verify that the transceiver antenna is connected to the EasyTouch load center. For installation instructions, refer to "EasyTouch Transceiver Installation," on page 51.

From the EasyTouch load center outdoor control panel

1. Switch power on to the EasyTouch load center.
2. Press **Menu** button, and select **Settings > Address** and press the **Right** arrow button.

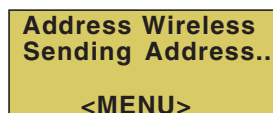
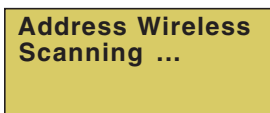

The EasyTouch outdoor control panel will display "Scanning..." for about five seconds while it searches for the EasyTouch wireless device within range of the transceiver antenna. After the scanning process has finished, "Sending Address" is displayed. The system is now waiting to lock on to the EasyTouch wireless control panel. Proceed to step 3.

From the EasyTouch wireless control panel

3. Press the **Power On** button located on the front of the wireless device.
Note: After replacing depleted batteries a check battery message is displayed on the screen. Press the **MENU** button twice to continue.
4. Press **Menu** button, and select **Settings > Address** and press the **Right** arrow button.
5. Select "Address" and press the **Right** arrow button to lock on to the unique address that is being transmitted from the outdoor control panel.

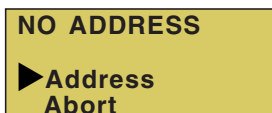

Note: If you choose "Abort," the device can continue to operate using the factory default address. If the outdoor control panel has been previously addressed, the wireless may not operate the system. Each time the device is switched on the "NO ADDRESS" will be displayed. This mode is not recommended for permanent use.

6. After selecting "Address" the wireless device unit will lock on to a unique address and display "Found ADDRESSED." Press the **Back** button to save and exit this mode. The device is ready for operation. If "Unit Mismatch" displays

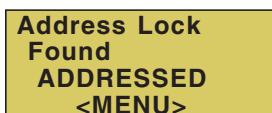

Note: "Unit Mismatch" displays if the outdoor control panel has an existing system image. See page 10 for details.



7. **On the outdoor control panel:** Press the outdoor control panel **Back** button three times to exit the "Sending Address" mode and return to the main screen. The system will continue to transmit an address until the Menu is button is pressed to stop the process.

Note: To re-address the EasyTouch wireless device, repeat steps 2 through 7 on the wireless device to restart the address process.

Synchronizing control panels

If the EasyTouch outdoor has been previously setup with specific pool and spa information and you install the EasyTouch wireless control panel with factory default information, the outdoor control panel will automatically download the existing system information to the wireless control panel. If the wireless control panel has a different firmware revision level than the outdoor control panel or it contains previous setup information, you can choose which system image to upload or download.

Synchronizing the control panels is initiated from the wireless control panel. The following describes how to synchronize the wireless control panel with the outdoor control panel.

Download from outdoor to wireless control panel

- Press the  Menu button to download the system image from the EasyTouch outdoor control panel to the wireless control panel.



Upload to outdoor from wireless control panel

1. Press the **Up/Down** button to access the “Upload” screen.
2. Press the  Menu button to upload the system image from the wireless control panel to the EasyTouch outdoor control panel.

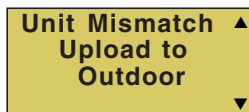

***Note:** To erase existing control panel system information, use the “Erase EEPROM” feature. Refer to “Erase EEPROM” on page 39 for more information.*

Quick start pool and spa operations

The following describes how to run some of the general day-to-day spa and pool operations.

Heat your spa or pool

AUTO	HEATER
SPA 95°F / 100°F	
AIR 70°F	
MON 09:30 AM	

First enable the heat source in the Heat menu (see “Heat Menu,” on page 18). Press the **Spa** button (top button) to switch the filter pump on, rotate the valve actuator (to isolate spa water from pool water), and switch the heater on. Note: By default, the setting “**Man Heat**” is set to “**On**” (see page 38) which allows the spa to begin to heat whenever it is manually turned on. Press the **Pool** button to switch the filter pump on, rotate the valve actuator (to isolate pool water from spa water), and switch the heater on. For Pool and Spa button location, see page 3.

Adjust your spa or pool heat settings

From the “Heat” menu (**Menu > Heat > Spa Temp/Src/Pool Temp/Src**) you can select the heat source and set the water temperature. The spa or pool water will heat to the settings specified. The EasyTouch system allows for solar and conventional heaters. The EasyTouch will use the heating source that is selected. The heat source selections are:

- **OFF** - No heating even though pump and other circuits may be operating.
- **HEATER** - Gas heater only.
- **SOLAR ONLY** - Solar heating system to be the only heat source. In order to display “Solar Only” as a heat option in the “Heat” menu, you must first enable solar in the **Settings > Solar** menu (see page 34).
- **SOLAR PREF. (Solar Preferred)** - Used if solar and gas heating are combined and you want to use solar heating only when it is most effective. In order to display “Solar Preferred” as a heat option in the “Heat” menu, you must first enable solar in the **Settings > Solar** menu (see page 34).

To set the spa temperature set point and select the heat source:



Pool Temp/Src ▲
▶ Spa Temp/Src ▼

Right button: Select spa temperature and heat source.

Up/Down button: Adjust the spa water temperature.
(from 40° F to 106° F or 4° C to 41° C).

Right or Left button: Move to Heat source options.

Up/Down: Set the Heat option: **Off, Heater, Solar, or Solar Preferred.**

Spa ▲
Temp: 85° F ▼
Heat: Off ▼

 Press the Back button save the settings and to return to the Heat menu or press the button again to return to the Main screen.

Note: Select “Pool Temp/Src” to adjust your pool temperature.

Switch on lights manually

From the Lights screen you can manually switch all lights on or off, and synchronize colored lights. Up to 12 lights can be controlled. For more information about setting up lights, refer to “Lights Menu” on page 19.

To manually switch on all lights:

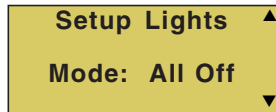

Up/Down button: Select: **All off**, **All on**, or **Sync**. The Sync feature allows a combination of up to 12 *SAm*, *SAL*, or *FIBERworks* lights to synchronize their colors before switching the lights on.

 Press the Back button save the settings and to return to the main menu items or press the button again to return to the Main screen.

Using the Once Only timer feature

The Schedules “Once Only” timer feature enables you to automatically switch equipment on for one time. This feature allows you to program a circuit to turn on at a particular time on a one-time basis. For example, if you wanted the spa to be heated when you arrive home, you could program the heater to switch on at a specific time and after you have finished using the spa you can switch the heater off manually. After the program has run, it is automatically erased. Unlike using the regular “Schedule” program, the “Once Only” program does not repeat. The circuit must be turned off manually or wait for the 12 hour automatic shut-off. However, you could also reset the 12 hour factory shut-off by entering an “Egg Timer” count down program to extend past the default 12 hours shut-off.

The following example describes how to set a “Once Only “ program for the spa. The same steps apply when selecting the pool or any auxiliary circuit.

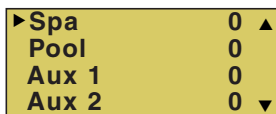
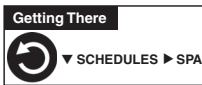

Right button: Select the **Spa** circuit. The generic circuit names are: Spa, Pool, Aux1-7 (EasyTouch 8), Aux 1-3 (EasyTouch 4), and Aux Extra “Aux Extra” is only available if the Solar output (J17) plug on the EasyTouch motherboard is not being used for solar equipment.

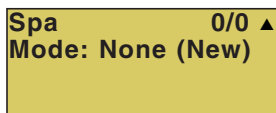

Right button: Select **Mode** if there are existing programs. Skip this step to create a new program.

Up/Down button: Select **New** to create a new program.

Right button: To create a new program and enter the “Mode” settings.

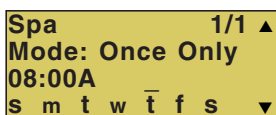

Up/Down button: 1/1 indicates that this circuit has one program. If there are existing programs assigned to this circuit, use these buttons to view and select the existing program settings.

Right button: To select the “Once Only” settings.

Right button: Move to start time settings.

Up/Down and Right buttons: Set the start hour (A/P) and minutes. A (AM) and P (PM) time is set when setting the start hour.

Right button: Move to day of the week to run the program.

Right button: Select which day to run the program then press the **Up/Down button** to enable the bar on top of the letter. A bar on top of the letter indicates the day selected to run the program.

 Press the Back button to save the settings and to return to the Schedules menu options. Press the button again to return to the main menu options or press again to return to the Main screen.

Schedule start and stop times for equipment

You can set timers (schedules) to automatically run equipment like pool filtration or lights. Any EasyTouch circuit can be set to switch on and off on every or any day of the week. Up to 12 total programs may be created for all circuits combined.

Program your Spa or Pool

You can use the “Schedule” feature to set the time and day(s) when to switch the filter pump on and rotate the pool/spa valves into the “Pool” or “Spa” position. The heater will automatically heat the pool or spa water up to the set point temperature as set in the “Heat” menu (see page 20). If the pool has a separate jet pump or blower controlled by AUX 1 and/or AUX 2 , these need to be scheduled separately.

Schedules

To create a schedule for your spa or pool:

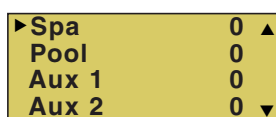

Right button: Select the **Spa** circuit. The generic circuit names are: Spa, Pool, Aux1-7 (EasyTouch 8), Aux 1-3 (EasyTouch 4), and Aux Extra “Aux Extra” is only available if the Solar output (J17) plug on the EasyTouch motherboard is not being used for solar equipment. Use the Down arrow button to switch the “extra” circuit on and off. Use the Down arrow button to switch the “extra” circuit on and off.

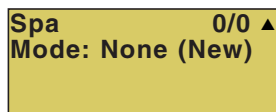

Right button: Select **Mode** if there are existing programs. Skip this step to create a new program.

Up/Down button: Select **New** to create a new program.

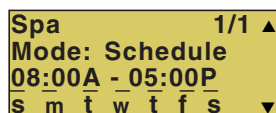

Right button: To create a new program and enter the “Mode” settings.

Up/Down button: 1/1 indicates that this circuit has one program. If there are existing programs assigned to this circuit, use these buttons to view and select the existing program settings.

Right button: To select the “Schedule” settings.

Right button: Move to start and stop time settings.

Up/Down and Right buttons: Set start and stop hour (A/P), minutes.

The A (AM) and P (PM) time is set when setting the start and stop hour.

Right button: Move to days of the week to run the program.

Right and Up/Down buttons: By default the program is set to run all the days of the week. If you wish to edit which days to run the program, select the day of the week, then press the **Up/Down** button to remove the bar from the top of the letter. A bar on top of the letter indicates the day selected to run the program.

 Press the Back button to save the settings and to return to the Schedules menu options. Press the button again to return to the main menu options or press again to return to the Main screen.

Setting the Egg Timer Feature

The “Egg Timer” feature lets you manually switch on equipment program the system to automatically switch off after a specified time. You can set this timer feature for other equipment such as lighting, spa, or spa jets. Equipment can be set to be on for one minute to 24 hours. An Egg Timer program is factory set to switch off after 12 hours. You also have the option to use the “Don’t Stop” feature to run a circuit continuously until manually switched off.

Please note that in the event of a power failure, the Egg Timer feature will not switch the circuit back on. Use the “Service” mode to turn the equipment back on. For more information, refer to the “EasyTouch User’s Guide (P/N 520584).

Note: When running the filter pump continuously during a new pool start up, it is recommended to use the “Service” mode, which will automatically restart the filter pump in the event of a power failure.

To set the Egg Timer feature:

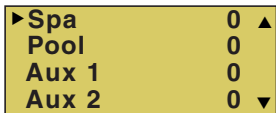
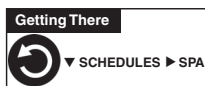

Right button: Select the **Spa** circuit. The generic circuit names are: Spa, Pool, Aux1-7 (EasyTouch 8), Aux 1-3 (EasyTouch 4), and Aux Extra “Aux Extra” is only available if the Solar output (J17) plug on the EasyTouch motherboard is not being used for solar equipment. Use the Down arrow button to switch the “extra” circuit on and off. Use the Down arrow button to switch the “extra” circuit on and off.

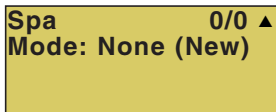

Right button: Select **Mode**.

Up/Down button: Select **New** to create a new program.

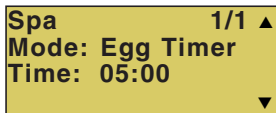

Right button: To create a new program and enter the “Mode” settings.

Up/Down button: 1/1 indicates that this circuit has one program. You create a total of 12 programs. If there are existing programs assigned to this circuit, use these buttons to view and select the existing program settings.

Right button: To select the “Egg Timer” settings.

Right button: Move to the time settings.

Up/Down and Right buttons: Set the hour and minutes for the program to run. The count down time can be set from 00:01 to 23:59 and Don’t Stop. The “Don’t Stop” feature allows the circuit to run continuously until manually switched off.

 Press the Back button to save the settings and to return to the Schedules menu options. Press the button again to return to the main menu options or press again to return to the Main screen.

Section 2

Setting up EasyTouch

Setting up the EasyTouch system for the first time

Use the following steps if you are setting up the EasyTouch system for the first time.

Note: The following setup steps assume that the EasyTouch Load Center is installed at the equipment pad and ready for operation. For EasyTouch Load Center installation instructions, refer to the EasyTouch 8 and 4 Load Center Installation Guide (P/N 520583).

The recommended first time installation steps for the EasyTouch system are:

1. Set the system date and time (page 26)

Use the “clock” menu option to set the current date and time for the EasyTouch system.

2. Assign circuit names (pages 29)

Assign the generic default circuit names for output auxiliary equipment. Rename (if necessary) and assign circuit names to the auxiliary (AUX 1, AUX 2) connections. Note the factory set auxiliary names correspond to the plug-in location of the relay on the EasyTouch motherboard. Assign circuit names from the available of circuit names. There are nearly 100 circuit names available (see page 30 for the complete list).

3. Creating custom names for auxiliary circuits (page 33)

If you cannot find a circuit name that fits your application you can create up to 10 additional customized names that can be created before assigning circuit names.

4. Assign a circuit type to a circuit name (Page 31)

Assign “Circuit Types” (functions) to circuits. From the Circuit Type menu, you can assign special logic to a circuit by selecting one of the available circuit types. For the complete list of Circuit Types. If an auxiliary circuit (AUX) is assigned GENERIC (simple ON/OFF when the button is pushed) then nothing needs to be done.

5. Configure valve actuators (controlled by AUX circuit) (page 33)

The EasyTouch system can drive two auxiliary valve actuators for applications such as solar heating and water features. Assign which circuits that will activate valves A and B. Auxiliary valve actuators can be controlled by any AUX circuit. Valve A is automatically assigned to solar if “Solar” is enabled in the “Solar” menu.

6. Set up optional equipment, solar, 2-speed pump (page 34)

Set up additional equipment such as solar, 2-speed pump, and optional equipment if required. Set up the control panel to operate with the optional IntelliChlor chlorine generator. To configure EasyTouch for special equipment:

- Is solar heating available? Is solar being used for a heat pump?
- What circuits will turn 2-Speed pumps to High Speed?
- Cool-down cycle for the heater - Lets you set circuits that switch the filter pump to high speed.
- Do you want to delay turning off the filter pump for 10 minutes when the heater is turned off?
- Do you want the spa to heat whenever the Spa button is pressed?

7. Configuring the heater system options (page 20)

Set the type of heat source being used (Heater, Solar, Solar Preferred).

8. Configure the iS4 spa-side remote, QuickTouch wireless remote buttons (page 36 and 37)

Assign four circuits to the iS4 and/or QuickTouch remote buttons. Once you have checked that all buttons operate properly, place labels on remote buttons.

9. Set the delays feature (page 35)

Enable the one time “delay” feature for the heater, 2-speed pump, and automatic pool cleaner.

10. Schedule on/off times for circuit (page 22 - 25)

Set times for automatic circuit activation. Up to 12 total programs can be created for all circuits combined. One circuit can have up to a maximum of 9 programs (9/9), which leaves 3 programs that can be used by one circuit or three separate circuits for a total of 12 programs. All user created programs are active all the time; so check that there are not conflicting automated times.

11. Setup the lighting settings (page 19)

From the lighting menu you can enable special control of your pool and yard lighting, such as rotating colored lights, and synchronized colored lights.

EasyTouch Menu Structure

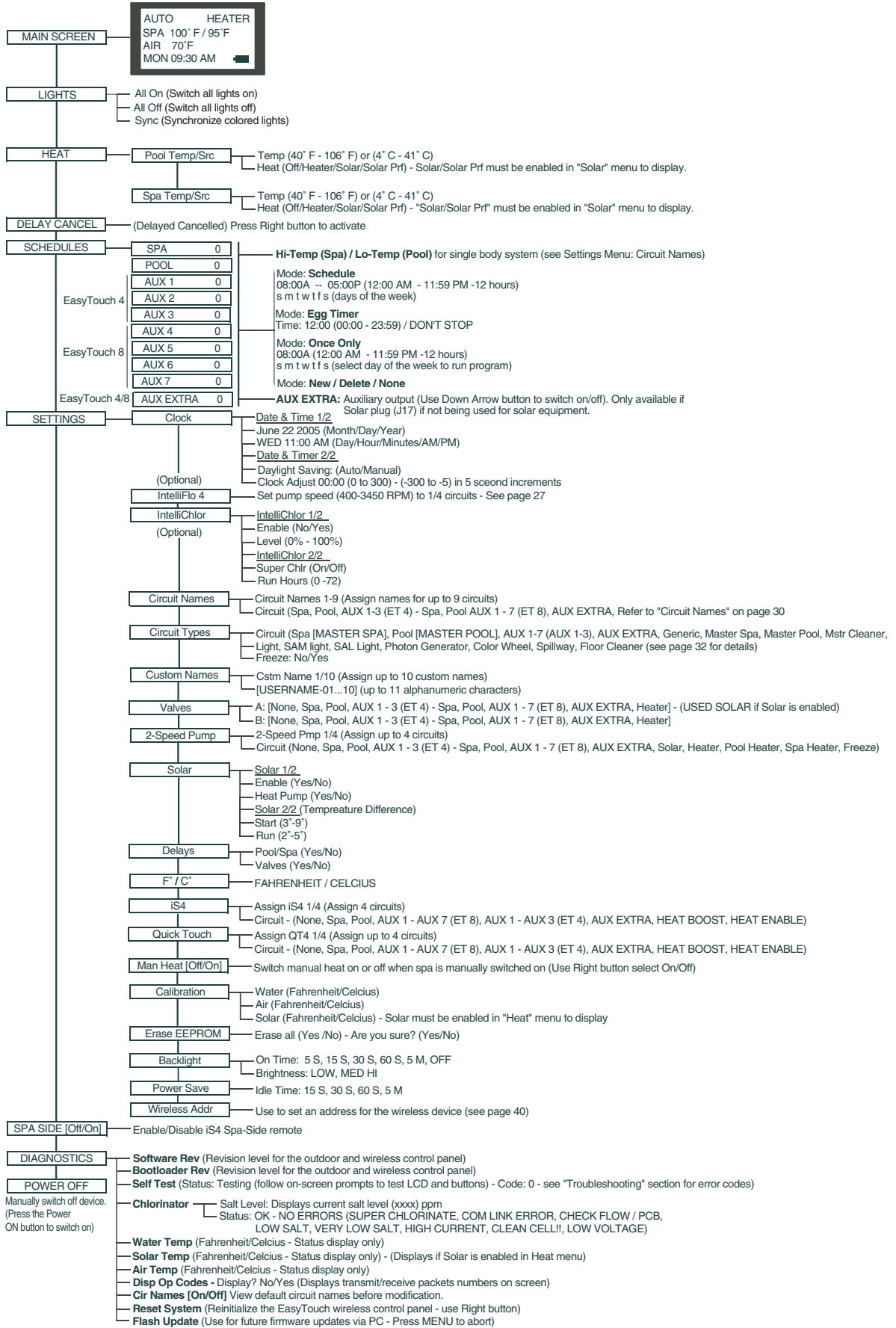



EasyTouch Menus

Use the EasyTouch control panel menus to schedule when to heat and filter your pool and spa automatically. Lights can also be switch on and off. The main screen shows the pool (or spa), temperatures and the system day and time. The main screen is automatically displayed if there is no menu control panel activity for five minutes.

The “Settings” and “Schedule” menus are typically used most often for daily spa and pool operations. The “Settings” menu is used by the pool installer to setup installed equipment which is connected to each output relay (filter pump, auxiliary relays, heater, valves, lights, etc.). For EasyTouch equipment installation instructions, see the EasyTouch Installation Guide (P/N 520584).

Main Screen

AUTO	HEATER
SPA	95°F / 100°F
AIR	70°F
MON 09:30 AM	

AUTO	
AIR	70°F
MON 09:30 AM	

The main screen shows the mode of operation (AUTO/SERVICE), the heat source being used. The spa (or pool) actual water temperature (95° F) and the current heater set point temperature (100° F) are displayed. The current air temperature is also displayed in either Fahrenheit or Celsius. If the second display line is blank and the heat source is not displayed, there is no spa or pool function currently active. If the IntelliChlor salt chlorine generator option is installed, pool and spa sanitizer settings, and salt level is shown in the Diagnostics, “Chlorinator” settings on page 42.

Main Screen Description

AUTO: EasyTouch is in normal (automatic) operating mode.

HEATER: The selected heat source as selected in the “Heat” menu (see page 20). The heat options are:

- **OFF** - No heating even though pump and other circuits may be operating.
- **HEATER** - Gas heater only.
- **SOLAR ONLY** - Solar heating system to be the only heat source. In order to display “Solar Pref.” on the main screen, you must first enable solar in the “Solar” menu (see page 34).
- **SOLAR PREF.** - (Solar Preferred) - For when solar and gas heating are combined, and you want to use solar heating only when it is most effective. In order to display “Solar Pref.” on the main screen, you must first enable solar in the “Solar” menu (see page 34).

SPA: “SPA” is displayed after the “Spa” button has been pressed to switch the filter pump on, rotate the valve actuator (to isolate spa water from pool water), and switch the heater on (if enabled in the “Heat” menu). The temperature unit displayed on the left side is the actual water temperature (95° F) and the set point temperature (100° F) as set in the “Heat” menu is displayed on the right side. Degree units are displayed in either Fahrenheit or Celsius (see page 36). If this display line is blank, it indicates no spa or pool function is currently active.

POOL: “POOL” is displayed after the “P” button has been pressed to switch the filter pump on, rotate the valve actuator (to isolate pool water from spa water), and switch the heater on (if enabled in the “Heat” menu). The temperature unit displayed on the left side is the actual water temperature (95° F) and the set point temperature (100° F) as set in the “Heat” menu is displayed on the right side. Degree units are displayed in either Fahrenheit or Celsius (see page 36). If this display line is blank, it indicates no spa or pool function is currently active.

AIR: Displays the actual outside air temperature (70° F) as recorded by the air sensor located near the EasyTouch load center. Degree units are displayed in either Fahrenheit or Celsius (see page 36).

DAY and TIME: The current system day and time (AM/PM). See the “Clock” menu to set the system day and time (page 26).

Lights Menu

From the Lights screen you can manually switch all lights on or off, and synchronize colored lights. If you have at least two Pentair *SAm* and/or *SAL*, and/or *FIBERworks* lighting systems you can use the Sync feature to change the lighting settings. This feature requires a separate auxiliary relay circuit for each light. Up to four lights can be assigned on each auxiliary circuit for a total of 12 lights that can be independently controlled from the Lights menu.

Make sure the AUX relay circuits which control your lighting have been assigned names. Then verify that *SAm* and/or *SAL*, and/or *FIBERworks* have been set up in “Circuit Types” as SAM or SAL lights. If *FIBERworks* lighting is incorporated, it also has to be set up as a “PHOTON GENERATOR” for the circuit controlling the light bulb, and COLOR WHEEL for the circuit controlling the color wheel. For more information about setting up lights, see “Settings Menu: Circuit Types,” on page 31.

Lights



To configure lights:

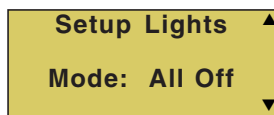

Up/Down button: Select: **All off**, **All on**, or **Sync**.

 Press the Back button save the settings and to return to the main menu items or press the button again to return to the Main screen.

The lights options are:

All Off: Switch all lights off manually.

All On: Switch all lights on manually.

Sync: Causes all colored lights to synchronize their colors.

Heat Menu

Use the heat menu settings to specify the set point temperature and select the heat source for the pool and spa water. The water will begin to heat whenever the heater is manually switched on, (by pressing the “Pool” or “Spa” button or the Valves (V) button outdoor control panel), even if the heater is set to off. The spa will also begin to heat when switched on by the optional iS4 Spa-Side remote, or EasyTouch wireless remote. The EasyTouch system allows for solar and conventional heaters. The EasyTouch will use the heating source that is selected. The heat source selections are:

- **OFF** - No heating even though pump and other circuits may be operating.
- **HEATER** - Gas heater only. Use the Heater button to automatically switch the heater on which controls the output between a “forced off” state and a normal, automatic thermostatic control operating state. The heater will continue heating the water until the heater’s current highest set point temperature triggers the heater sensor (approximately 106° F or 41° C). Note that the Heater button on the control panel does not activate the pump. Do not activate the heater without running the pump. The heater will not run if water flow is not detected.
- **SOLAR ONLY** - Solar heating system to be the only heat source. In order to display “Solar Pref.” on the main screen, you must first enable solar in the “Solar” menu (see page 34).
- **SOLAR PREF. (Solar Preferred)** - Solar and gas heating systems are installed, and you want to use solar heating only when it is most effective. In order to display “Solar Pref.” on the main screen, you must first enable solar in the “Solar” menu (see page 34). To set the spa temperature and select the heat source:

Pool Temp/Src



To set the pool temperature and select the heat source:

▶ Pool Temp/Src ▲ Spa Temp/Src ▼	Right button: Select pool temperature and heater options. Up/Down button: Set the pool temperature (from 40° F to 106° F). Right or Left button: Move to Heater option.
Pool ▲ Temp: 72° F Heat: Off ▼	Up/Down: Set Heater option: Off, Heater, Solar, or Solar Preferred.  Press the Back button save the settings and to return to the previous menu or press the button again to return to the Main screen.

Spa Temp/Src

To set the spa temperature and select the heat source:

▶ Pool Temp/Src ▲ Spa Temp/Src ▼	Right button: Select spa temperature and heater options. Up/Down button: Set the spa temperature (from 40° F to 106° F or 4° C to 41° C). Right or Left button: Move to Heater option.
Spa ▲ Temp: 85° F Heat: Off ▼	Up/Down: Set Heater option: Off, Heater, Solar, or Solar Preferred.  Press the Back button save the settings and to return to the Heat menu or press the button again to return to the Main screen.

Note: For an EasyTouch single body system, “Pool” and “Spa” modes are Lo-Temp (Pool) and Hi-Temp (Spa) temperature controls. For more information, see “Hi-Temp/Lo-Temp Controls for Single Body Systems,” on page 29.

Delay Cancel Menu

Use the Delay Cancel feature for service or testing purposes. For convenience, on a one-time basis, the Delay Cancel feature will cancel the following safety delays. Please note, generally there is no need to cancel any of the following delays except for servicing or testing the system.

- **Heater Cool-Down Delay Cancel:** Shuts Filter Pump off immediately.
- **2-Speed Filter Pump five-minute START on HIGH SPEED Delay Cancel:** Shifts pump to low speed.
- **Automatic Pool Cleaner START Delay:** Starts Cleaner Pump immediately, without normal delay in which the filter pump first runs for 5 minutes.
- **Automatic Pool Cleaner SOLAR Delay:** Allows Cleaner Pump to run even though solar delay has shut it off for 5 minutes.

Some heaters require a cool-down cycle before being switched off. This can be setup in the menu to run the filter pump an additional ten minutes to dissipate residual heat built up inside the heater combustion chamber. The Delay Cancel feature is mainly for use by service technicians when it's necessary to shut the filter pump off immediately, and know the heater has not been running. Heaters manufactured by Pentair do not require this cool-down period and do not need the delay to be set up.

Note: For Information about assigning delays to the pool and spa valves, refer to “Settings Menu: Delays” on page 35.



Delay Cancel

To activate Delay Cancel:

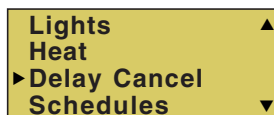

Up/Down button: Select Delay Cancel.

Right button: Use this button activate Delay Cancel for one time only. “Delay Cancelled” is displayed after pressing the Right button.



Press the Back button to return to the Main screen.

Schedules Menu

Use the “Schedules” menu to create programs that automatically run equipment like pool filtration or lights. Any circuit can be programmed to switch on and off at a specific time on every or any specific day of the week. The number of programs that can be created for circuits are as follows:

- Up to 12 total programs can be created for all circuits combined.
- One circuit can have up to a maximum of 9 programs (9/9), which leaves 3 programs that can be used by one circuit or three separate circuits for a total of 12 programs.

Using the Schedules menu

Use the “Schedules” menu to program operating schedules for the pool, spa and auxiliary circuits:

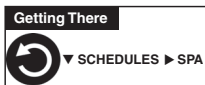

Spa	0	▲
Pool	0	
Aux 1	0	
Aux 2	0	▼

Choose the circuit to program

Up/Down button: Select the generic circuit name to program: Spa, Pool, Aux 1-8 (EasyTouch 8), Aux 1-4 (EasyTouch 4) and Aux Extra. “Aux Extra” is only available if the Solar output is not being used (see page 4).

The current number of programs for each circuit is displayed opposite the circuit name. A circuit can have up to 9 programs (9/9). Three additional programs can be assigned to another circuit or three separate circuits for a maximum of 12 programs.

Spa	0/0	▲
Mode: None		

Create a new program

The current number of programs for each circuit is indicated opposite to the circuit name. 0/0 indicates no programs assigned to this circuit.

Right button: To move to the “Mode” selection.

Spa	0/0	▲
Mode: New		
		▼

Up/Down button: Select **New** to create a new program. Use “None” when a circuit has existing programs and you wish to exit the “Mode” selections without modifying the existing programs.

Spa	1/1	▲
Mode: Schedule		
08:00A - 05:00P		
s m t w t f s		▼

Choose the type (Mode) of program to run

After selecting “New” the current program number (1/1) for this circuit is displayed.

Right button: To move to the “Mode” selections.

Spa	1/1	▲
Mode: Egg Timer		
Timer: 12:00		
		▼

Up/Down button: Choose the program to run: **Schedule, Egg Timer, Once Only, New, Delete, and None**. If there are existing programs assigned to this circuit, use these buttons to view and select the existing program settings.

Mode Selection:

Spa	1/1	▲
Mode: Once Only		
08:00A		
s m t w t f s		▼

Schedule: Set start, stop times and the day(s) of the week to automatically switch pool/spa circuits on or off. Default run time for the “Schedule” feature is 8:00 AM to 5:00 PM. If you program the start and stop times the same the schedule is will run for 24 hours.

Spa	1/1	▲
Mode: New		
		▼

Egg Timer: A one time program that switches on a function at a specific time, and counts down the pre-set time to the switch off the function. After the “Egg Timer” schedule has finished, the system can be operated in manual mode. The “DON'T STOP” option allows a circuit to run continuously until its switched off manually.

Spa	1/1	▲
Mode: Delete		
		▼

Once Only: Schedule a circuit to switch on at a particular time on a one-time basis.

Spa	1/1	▲
Mode: None		
		▼

New: press the **Right** button to create a new program.

Delete: Select the program and press the **Right** button to delete it.

None: Press the **Right** button to exit the “Mode” selections without modifying the program.

Schedules Menu (Continued)

Program your Spa or Pool

You can use the “Schedule” feature to set the time and day(s) when to switch the filter pump on and rotate the pool or spa valves into the “Spa” or “Pool” position. The heater will automatically heat the spa or pool water up to the set point temperature as set in the “Heat” menu (see page 20). If the pool has a separate jet pump or blower controlled by AUX 1 and/or AUX 2 , these need to be scheduled separately.

Schedules

You can create schedules to automatically run equipment like pool filtration or lights. Any circuit can be set to switch on and off on every or any specific day of the week. When a relay is switched on manually, it remains on until you either switch it off manually, or the next time the relay is scheduled to be switched off. For example, if the filter pump is scheduled to automatically run from 3:00 PM to 5:00 PM daily then the filter pump is switched on manually at 9:00 PM, it will run continuously for 12 hours until the next day at 6:00 PM then switch off. The programmed schedule will then continue from then on. Default run time for the “Schedule” feature is 12 hours. If you program the start and stop times the same the schedule will run for 24 hours if scheduled to run for one day. A pool or spa program can be overridden using the Filter (F) button and pool/spa Valves (V) button on the outdoor control panel in the EasyTouch load center. The system must be in “Service” manual mode to operate these buttons.

Note: The following example describes how to use the “Schedule” feature to program the spa circuit to switch the filter pump on and rotate the valves into the “Spa” position and switch the heater on. This example can also be used to program when to filter and heat your pool, and switch light or auxiliary circuits on or off.

To create a schedule for your spa:

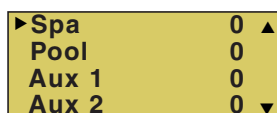

Right button: Select the **Spa** circuit. The generic circuit names are: Spa, Pool, Aux 1-7 (EasyTouch 8), Aux 1-3 (EasyTouch 4), and Aux Extra “Aux Extra” is only available if the Solar output (J17) plug on the EasyTouch motherboard is not being used for solar equipment.

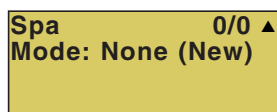

Right button: Select **Mode** if there are existing programs. Skip this step to create a new program.

Up/Down button: Select **New** to create a new program.

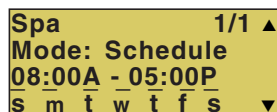

Right button: To create a new program and enter the “Mode” settings.

Up/Down button: 1/1 indicates that this circuit has one program. If there are existing programs assigned to this circuit, use these buttons to view and select the existing program settings.

Right button: To select the “Schedule” settings.

Right button: Move to start and stop time settings.

Up/Down and Right buttons: Set start and stop hour (A/P), minutes.

The A (AM) and P (PM) time is set when setting the start and stop hour.

Right button: Move to days of the week to run the program.

Right and Up/Down buttons: By default the program is set to run all the days of the week. If you wish to edit which days to run the program, select the day of the week, then press the **Up/Down** button to remove the bar from the top of the letter. A bar on top of the letter indicates the day selected to run the program.

 Press the Back button to save the settings and to return to the Schedules menu options. Press the button again to return to the main menu options or press again to return to the Main screen.

Using the Once Only feature

The “Once Only” feature allows you to program a circuit to switch on at a particular time and day on a one-time basis. A typical use for this feature is to have the spa and heater switch on before you get home from work for one evening. Unlike the regular “Schedule” timer, this feature does not repeat. After this event has finished, the program is automatically erased. The circuit must be switched off manually or wait for the 12 hour automatic shut off. If you wish to override the 12 hour default shut-off time you can extend the time by using the “Egg Timer” count-down feature (page 25).

Note: The following example describes how use the “Once Only” feature to program the spa circuit to switch the filter pump on and rotate the valves into the “Spa” position and switch the heater on for one time only. This example can also be used if you wanted to program when to filter and heat your pool, and switch light or auxiliary circuits on.

The set a “Once Only Timer” program for the spa.

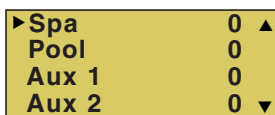

Right button: Select the **Spa** circuit. The generic circuit names are: Spa, Pool, Aux1-7 (EasyTouch 8), Aux 1-3 (EasyTouch 4), and Aux Extra “Aux Extra” is only available if the Solar output (J17) plug on the EasyTouch motherboard is not being used for solar equipment. Use the Down arrow button to switch the “extra” circuit on and off. Use the Down arrow button to switch the “extra” circuit on and off.

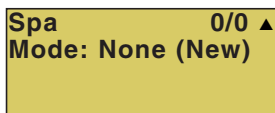

Right button: Select **Mode** if there are existing programs. Skip this step to create a new program.

Up/Down button: Select **New** to create a new program.

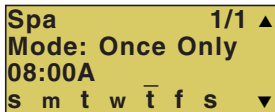

Right button: To create a new program and enter the “Mode” settings.

Up/Down button: 1/1 indicates that this circuit has one program. If there are existing programs assigned to this circuit, use these buttons to view and select the existing program settings.

Right button: To select the “Once Only” settings.

Right button: Move to start time settings.

Up/Down and Right buttons: Set the start hour (A/P) and minutes. A (AM) and P (PM) time is set when setting the start hour. Note: if the Start Time is set to an hour which has already passed, then the program will be executed the following day.

Another day of the week may also be chosen. The stop time will be 12 hours later, or can be turned off manually. The 12-hour shut off can be changed to any length of time by entering another program using the “Egg Timer” program (page 25).

Right button: Move to day of the week to run the program.

Right button: Select which day to run the program then press the **Up/Down button** to enable the bar on top of the letter. A bar on top of the letter indicates the day selected to run the program.

 Press the Back button to save the settings and to return to the Schedules menu options. Press the button again to return to the main menu options or press again to return to the Main screen.

Using the Egg Timer (count-down) Feature

The “Egg Timer” feature allows you switch off a circuit automatically after a specified time. The time period can be anywhere from one minute to 24 hours or run continuously. The “Egg Timer” (count-down) feature is useful for switching off lighting and spa therapy jets. For example, a jet pump can be set to switch off in 15 minutes, even when switched on by the iS4 Spa-Side remote control or whenever you switch your spa on, you would like it to automatically switch it off in two hours. All Egg Timer programs are factory set to switch off after 12 hours. You also have the option to use the “Don’t Stop” feature to run a circuit continuously until manually switched off.

Please note that in the event of a power failure, the “Egg Timer” feature will not switch the circuit back on. Use the “Service” mode to turn the equipment back on. For running the filter pump continuously during new pool start up, it is recommended to use the “Service” mode, which will automatically restart the filter pump in the event of a power failure.

The following example describes how to program the “Egg Timer” for the spa. The same applies when selecting the pool or any auxiliary circuit.

To set the Egg Timer feature:

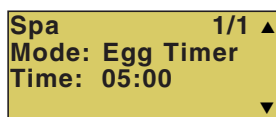
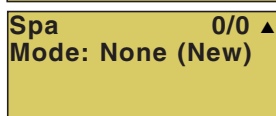
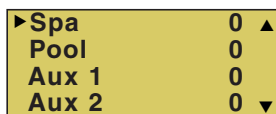
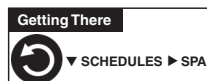

Right button: Select the **Spa** circuit. The generic circuit names are: Spa, Pool, Aux1-7 (EasyTouch 8), Aux 1-3 (EasyTouch 4), and Aux Extra “Aux Extra” is only available if the Solar output (J17) plug on the EasyTouch motherboard is not being used for solar equipment. Use the Down arrow button to switch the “extra” circuit on and off. Use the Down arrow button to switch the “extra” circuit on and off.

Right button: Select **Mode** if there are existing programs. Skip this step to create a new program.

Up/Down button: Select **New** to create a new program.

Right button: To create a new program and enter the “Mode” settings.

Up/Down button: 1/1 indicates that this circuit has one program. If there are existing programs assigned to this circuit, use these buttons to view and select the existing program settings.

Right button: To select the “Egg Timer” settings.

Right button: Move to the time settings.

Up/Down and Right buttons: Set the hour and minutes for the program to run. The count down time can be set from 00:01 to 23:59 and Don’t Stop. The “Don’t Stop” feature allows the circuit to run continuously until manually switched off.

 Press the Back button to save the settings and to return to the Schedules menu options. Press the button again to return to the main menu options or press again to return to the Main screen.

Settings Menu: Clock

Use the “Clock” menu to set the EasyTouch system date and time. The day, time and AM/PM is displayed on the main screen. The system clock settings are used for the EasyTouch system scheduled operations. The EasyTouch system clock will continue to run even if power is removed from the EasyTouch system at the load center.



Clock

To set the system date and time:

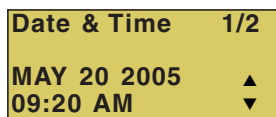

Right button: Move to the day setting.

Up/Down buttons: Set the day of the month.

Right button: Move to the year setting.

Up/Down buttons: Set the year.

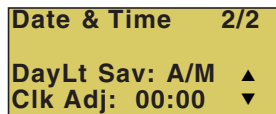

Right button: Move to the next page settings (2/2).

Up/Down buttons: Set Daylight Savings to Auto or Manual. Auto keep track of the semi annual time changes. If you do not live in an area that observes daylight savings time, choose Manual.

Right button: Move to the clock adjustment setting. If the internal system clock loses time during the month, use this setting to set the number of seconds in five second increments per month to automatically adjust the clock to the correct time.

Up/Down buttons: Adjust the offset in five second increments.

 Press the Back button to save the settings and to return to the Settings menu options. Press the button again to return to the main menu options or press again to return to the Main screen.

Settings Menu: IntelliFlo 4

IntelliFlo 4 Variable Speed Pump

This feature allows you to assign a circuit to control the IntelliFlo 4 pump speed. The pump speed can be adjusted to run from 400 to 3450 RPM in increments of 10 RPM. For more information about the IntelliFlo pump, refer to the IntelliFlo 4 Installation and User's Guide (P/N 357269).

IntelliFlo 4

To adjust the speed of the IntelliFlo 4 pump:

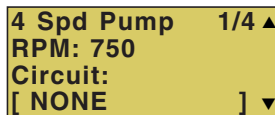

Up/Down buttons: Select the circuit number 1 of 4 (1/4). The default speed for each circuit correspond to the four speed buttons on the IntelliFlo control panel. The preset speed for each button is: Speed 1 button 750 RPM, Speed 2 button 1500 RPM, Speed 3 button 2350 RPM, and Speed 4 button 3110 RPM.

Right button: Move to RPM to change the pump speed.

Up/Down buttons: Set speed of the pump from 400 to 3450 RPM in increments of 10 RPM.

Right button: Move to the circuit names.

Up/Down buttons: Assign the circuit: None, Spa, Pool, Aux 1-7 (EasyTouch 8), Aux 1-3 (EasyTouch 4), Aux Extra (only if Solar is not selected, see page 35), Heater, Pool Heater, Spa Heater, Freeze, and Hi-Speed. "Aux Extra" is only available if the Solar output (J17) plug on the EasyTouch motherboard is not being used for solar equipment. Use the Down arrow button to switch the "extra" circuit on and off.

Right button: Press the Up arrow button and go to the next circuit page settings (2/4) and repeat the previous steps.

 When finished setting up the circuits, press the Back button to save the settings and to return to the Settings menu options. Press the button two times to return to the main screen.

IntelliFlo 4 external control

EasyTouch communicates with the IntelliFlo 4 pump via a two-wire RS-485 cable. For information about connecting the RS-485 communication cable from EasyTouch to the IntelliFlo pump, refer to the IntelliFlo 4 Installation and User's Guide (P/N 357269).

Settings Menu: IntelliChlor

The IntelliChlor electronic chlorination system must be connected to the EasyTouch system to use the following IntelliChlor settings. While in normal operating mode (“Pool,” “Spa” mode or “Spa Fill (Spillway),” EasyTouch will control the chlorinator output level. When IntelliChlor is connected to the EasyTouch outdoor control panel, chlorination levels can only be changed from the EasyTouch outdoor control panel, indoor control panel or wireless control panel. The amount of chlorine introduced into the pool is determined by the amount of salt in the water, water temperature, and the amount of time the pool operates in “Pool” mode. Note: While in “Freeze Protection” mode, IntelliChlor will not operate during the time that the filter pump is operating. For more information, refer to the IntelliChlor Electronic Chlorine Generator User’s Guide (P/N 520589).

IntelliChlor

To setup the IntelliChlor system:

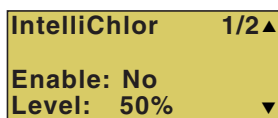

Right button: Move to Enable/Disable settings. (To select the second page settings, press the **Up/Down** button to change the first digit to 2/2).

Up/Down buttons: Select **Yes** or **No** to enable or disable the IntelliChlor system.

Right button: Move to the “Level” settings.

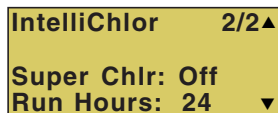

Up/Down buttons: Set the chlorination output level for the pool/spa water from 0 to 100%. EasyTouch will determine the chlorinator output level when the system is operating in “Spa” or “Pool” mode. The amount of chlorine introduced into the pool/spa is determined by the amount of salt in the water, water temperature, and the amount of time the pool/spa operates in these modes mode.

Right button: Move to the next page settings (2/2).

Up/Down buttons: Select 2/2.

Right button: Move the Super Chlorination settings.

Up/Down buttons: Set Super Chlorination **On** or **Off**. See note below about Super Chlorination.

Right button: Move to “Run Hours” setting.

Up/Down buttons: Set the number of hours to run Super Chlorination. 24 hours is the default setting. Run hours can be set from 0 to 72 hours.

 Press the Back button to save the settings and to return to the Settings menu options. Press the button again to return to the main menu options or press again to return to the Main screen.

Note: For IntelliChlor status messages, see “Diagnostics: Chlorinator” on page 42.

About Super Chlorination: The Super Chlorination feature is used to introduce large amounts of chlorine into the pool water if there has been heavy rain fall, many bathers in the pool, cloudy water conditions, etc. When Super Chlorination is enabled, the system will switch on the filter pump, set the pool/spa valves to the correct position, and set the IntelliChlor chlorine generator to maximum output. This process continues for 24 hours. At the end of the Super Chlorination process, the pool will return to normal operation. It is possible to manually stop the Super Chlorination process and switch off the filter pump using the Filter (F) button on the control panel. When the filter pump is switched on again using the Filter (F) button, the Super Chlorine process will resume for the duration of time left.

Settings Menu: Circuit Names

Labeling Circuit Buttons on the Wireless Control Panel

EasyTouch is shipped from the factory with each output circuit identified with its generic name (e.g. AUX 1, AUX 2, etc.). These generic circuit auxiliary names can be assigned a new names which are more descriptive of the equipment being controlled. This makes it much easier to operate all of the equipment on your pool without having to memorize what each output controls.

Circuit name labels are also provided to be placed on top of each auxiliary control panel button. Use the written list of circuit names (buttons) you made while setting up the EasyTouch load center. Identify what you labeled circuit button 1, button 2 etc. The circuit names you assign should match the labels you put next to the control panel buttons and the outdoor control panel buttons. Note that examples shown below use the factory set generic output names. Note that examples shown use the factory set generic output names (AUX 1), for your system you should change these generic names.

Circuit Names

To assign circuit names:

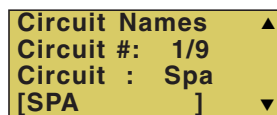

Up/Down buttons: Select the circuit number 1 of 10 (1/10). The generic circuits names are: Spa, Pool, Aux 1-7 (EasyTouch 8), Aux 1-3 (EasyTouch 4), Auxx (Aux Extra). The circuit number (1/10) corresponds to its assigned circuit name. This name can be changed to suite the function. “Aux Extra” is only available if the Solar output (J17) plug on the EasyTouch motherboard is not being used for solar equipment. Use the Down arrow button to switch the “extra” circuit on and off. Use the Down arrow button to switch the “extra” circuit on and off.

Right button: Move to EasyTouch preset circuit names and user defined custom circuit names.

Up/Down buttons: Scroll through the list of alphabetical programmed names. If you cannot find a name to match your circuit, you can create your own custom name (see page 30). Repeat for all the circuit buttons that you wish to assign names to. For a complete list of EasyTouch circuit names, see page 30.

 Press the Back button to save the settings and to return to the Settings menu options. Press the button again to return to the main menu options or press again to return to the Main screen.

Note: After a generic circuit name is changed and saved, the new name is displayed in the menu settings. You can view the default generic circuit names in the menu settings before they were changed by enabling “Cir Names.” Refer to “Diagnostics: Cir Names (Off),” on page 43.

Hi-Temp/Lo-Temp Controls for Single Body System

For an EasyTouch single body system, you have the option to control your pool and spa temperature settings using the Spa (Hi-Temp) and Pool (Lo-Temp) button on the Wireless control panel. Change the circuit name **SPA** to **HI-TEMP** and **POOL** to **LO-TEMP** so that the display shows the correct temperature controls for your single body system.

EasyTouch Circuit Names

AERATOR	NOT USED	Custom Circuit Names (11 characters maximum)	
AIR BLOWER	OZONATOR	USERNAME-01	_____
AUX 1	PATH LIGHTS	USERNAME-02	_____
AUX 2	PATIO LTS	USERNAME-03	_____
AUX 3	PERIMETER L	USERNAME-04	_____
AUX 4	PG2000	USERNAME-05	_____
AUX 5	POND LIGHT	USERNAME-06	_____
AUX 6	POOL PUMP	USERNAME-07	_____
AUX 7	POOL	USERNAME-08	_____
AUX 8	POOL HIGH	USERNAME-09	_____
AUX 9	POOL LIGHT	USERNAME-10	_____
AUX 10	POOL LOW		
AUX EXTRA	POOL SAM		
BACKWASH	POOL SAM 1		
BACK LIGHT	POOL SAM 2		
BBQ LIGHT	POOL SAM 3		
BEACH LIGHT	SECURITY LT		
BOOSTER PUMP	SLIDE		
BUG LIGHT	SOLAR		
CABANA LTS	SPA		
CHEM. FEEDER	SPA HIGH		
CHLORINATOR	SPA LIGHT		
CLEANER	SPA LOW		
COLORWHEEL	SPA SAL		
DECK LIGHT	SPA SAM		
DRAIN LINE	SPA WTRFLL		
DRIVE LIGHT	SPILLWAY		
EDGE PUMP	SPRINKLERS		
ENTRY LIGHT	STREAM		
FAN	STATUE LT		
FIBER OPTIC	SWIM JETS		
FIBERWORKS	WTR FEATURE		
FILL LINE	WTR FEAT LT		
FLOOR CLNR	WATERFALL		
FOGGER	WATERFALL 1		
FOUNTAIN	WATERFALL 2		
FOUNTAIN 1	WATERFALL 3		
FOUNTAIN 2	WHIRLPOOL		
FOUNTAIN 3	WTRFL LGHT		
FOUNTAINS	YARD LIGHT		
FRONT LIGHT			
GARDEN LTS			
GAZEBO LTS			
HIGH SPEED			
HI-TEMP			
HOUSE LIGHT			
JETS			
LIGHTS			
LOW SPEED			
LO-TEMP			
MALIBU LTS			
MIST			
MUSIC			

Settings Menu: Circuit Types

Assigning Circuit Types

From the “Circuit Types” menu you can assign special logic to the circuits. For example, when setting up an automatic pool cleaner pump, you would assign the circuit type MASTER CLEANER. With this “Cleaner” logic the cleaner pump would force the filter pump on, and the cleaner pump would start after a delay of five minutes. The cleaner pump would automatically shut off whenever the spa and/or solar is switched on.

Freeze Protection

Freeze protection switches on a circuit if the outside air temperature sensor detects the temperature is getting close to freezing (below 35° F). The system will switch on all circuits that have been assigned freeze protection, and runs the circuits for 15 minutes to stop the pipes from freezing. This is especially important if there is a pool and spa combination. If freeze protection is set to both the spa and pool circuits, the filter pump switches on and the pool and spa valves alternate every 15 minutes to keep the water moving in both the pool and spa. This process continues until the freeze condition is over.

Circuit Types

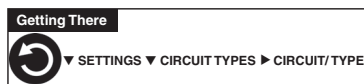

To assign a circuit type and freeze protection:

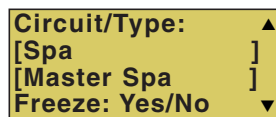

Up/Down buttons: Choose the circuit and assign it a function. The generic circuits names are: Spa [Master Spa], Pool [Master Pool], Aux 1-7 (EasyTouch 8), Aux 1-3 (EasyTouch 4), and Aux Extra. “Aux Extra” is only available if the Solar output (J17) plug on the EasyTouch motherboard is not being used for solar equipment. Use the **Down arrow** button to switch the “extra” auxiliary circuit on and off.

Right button: Move to circuit type setting to select the type of logic needed for your circuit.

Up/Down buttons: Set the type of circuit to use. This is the circuit that you wish to assign the function logic to. For a complete list of preset circuit types, see “Preset Circuit Types,” on page 32.

Right button: Move to Freeze Protection setting.

Up/Down buttons: Select **Yes** or **No** to assign freeze protection to this circuit. If “Yes” is selected, the circuit will switch on if the air temperature drops to 35° F.

Note: for the POOL circuit the filter pump will have freeze protection. For the SPA circuit the filter pump will run and the pool/spa valves will switch between pool and spa at 15 minutes intervals throughout the freeze condition. For the MASTER CLEANER circuit freeze protection is generally not needed for pool cleaner pumps since they get water flow from the filter pump. Just make sure that POOL has freeze protection.

 Press the Back button to save the settings and to return to the Settings menu options. Press the button again to return to the main menu options or press again to return to the Main screen.

Preset Circuit Types

Generic	No special Logic. Simple On/Off control of a circuit with all the programmable capabilities.
Master Spa	Works with automatic pool cleaner pumps or cleaner valve actuator. It does the following: <ul style="list-style-type: none"> - Forces the filter pump on 5 minutes before the cleaner pump switches on. - Switch the cleaner off when the spa is on. - Switch the cleaner off for 5 minutes when the solar heating begins.
Master Pool	Works with automatic pool cleaner pumps or cleaner valve actuator. It does the following: <ul style="list-style-type: none"> - Forces the filter pump on 5 minutes before the cleaner pump switches on. - Switch the cleaner off when the spa is on. - Switch the cleaner off for 5 minutes when the solar heating begins.
Master Cleaner	Works with automatic pool cleaner pumps or cleaner valve actuator. It does the following: <ul style="list-style-type: none"> - Forces the filter pump on 5 minutes before the cleaner pump switches on. - Switch the cleaner off when the spa is on. - Switch the cleaner off for 5 minutes when the solar heating begins.
Light	Allows special lighting features to work, such as ALL lights on or ALL lights off.
SAM Light	Activates special color lighting programs on other screens on the Indoor Control Panel when used with SAM pool lights. For example, you can have ALL lights on or ALL lights off.
SAL Light	Activates special color lighting programs on other screens on the Indoor Control Panel when used with SAL spa lights. For example, you can have ALL lights on or ALL lights off.
Photon Generator	Lets Pentair Fiberworks fiber optic bulb be operated by Lights menu features Sync, Rotate, ALL ON and ALL OFF when used with SAM and SAL lighting.
Color Wheel	Activates special color lighting programs on other screens on the Indoor Control Panel when used with Pentair Fiberworks. For example, you can have ALL lights on or ALL lights off.
Spillway	For pool/spa combinations where the spa is raised above the pool. This setting moves the return valve so that the filter pump pulls the water from the pool and returns it to the spa, creating a water fall effect. Automatic pool cleaners are turned off when this feature is turned on.
Floor Cleaner	This setting moves a 3-way valve every 20 minutes alternating flow between 2 cleaner system valves that feed the pop-up heads.

Settings Menu: Custom Names

There are nearly 100 circuit names available to choose from. If you cannot find one to fit your application you can create up to 10 custom names. Each name can be up to 11 alphanumeric characters. After a custom name is saved, it is then available for selection in the Schedules, 2-Speed Pump, iS4 and QuickTouch menus.

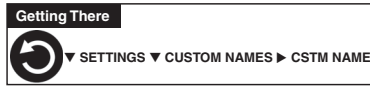

Custom Name

To assign a custom circuit name:

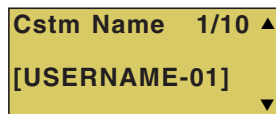

Up/Down buttons: Select a custom circuit name number (1-10). You can create up to 10 custom circuit names.

Right button: Move to custom circuit name setting.

Up/Down/Right buttons: Enter the custom circuit name (11 characters maximum).

 Press the Back button to save the settings and to return to the Settings menu options. Press the button again to return to the main menu options or press again to return to the Main screen.

Settings Menu: Valves

This feature lets you assign a circuit to Valve A or B. The EasyTouch system can drive two auxiliary valve actuators (A and B) for applications such as solar heating and water features. By assigning AUX circuits to control valve actuators, you can conserve auxiliary circuits for high voltage relays for controlling pumps and lights.

Valve A: Resides on the motherboard. If solar heating is setup and is not configured as a heat pump, then this Valve A is dedicated for controlling the solar heating valve actuator.

Valve B: Resides on the motherboard. Can be configured to be controlled by any circuit.



Valves

To assign a circuit to Valve A and Valve B:

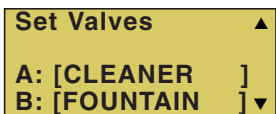

Up/Down buttons: Select a circuit to assign to Valve A. The generic circuit selections are: The generic circuits names are: None, Spa, Pool, Aux 1-7 (EasyTouch 8), Aux 1-3 (EasyTouch 4), Aux Extra and Heater. “Aux Extra” is only available if the Solar output (J17) plug on the EasyTouch motherboard is not being used for solar equipment. Use the **Down arrow** button to switch the “extra” auxiliary circuit on and off.

Right button: Move to Valve B setting.

Up/Down buttons: Select a circuit to assign to Valve B. The generic circuits names are: None, Spa, Pool, Aux 1-7 (EasyTouch 8), Aux 1-3 (EasyTouch 4), Aux Extra and Heater. “Aux Extra” is only available if the Solar output (J17) plug on the EasyTouch motherboard is not being used for solar equipment.

 Press the Back button to save the settings and to return to the Settings menu options. Press the button again to return to the main menu options or press again to return to the Main screen.

Settings Menu: 2-Speed Pump

Equipment circuits selected in this menu will automatically switch a two-speed filter pump to high speed when these circuits are on. If a two-speed pump is assigned to solar, a cleaner or a pump, when activated the pump will automatically run for five minutes in high speed then switch to low speed. For example, when on, the filter pump will switch to high speed whenever the JETS or CLEANER is on. There must be a two-speed relay installed in the EasyTouch Load Center in order for the “2-Speed Pump” menu settings to function.

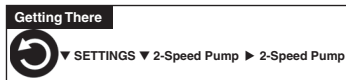

2-Speed Pump

To configure a two-speed pump to a circuit:

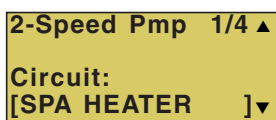

Up/Down buttons: Select a circuit that will switch the filter pump to high speed. You can set up to four circuits to use a two-speed pump (1/4, 2/4, 3/4, 4/4).

Right button: Move to assign a circuit setting.

Up/Down buttons: Select the circuit to assign to a two-speed pump. The generic circuits names are: None, Spa, Pool, Aux 1- 7 (EasyTouch 8), Aux 1- 3 (EasyTouch 4), Aux Extra, Heater, Pool Heater, Spa Heater and Freeze. “Aux Extra” is only available if the Solar output (J17) plug on the EasyTouch motherboard is not being used for solar equipment.

Right button: Assign the next circuit (2/4).

Up/Down buttons: Select the first digit for the circuit number (1/4, 2/4, 3/4, 4/4).

Right button: Move to circuit setting.

Up/Down buttons: Select the next circuit. When finished press the **Menu** button.

 Press the Back button to save the settings and to return to the Settings menu options. Press the button again to return to the main menu options or press again to return to the Main screen.

Settings Menu: Solar

Use the solar settings to setup solar or configure solar as a heat pump:

Setting Up Solar Control: Ensure that the solar temperature sensor is installed.

About Installing Solar Heating: First, install the solar sensor at the collectors and connect to the EasyTouch load center. If “HEAT PUMP” is selected and is being used in place of a solar heating system, install Solar sensor near the EasyTouch Load Center. Connect the wires to the SOLAR screw terminals. Plug the solar valve actuator cable into three-pin socket marked VLV A on the EasyTouch motherboard. If a solar booster pump is being installed, connect the pump to a power relay and plug a low voltage cable from relay into the two-pin socket marked SOLAR on the EasyTouch motherboard.

*Note: If Solar is not selected (No), the EasyTouch menu selections display “AUX EXTRA” instead of “SOLAR.” This allows the solar plug (J17) on the EasyTouch motherboard to be used as an “extra” auxiliary output circuit. The **Down arrow** button is used to switch the “extra” auxiliary circuit on and off.*

To access the Solar menu:

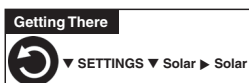

Solar

To enable a solar heater and set the temperature start and run time settings:

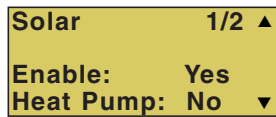

Up/Down buttons: Select **Yes** or **No** to enable solar (1/2). In order to display the solar selection as a heat source on the main screen, select **Yes**.

Right button: Move to the Heat Pump setting.

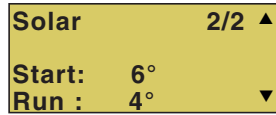

Up/Down buttons: Select **Yes** or **No** to enable solar as a heat pump. **Heat Pump Control instead of Solar:** Select **Yes** if a heat pump is being used in place of a solar heating system. If Solar is set to heat pump, Valve A is free for other circuits.

Right button: Select page 2 of 4 (2/4) to access the solar temperature differential start up and run settings.

Up/Down buttons:

Start: Set the temperature differential to start heating from 3° to 9°. For example, if “Start” is set to 3°, this ensures that the temperature has to deviate by 3° at least to the specified set point temperature (in the Heat menu, page 20) before it switches on. Once the solar comes on it will start converging as it is heating. This ensures that it will not continually be switching on and off.

Run: Set the temperature differential to stop heating from 2° to 5°. This setting sets how close to the target set point temperature to switch off solar heat.

 Press the Back button to save the settings and to return to the Settings menu options. Press the button again to return to the main menu options or press again to return to the Main screen.

Settings Menu: Delays

Setup which functions (pool/spa, and valves) to assign the delay feature. Delays can be assigned to the following equipment.

- **Heater Cool-Down Delay Cancel:** Shuts Filter Pump off immediately.
- **2-Speed Filter Pump five-minute START on HIGH SPEED Delay Cancel:** Shifts pump to low speed.
- **Automatic Pool Cleaner START Delay:** Starts Cleaner Pump immediately, without normal delay in which the filter pump first runs for 5 minutes.
- **Automatic Pool Cleaner SOLAR Delay:** Allows Cleaner Pump to run even though solar delay has shut it off for 5 minutes.

Some heaters require a cool-down cycle before being switched off. This can be setup to run the filter pump an additional ten minutes to dissipate residual heat built up inside the heater combustion chamber. You can also cancel the delay feature. For information about using the cancel delay feature, refer to “Delay Cancel” on page 21.

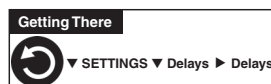

Delays

To assign the delay feature:



Press the **Up/Down buttons** to select **Yes** or **No** to enable or disable delays for the pool and spa circuits. Press the **Right button** to move to the valves setting. Press the **Down buttons** to select **Yes** or **No** to enable or disable delays for valves. Press the

 Back button to save and to return to the Settings menu options. Press the button again to return to the main menu or press again to go to the main screen.

Settings Menu: F° / C° (Fahrenheit/Celsius)

The temperature settings for the water, solar and air can be displayed in either Fahrenheit or Celsius.



F° / C°

To change the temperature units:



Up/Down buttons: Select either Fahrenheit or Celsius.

Press the Back button to save the settings and to return to the Settings menu options. Press the button again to return to the main menu options or press again to return to the Main screen.

Settings Menu: iS4 Spa-Side Remote Controller

You can specify any iS4 Spa-Side remote button to control different functions by assigning each button to a specific circuit. For example, you can use the iS4 Spa-Side remote to activate the spa circulation, and for operating three auxiliary pieces of equipment (such as heat enabled, lights, jet pump, heat boost, air blower, waterfall, etc.).



Assign iS4

Before configuring the iS4 Spa-Side remote controller assign names to the circuits (see page 26).

To assign iS4 Spa-Side buttons:

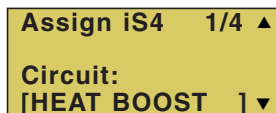

Up/Down buttons: Select a circuit to one of the iS4 buttons. You can set up to four circuits (1/4, 2/4, 3/4, 4/4).

Right button: Move to the circuit setting.

Up/Down buttons: To configure the first button on the iS4 Spa-Side Remote, scroll through the circuit names and find the circuit that you would like to assign to the first button on the iS4. The generic circuits selections are: None, Spa, Pool, Aux 1-7 (EasyTouch 8), Aux 1-3 (EasyTouch 4), Aux Extra, Heat Boost and Heat Enable. Selecting “None” does not assign a circuit. “Aux Extra” is only available if the Solar output (J17) plug on the EasyTouch motherboard is not being used for solar equipment. Use the **Down arrow** button to switch the “extra” auxiliary circuit on and off.

Note: The “Heat Boost” feature will switch on the heater for seven minutes to increase the spa water temperature. Each time the spa Heat Boost button is pressed, the temperature will increase about 1° F. The temperature will not go beyond the 106° F limit.

Right button: Assign the next circuit (2/4).

Up/Down buttons: Select the first digit for the circuit number (1/4, 2/4, 3/4, 4/4) and repeat the procedure for the other three buttons.

Press the Back button to save the settings and to return to the Settings menu options. Press the button again to return to the main menu options or press again to return to the Main screen.

Note: To disable or enable the iS4 Spa-Side remote, see Settings Menu: Spa Side,” on page 40.

Settings Menu: QuickTouch (QT4) Wireless Remote

The QuickTouch QT4 wireless remote controller provides switching of up to four circuits. For example, you can use the QT4 wireless remote to activate the spa circulation, and for operating three auxiliary pieces of equipment (such as heat enabled, lights, jet pump, heat boost, air blower, waterfall, etc.).

Each of the four functions on the QT4 wireless controller has an on and an off button. To switch a circuit on or off, press and hold the appropriate button for at least a full second.

The QT4 buttons can be assigned to any available circuit. However, the QT4 has the following preset circuits assigned to the four buttons:

- Spa button activates the spa circuit.
- A button activates **Auxiliary 1** circuit.
- B button activates **Auxiliary 2** circuit.
- C button activates **Auxiliary 3** circuit.

Assign QT4



To assign circuits to the QuickTouch wireless controller buttons:

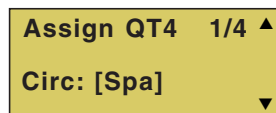

Up/Down buttons: Select a circuit to assign to one of the QuickTouch wireless remote buttons. You can set up to four circuits (1/4, 2/4, 3/4, 4/4).

Right button: Move to the circuit setting.

Up/Down buttons: To configure the first button (1/4) on the QuickTouch wireless remote. Use these buttons to scroll through the circuit names and find the circuit that you would like to assign to the first button. The generic circuits selections are: None, Spa, Pool, Aux 1-7 (EasyTouch 8), Aux 1-3 (EasyTouch 4), Aux Extra, Heat Boost and Heat Enable. Selecting “None” does not assign a circuit. “Aux Extra” is only available if the Solar output (J17) plug on the EasyTouch motherboard is not being used for solar equipment. Use the **Down arrow** button to switch the “extra” auxiliary circuit on and off.

***Note:** The “Heat Boost” feature will switch on the heater for seven minutes to increase the spa water temperature. Each time the spa Heat Boost button is pressed, the temperature will increase about 1° F. The temperature will not go beyond the 106° F limit.*

Right button: Assign the next circuit (2/4).

Up/Down buttons: Select the first digit for the circuit number (1/4, 2/4, 3/4, 4/4), then repeat the procedure for the other three buttons.

 Press the Back button to save the settings and to return to the Settings menu options. Press the button again to return to the main menu options or press again to return to the Main screen.

Settings Menu: Man Heat (Off/On)

By default manual heat (Man Heat) is set to “On,” which allows your spa to begin to heat whenever it is manually switched on, (by pressing the **Valves (V)** button and **Filter Pump** button on the main outdoor control panel or the **Spa** button on the wireless control panel), even if the Heat menu setting is set to “OFF” (see page 18). Your spa will also begin to heat when switched on by the iS4 Spa-Side remote. This feature allows you to program your spa to filter daily with the heater set to off, and then be ready to heat whenever the Spa button is pressed manually.



Man Heat

To enable or disable spa manual heat when switched on manually:

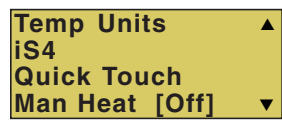

Right button: Select **Off** to disable or **On** to automatically begin spa heating whenever the spa is switched on manually.

Press the Back button to save the settings and to return to the Main screen.

Settings Menu: Calibration

The EasyTouch system includes two temperature sensors (10 kΩ) for water and ambient air temperature. You can also add an additional sensor for controlling solar heating systems. Generally, these sensors are accurate and you do not have to calibrate them. However, long plumbing runs and water features can cause temperatures at a body of water to be different from the temperature sensor reading. You can manually recalibrate the sensors to adjust for this. You only need to calibrate one body of water, since the temperature sensor is common to both the pool and spa. The system must be in “Service” mode to calibrate sensors.



Calibration

Before you start, you need an accurate all weather thermometer. If you are calibrating the air sensor, wait until the sensor is not in direct sunlight. For the air temperature sensor, make sure that the sensor is located in the shade for accurate readings.

To calibrate the water, air and solar temperature sensors:

1. Press the **Mode** button on the control panel to place the system in “Service” manual mode.
2. Press the **Filter Pump (F)** button to switch on the pool/spa filter pump.
3. Place the thermometer in the spa or pool water. Take an accurate temperature reading. When calibrating the air sensor, place the thermometer next to the air sensor. The air sensor is normally located near or under the EasyTouch load center enclosure, not inside the enclosure. Take an accurate temperature reading in the shade.
4. Use the **Up** or **Down** buttons to raise or lower the water temperature to match the corresponding thermometer temperature reading.
5. After calibrating the water sensor, use the **Right** button to move to the “AIR” setting and repeat step 4 and repeat the procedure for the solar sensor. Ensure that the solar sensor is in the sun for accurate readings.
6. After calibrating all the sensors, press the Back button to save the settings and to return to the Settings menu options. Press the button again to return to the main menu options or press again to return to the Main screen.

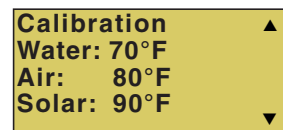

Settings Menu: Erase EEPROM (Erase System Memory)

EasyTouch system configuration data is stored and retained in “Flash” memory in an EEPROM located on the outdoor control panel motherboard, indoor control panel and wireless control panel. The EasyTouch user system configuration data can be erased to restore the factory defaults settings. System information automatically downloads from programmed components to non-programmed components in case of accidental memory loss and to ease board replacement. Any optional controllers (iS4, QuickTouch QT4 controller) that were configured will need to be reconfigured.

Erase EEPROM

The following procedure describes how to erase the system memory from either the main EasyTouch outdoor control panel or the EasyTouch wireless control panel.

CAUTION: This procedure will erase all system settings. Any optional controllers will need to be reconfigured.

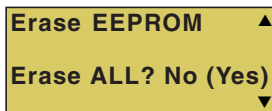

Up/Down button: Select **Yes**.

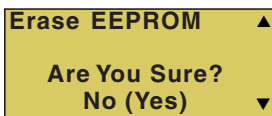

Right button: The message “Erase EEPROM Are You Sure? No” is displayed.
Up/Down button: Select **Yes**.

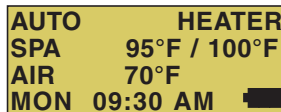

Right button: Press this button to erase system data and restore the factory defaults. The display will go blank, then the main screen will be displayed.

Settings Menu: Backlight

Use the backlight “On Time” option to set the duration that the backlight is on. The “Brightness” setting allows you to set the backlight brightness. These options can help to reduce power consumption and extend battery life. The Backlight options are:

- **On Time:** Backlight is on for 60 seconds, 30 seconds, five minutes, or off. The default setting is 30 seconds.
- **Brightness:** Backlight brightness can be set to low, medium or high. The default setting is medium.

Backlight

To set the backlight duration and brightness:

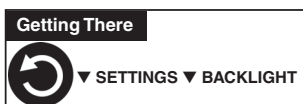

Up/Down buttons: Select **5 S**, **15 S**, **30 S**, **60 S**, **5 M** or **OFF** for the backlight duration.

Right button: Select **LOW**, **MED** or **HI** for the backlight brightness setting.

Press the Back button to save the settings and to return to the previous screen

Settings Menu: Power Save

This option sets the time that the EasyTouch wireless control panel will shut down if there is no control panel activity. Use the power save options to reduce power consumption and extend battery life. The options are:

- **Power save:** Set the power save time to 15, 30, or 60 seconds, or five minutes before the unit shuts down. The default time is 60 seconds.

Note: If the unit is not used for 60 (default) seconds the power save function switches off the unit. To switch the unit on, press the “POWER” button. The unit can also be switched off manually using the “Power Off” function, see page 44 for more information.

Idle Time

To set the idle time for the EasyTouch wireless control panel:

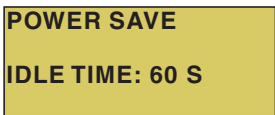
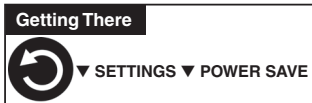

Right or Up/Down buttons: Select **30 S**, **60 S** or **5 M**.

Press the Back button to save the settings and to return to the previous screen.

Settings Menu: Wireless Addr

Use this feature to configure the EasyTouch wireless control panel using a unique communication address to allow the wireless device to operate with the EasyTouch outdoor control panel.

Wireless Addr

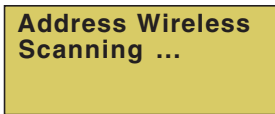

Right button: Press this button to automatically search and lock on to the EasyTouch wireless control panel within range of the EasyTouch transceiver antenna. For more information see Section 4, page 51.

Press the Back button to save the settings and to return to the Settings menu selections.

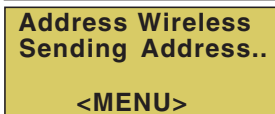

Spa Side [Off/On]

Enable or disable the iS4 Spa Side remote. This feature is useful for families with young children or when you go on vacation. It allows you to switch off the iS4 Spa Side remote at the control panel so that the remote cannot be used.

Spa Side

To enable or disable the iS4 Spa Side remote:

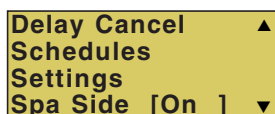

Right button: Select **On** or **Off** to enable or disable the spa side remote.

Press the Back button to save the settings and to return to the Main screen.

Diagnostics Menu: Software Rev

Displays the current software revision for the EasyTouch main control panel and the wireless control panel.

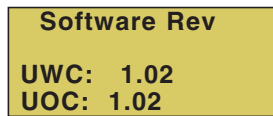

UWC: Displays the current software revision level for the wireless or indoor control panel.

UOC: Displays the current software revision level for the outdoor control panel.

 Press the Back button to return to the Settings menu options. Press the button again to return to the main menu options or press again to return to the Main screen.

Diagnostics Menu: Bootloader Rev

Displays the current bootloader revision for the wireless control panel and the EasyTouch outdoor control panel.

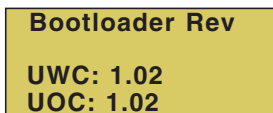

UWC: Displays the current bootloader revision level for the wireless or indoor control panel.

UOC: Displays the current bootloader revision level for the outdoor control panel.

 Press the Back button to return to the Settings menu options. Press the button again to return to the main menu options or press again to return to the Main screen.

Diagnostics Menu: Self Test

Tests the EasyTouch wireless control panel LCD and buttons. Follow the on-screen prompts to perform the tests.

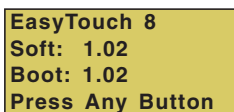

Press the **Right** button to display the current software and bootloader revision levels for the EasyTouch wireless control panel.

Press the **Right** button to start the test:

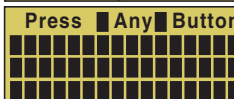

Display Test: Press any button to start the LCD test.

Backlight Test: Press the **Left** then **Right** button.

Contrast Test: Press any button to continue.



LED Test: Press any button to continue. All of the button LEDs will be tested.

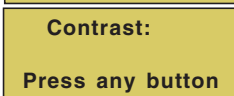

Switch Test: Press any button to continue. As prompted, press the appropriate buttons.

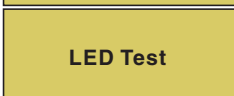

Status: Passed - Code: None After you have completed the test an error code is displayed. If the test was successful, “Passed” is displayed. For error code descriptions, see “Self Test Error Codes,” on page 46.

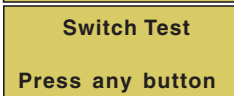

 Press the Back button to return to the Settings menu options. Press the button again to return to the main menu options or press again to return to the Main screen.

Diagnostics Menu: Chlorinator

Displays the current IntelliChlor chlorination system status. For more information, refer to the IntelliChlor Electronic Chlorine Generator User's Guide (P/N 520589).



Chlorinator ▲
Salt Level:3200ppm
Status:
[OK-NO ERRORS] ▼

Menu: Press this button to return to the Settings menu options. Press the button again to return to the main menu options or press again to return to the Main screen.

SALT LEVEL: Displays the current salt level. Values from 0 to 12750 ppm in 50 ppm increments.

IntelliChlor Status messages:

SUPER CHLORINATE: IntelliChlor is in "Super Chlorination mode (see page 28)

COM LINK ERROR: Check cable from IntelliChlor to EasyTouch motherboard.

Check FLOW/PCB: Check IntelliChlor electrolytic cell controller. Refer to IntelliChlor User's Guide troubleshooting information.

LOW SALT: Add salt to pool water. The water salt level is between 2500 ppm and 2900 ppm. The IntelliChlor will continue to produce chlorine at a reduced level.

VERY LOW SALT: Not enough salt in pool. The water salt level has fallen below 2500 parts per million (ppm). IntelliChlor will not produce chlorine until additional salt is added manually.

HIGH CURRENT: Check IntelliChlor electrolytic cell controller. Refer to IntelliChlor User's Guide troubleshooting information..

CLEAN CELL!: Cell has calcium build up and requires cleaning. Refer to IntelliChlor User's Guide for cleaning instructions.

LOW VOLTAGE: Check IntelliChlor electrolytic cell controller. Refer to IntelliChlor User's Guide troubleshooting information.

OK - NO ERRORS: IntelliChlor is in normal operating mode.

Diagnostics Menu: Water Temp

Displays the current water temperature for the pool and spa.



Water Temperature ▲
75° F ▼

⌂ Press the Back button to return to the Settings menu options. Press the button again to return to the main menu options or press again to return to the Main screen.

Diagnostics Menu: Solar Temp

Displays the current temperature.



Solar Temperature ▲
85° F ▼

⌂ Press the Back button to return to the Settings menu options. Press the button again to return to the main menu options or press again to return to the Main screen.

Diagnostics Menu: Air Temp

Displays the current outside air temperature.

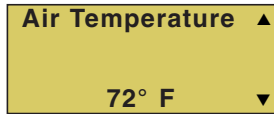
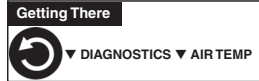

Press the Back button to return to the Settings menu options. Press the button again to return to the main menu options or press again to return to the Main screen.

Diagnostics Menu: Disp Codes

Perform a communications test with installed equipment. Use this feature when testing the system.

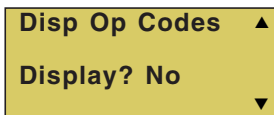
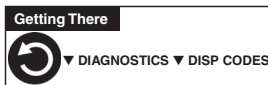

To start test:

Down button: Select **Yes** to enable the feature.

Menu or Right button: Press either of these buttons to start communications test. Digits display on the right side of all menu screens indicating verification transmit and received packets.

To stop test: Go to the “Disp Op Codes” menu and select **No**, then press the **Back** button to exit.

Diagnostics Menu: Cir Names: [Off/On]

This feature is useful if you have renamed many circuits and want to view the original factory default circuit names.

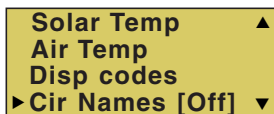

To enable:

Right button: Select **On** to view the factory default circuit names.

Menu: Press this button to exit.

To disable:

Right button: Select **Off** to disable the feature.

Press the Back button to exit.

Diagnostics Menu: Reset System

Reset the EasyTouch wireless control panel. Resetting the wireless control panel will not affect the stored system configuration settings.

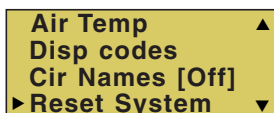

Right button: Press the Right button to reset system. The main screen will be displayed and communication will be established with the EasyTouch outdoor control panel at the pool equipment pad.

Diagnostics Menu: Flash Update

Use this feature to update the EasyTouch wireless control panel firmware. The unit must be connected to a personal computer (PC) in order to update the firmware.



Press  **Back button to exit the flash mode.**

Power OFF

The “Power Off” function switches off battery power to the EasyTouch wireless control panel. Use this function to manually switch off the unit. To switch the unit on, press the Power ON button.



Right button: Press the Right button to switch off the unit.

Section 3

Troubleshooting

Troubleshooting

Use the following troubleshooting information to help resolve problems that may occur when using the EasyTouch system. If by following the recommended actions you are still unable to resolve the problems, please contact Technical Support (see page vi).

Frequently Asked Questions (FAQ)

How do I setup a two-speed pump?

A two-speed pump operates using two relays and one or more circuits. The first relay turns the pump on or off. Assuming this is a filter pump, this circuit is controlled by the pool and spa circuits or any other circuit that may be tied to the filter pump (such as circuits with freeze protection, etc.). The second relay switches the pump from low speed to high speed. The default condition is low speed. Up to seven circuits (EasyTouch 8), three circuits (EasyTouch 4) may be assigned to trigger the pump to high speed. Note: These circuits do not switch the pump on.

To configure a two-speed pump relay, refer to “Settings Menu: 2-Speed Pump,” on page 34. The 2-Speed pump relay connector is plugged into the 2-SPD output on the EasyTouch motherboard.

Can I switch the heater on and change the temperature from the spa?

The heater may be switched on from the spa location using the iS4 Spa-Side remote or by the QuickTouch wireless remote controller. However, the iS4 and QuickTouch wireless remote controller cannot adjust the water temperature.

How do I switch on solar heating?

The system must first be configured for solar heating. Go to the “Heat” menu (see page 20) and enable “Solar” as the heat source (**Settings Menu: Heat > Solar**). Note: Do not set solar as a heat pump. Then the heating method must be selected for each body of water.

EasyTouch Error Messages

Error Messages

If the system detects that a sensor is not connected to the EasyTouch load center or it is defective, an error message is displayed in the “Diagnostics” menu. The following lists the sensor errors.

Error Message	Possible Cause	Solution
Air Err (Displays on the Main Screen)	Air sensor not connected to the EasyTouch motherboard.	Check that the air sensor plug is connected to J21 connector on the motherboard. Check that the sensor wire is connected properly.
Air Temperature Err (Displays in the "Diagnostics" menu)	Air sensor not connected to the EasyTouch motherboard.	Check that the air sensor plug is connected to J21 connector on the motherboard.
Water Temperature Err (Displays in the "Diagnostics" menu)	Water sensor not connected to the EasyTouch motherboard.	Check that the water sensor plug is connected to J21 connector on the motherboard.
Solar Temperature Err (Displays in the "Diagnostics" menu)	Solar sensor not connected to the EasyTouch motherboard.	Check that the solar sensor plug is connected to J21 connector on the motherboard.

Self Test Error Codes

The “Self Test” feature is intended for use by service personnel. If after performing a control panel self test (see page 41) there were no errors detected, Code 0 is displayed, indicating that there were no problems and the test was successful. If a problem is detected during the test, an error code is displayed upon completion of the test. For example Code 3 would indicate a problem with the LEDs on the control panel. If multiple errors are detected, multiple code numbers are displayed. For example, Codes 4, 2, 1, would indicate problems detected with the buttons, LEDs, and the LCD backlight on the control panel.

The following lists the control panel self test error codes.

Error Code Table

Error Code	Description
Code 0	PASS - The control panel has no problems
Code 1	LCD backlight
Code 2	LCD contrast
Code 3	LEDs
Code 4	Switch (buttons)

Maximum Programs Exceeded

The “Maximum Programs Exceeded” message displays in the “Schedules” menu if you try to create a new program after exceeding the 12 program limit. To create a new program you must first delete an existing program. For information about deleting a program, refer to “Schedule Menu” on page 22.

IntelliChlor Error Messages

IntelliChlor status and error messages are displayed in the “Chlorinator” menu (see page 42). Use the following information to resolve IntelliChlor system problems. To access the IntelliChlor menu, press **Menu > Diagnostics > Chlorinator**.

Status Message	Possible Cause	Solution
OK-NO ERRORS	IntelliChlor normal operating mode.	N/A
SUPER CHLORINATE	IntelliChlor is in "Super Chlorination" mode for 24 hours.	IntelliChlor is in “Super Chlorination mode (see page 28 for details)
COM LINK ERROR	IntelliChlor communication error with EasyTouch motherboard.	Check cable from IntelliChlor to EasyTouch motherboard.
CHECK FLOW/PCB	Check IntelliChlor electrolytic cell.	Refer to IntelliChlor User’s Guide troubleshooting information.
LOW SALT	Add salt to pool water.	The water salt level is between 2500 ppm and 2900 ppm. The IntelliChlor will continue to produce chlorine at a reduced level. See IntelliChlor User’s Guide for details.
VERY LOW SALT	Not enough salt in pool.	The water salt level has fallen below 2500 parts per million (ppm). IntelliChlor will not produce chlorine until additional salt is added manually. See IntelliChlor User’s Guide for details.
HIGH CURRENT	Check IntelliChlor electrolytic cell.	Check IntelliChlor electrolytic cell controller. Refer to IntelliChlor User’s Guide troubleshooting information.
CLEAN CELL!!	Cell has calcium build up and requires cleaning.	Cell has calcium build up and requires cleaning. Refer to IntelliChlor User’s Guide for cleaning instructions.
LOW VOLTAGE	Check IntelliChlor electrolytic cell.	Refer to IntelliChlor User’s Guide troubleshooting information.

System Problem Diagnosis

Use the following information to resolve system problems.

Problem: The system works in Service Mode, but wireless control panel fails to operate.

Symptom	Possible Cause	Solution
Indoor Control Panel has no power - (screen, blank, no LEDs, buttons not working).	Bad wiring run from Outdoor Control Panel/motherboard in the Load Center.	Verify cable and ensure no connections are broken. In some cases a wire is broken under the insulation. The two center wires of the four conductor cable are suspect (Green and Yellow)
Indoor Control Panel lights up, but fails to operate correctly. The unit will not turn equipment on/off, or may turn some items on, but not off and may not LEDs near buttons on control panel.	Defective Cable/wiring	Verify cable and ensure no connections are broken. In some cases a wire is broken under the insulation. The two center wires of the four conductor cable are suspect (Green and Yellow)

Problem: iS4 fails to operate.

Symptom	Possible Cause	Solution
iS4 fails to operate equipment.	iS4 is disabled.	See page 40 to enable the iS4.
	Defective Wiring	Verify iS4 setup. Ensure the iS4 in question has the expected circuit assignments, and is not assigned to unused circuits.
	Incorrect configuration or button setup.	See page 36 to setup the iS4 buttons.
	Defective iS4	Replace defective iS4
iS4 fails to operate only some of the switches, but others work fine.	Defective wiring on one or more iS4 leads	Verify wiring on motherboard and iS4.
	Incorrect configuration or circuit to switch assignment.	Verify motherboard connection.

Problem: The Quick Touch remote will not work, or will not work dependably.

Symptom	Possible Cause	Solution
POWER LED does not light on the Receiver board located in the plastic clam shell.	EasyTouch Load Center does not have power	Ensure power is being supplied and that the power center operates correctly without the receiver installed
	Defective cable or connection to the Load Center	Verify the function of the board using known good cable set. Check all wiring
	Defective Receiver board	Contact Technical Support
COMM LINK LED does not light or blink. In normal operation LED will blink at least every 2 seconds	Defective cable or connection to the Load Center	Verify the function of the board using known good cable set
	Defective receiver board	Replace receiver board
Address switches are incorrectly configured	Verify that the address switches on the transmitter and handheld receiver board are correct and match	Transmitter battery has failed
	Replace Transmitter battery	Defective Transmitter or Receiver
	Unit functions, but some circuits do not work, or operate the incorrect circuit	QuickTouch configuration is incorrect
Unit functions, but some circuits do not work, or operate the incorrect circuit	QuickTouch configuration is incorrect	See page 37 to setup buttons Unit fails to operate, or fails to operate dependably at range
Unit fails to operate, or fails to operate dependably at range	Excessive electrical noise	Relocate the receiver away from ""noisy"" electrical equipment such as blower motors
	Too many obstructions between the transmitter and receiver	Relocate the receiver away from ground metal and obstructions
	Receiver unit is too near the ground	Relocate the receiver to maximize the distance between the receiver antenna and the ground

Problem: The Quick Touch remote will not work, or will not work dependably (Continued).

Symptom	Possible Cause	Solution
Unit seems to turn on or off circuits without the user / transmitter	A near by home is operating a similar wireless unit	Select an alternate address code for the transmitter and receiver. Change the switches on both receiver and remote to an alternate, but matching setting.
Unit dependably turns equipment ON, but once equipment is running it does not dependably turn equipment OFF, or range is greatly reduced when equipment is running	Undue electrical noise is being produced by one or more pieces of equipment in close proximity to the receiver.	Relocate the Receiver away from equipment such as blower motorsRelocate the Receiver in a location that provides fewer obstructions to the area the user commonly operates the transmitter.
Unit operates, but has greatly reduced range compared to prior function	Transmitter battery is failing.	Replace Transmitter battery (type 2032 3V).

EasyTouch Transceiver Installation

Installing the EasyTouch Transceiver

The following procedure describes how to install the EasyTouch transceiver module and connect the transceiver cable to the COM port on the EasyTouch motherboard. Read through the installation procedure before starting.

EasyTouch wireless control panel kit

The EasyTouch wireless control panel kit consists of:



- EasyTouch wireless control panel
- Four AA-size alkaline batteries
- Transceiver module
- Four plastic anchors and retaining screws (to mount the transceiver module)

Mounting the EasyTouch Transceiver

The Transceiver is a two-way radio device with an attached antenna that communicates to and from the EasyTouch system via the wireless hand-held wireless control panel. Mount the Transceiver module at a convenience location (on a flat vertical surface) near the Load Center, at a minimum of 5 ft. above ground level to optimize the functional operating range of the wireless control panel.

 **CAUTION** - To avoid signal interference, mount the Transceiver antenna a minimum of 10 ft. away from the Load Center, any metal surface/structure, or air blower located in the immediate area of the equipment pad.

To mount the EasyTouch transceiver near the EasyTouch load center:

1.  **CAUTION** - Switch the main power off at the EasyTouch load center.
2. Remove the two retaining screws securing the transceiver case to the back plate. Carefully slide the case off the back plate.
3.  **CAUTION** - Electrostatic Discharge (ESD): Hold the circuit board from the edges. Do not touch the board components, electrostatic discharge can damage the board. Slide the transceiver circuit board up and out of the back plate.
4. Position the back plate against the mounting surface so that the case is oriented in an upright position (with the antenna pointing upwards). Use a pencil to mark the four mounting points. Drill four 3/16 in. diameter holes into the mounting surface. If screws are not being used, insert the four plastic wall anchors (provided in the kit).
5. Feed the provided 10 ft. of UL approved four 22 AWG conductor cable through the knockout hole at the bottom of the enclosure. Do not run wire through the drain holes. If the knockout hole is not being used to run wire through, drill a hole through the bottom of the back plate, route the wire through the hole and seal it using a fitting with a few feet of conduit or some other sealant between the case and the cable.

6. Position the back plate over the mounting points and secure it with the four mounting screws (provided in the kit).
7. Carefully slide the transceiver circuit board into the back plate.
8. Strip the leads of the communication cable wires back ¼ in. Insert the wires into the connector screw terminals (provided in the kit). Using a small flat-blade screwdriver, secure the wires with the terminal screws. Make sure to match the color-coding of the wires: GND = Black, Green = -DT, Yellow = +DT, and Red = +15. Connect the screw terminal connector onto the transceiver circuit board.
9. Slide the case over the back plate. Secure the case to the back plate using the two retaining screws.
10. Proceed with **“Connecting the Transceiver to the EasyTouch Load Center,”** on page 53.

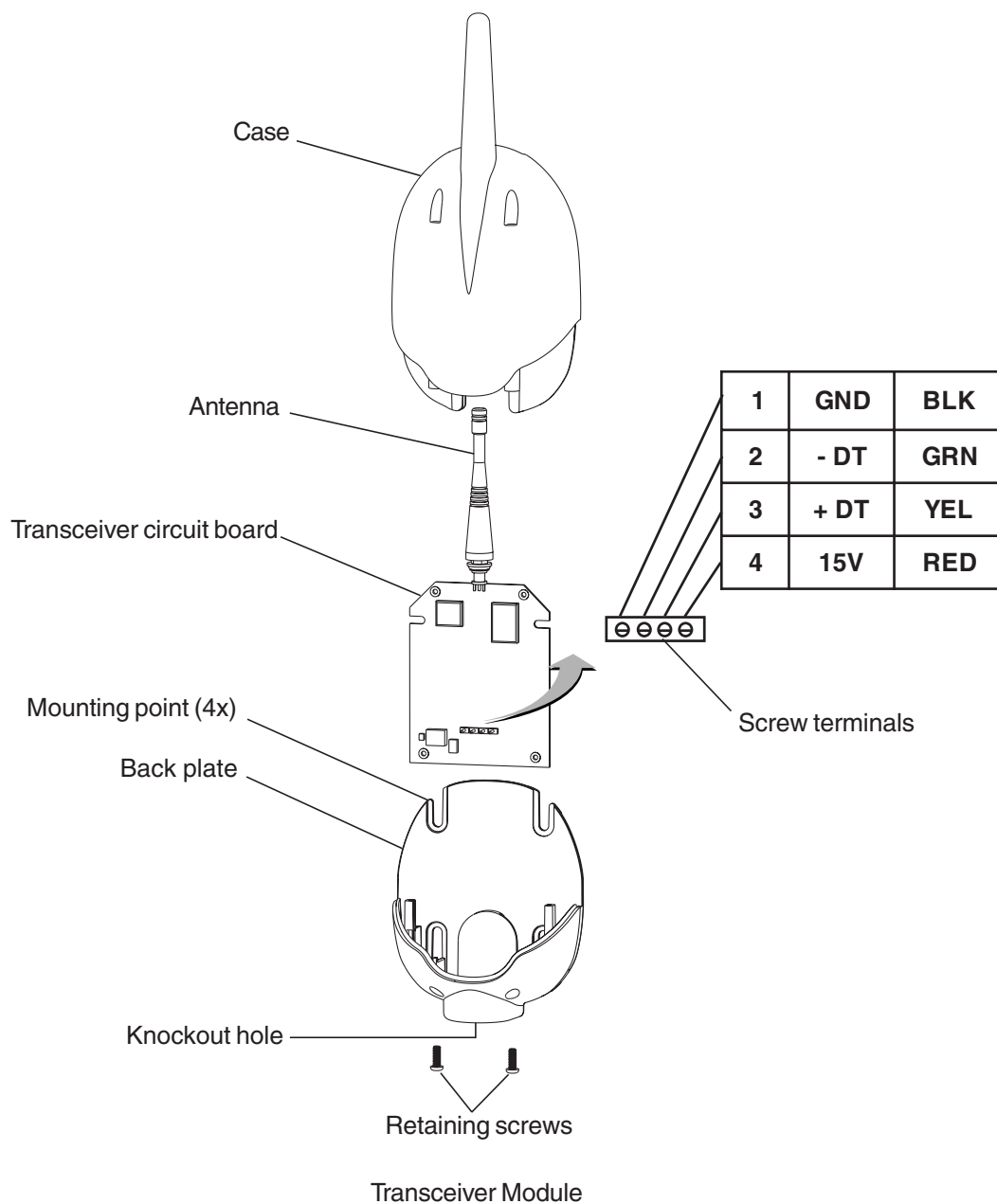

Connecting the Transceiver to the EasyTouch Load Center

WARNING - Switch OFF the main system power to the EasyTouch load center before making any connections.

1. Unlatch the two enclosure door spring latches, and open the door.
2. Remove the two retaining screws securing the high voltage cover panel, and remove it from the enclosure.
3. Loosen the two access screws securing the control panel.

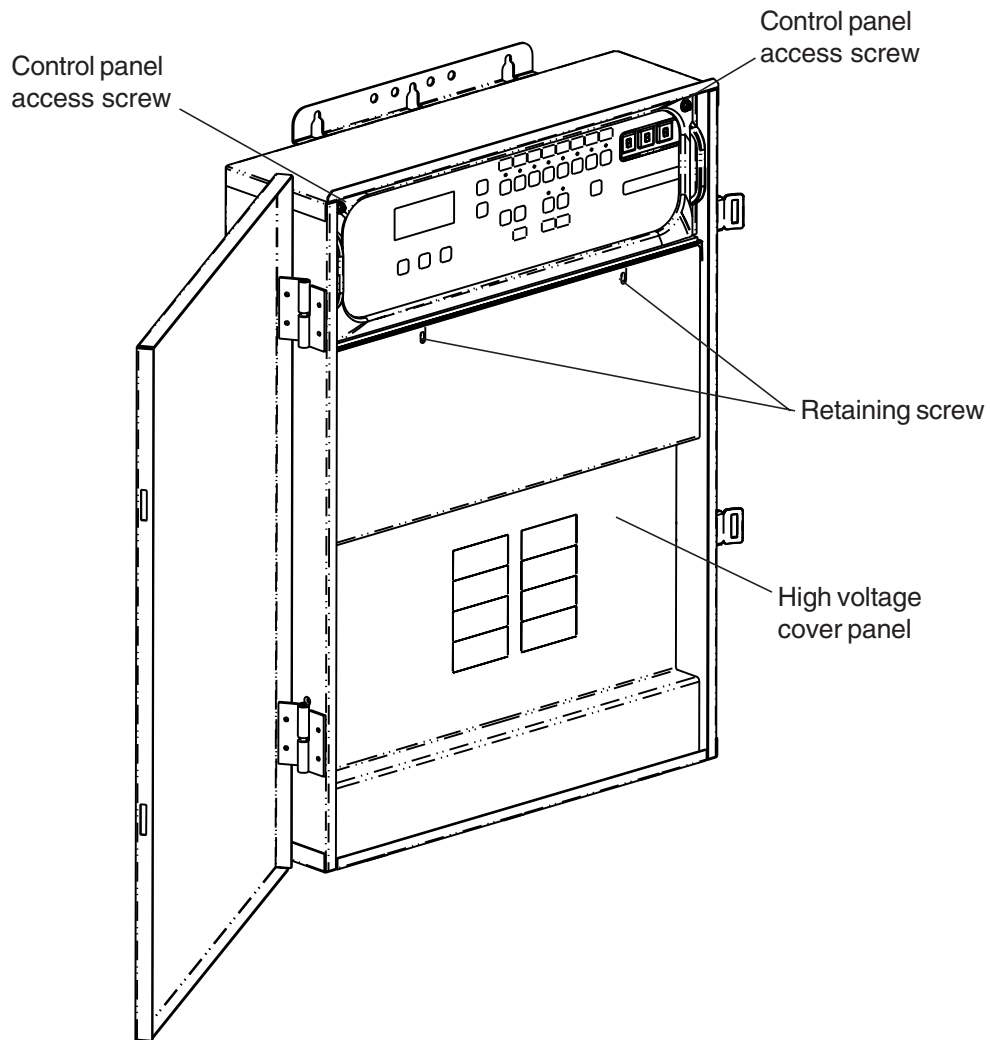

EasyTouch Load Center (front view)

4. Lower down the hinged control panel to access the EasyTouch motherboard.
5. Route the four conductor transceiver connection cable into the lower plastic grommet, up through the low voltage raceway to the EasyTouch load center motherboard.
6. Strip back the cable conductors ¼ inch. Insert the wires into the screw terminals (provided in the kit). Secure the wires with the screws. Make sure to match the color-coding of the wires:
GND = Black, Green = -DT, Yellow = +DT, and Red = +15
7. Insert the screw terminal connector onto the **COM-PORT (J20)** connector on the motherboard.
Note: Multiple wires may be inserted into a single screw terminal.

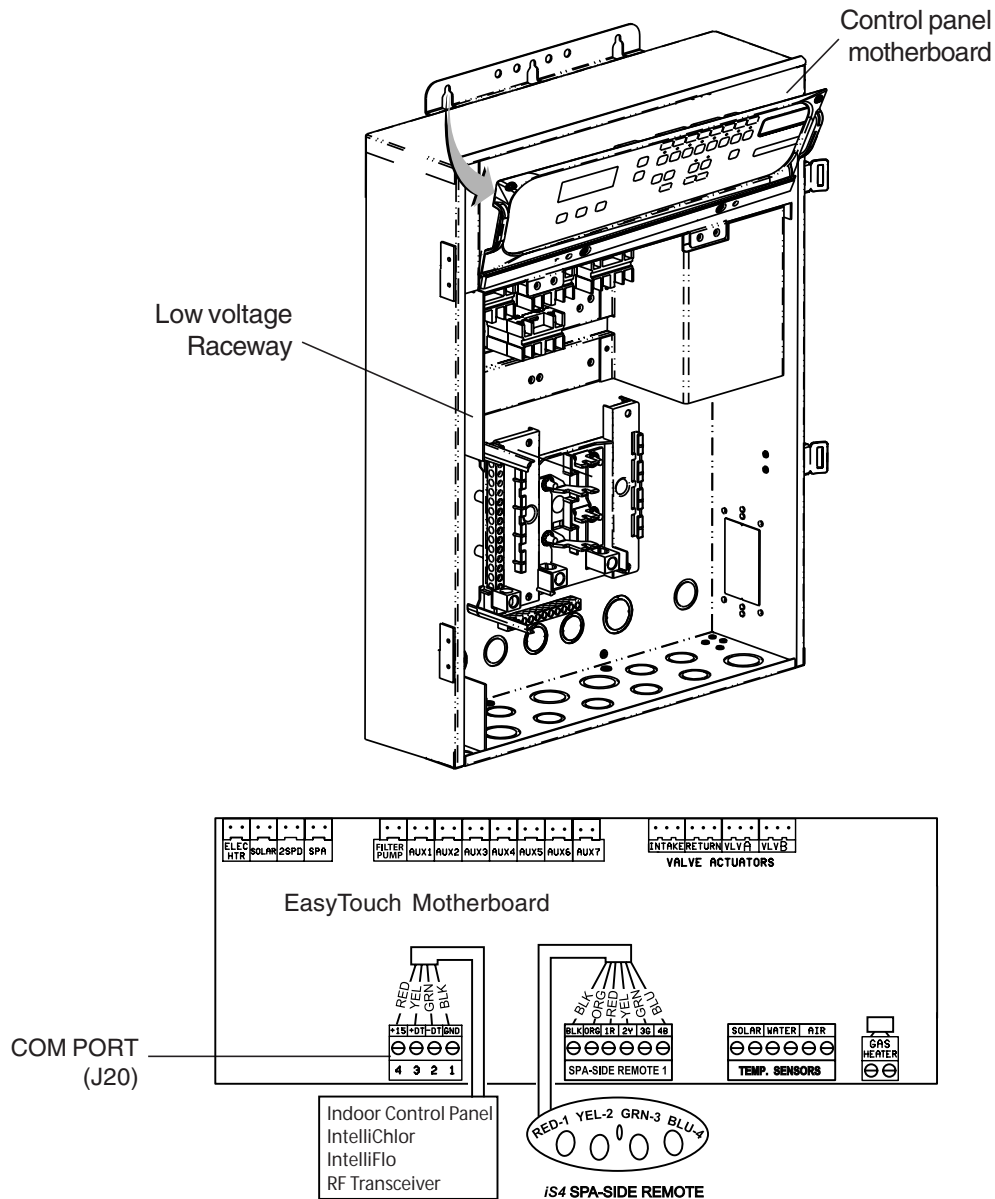

8. Close the control panel into its original position and secure it with the two access screws.
9. Install the high voltage cover panel and secure it with the two retaining screws.
10. Close the EasyTouch load center front door. Fasten the two spring latches.
11. Switch the power on to the EasyTouch load center.

Glossary

Aux Extra: An additional auxiliary output circuit that uses the Solar socket (J17) on the EasyTouch motherboard. Uses the Down arrow button on the wireless control panel to switch circuit on and off. Only available if solar equipment is not being used.

High Voltage Compartment: Large lower right compartment of Load Center for all high voltage wiring including circuit breakers, relays, and GFCI.

Indoor Control Panel: Nine or 14 button remote controller with LCD (liquid crystal display) wired to the EasyTouch motherboard in the load center. The Indoor control panel can be wall mounted inside the house.

iS4: Four function Spa-Side remote. Can be spa wall or deck mounted.

Load Center: Metal enclosure with power relays, transformer, and circuit breakers. Used for distributing power for controlling the EasyTouch system. Also known as the “sub-panel.”

Low Voltage Compartment: Top compartment of Load Center for all low voltage wiring.

Low Voltage Raceway: Vertical space in the left side of EasyTouch load center for low voltage cabling.

Indoor Control Panel: EasyTouch control panel with flexible hinge installed in upper portion of EasyTouch Load Center to control the EasyTouch system.

Motherboard: The circuit board mounted on top of the EasyTouch control panel. The EasyTouch motherboard defines the system capabilities.

Receiver/Antenna: Used with the QuickTouch (QT4) to receive radio frequency (wireless) transmissions.

RF Transceiver: Used with the EasyTouch wireless control panel to transmit and receive radio frequency (wireless) transmissions.

Relay Circuits: The circuits that control the relay outputs on the EasyTouch motherboard. Connectors are located on the top edge of the circuit board.

Screw Terminal Connector: Removable connector that may attach to circuit board with multiple sockets (anywhere from 2 to 12) to receive wires from controllers and sensors; wires held by screw terminals; multiple wires of a small enough gauge (usually 22 AWG) may be coupled to a single socket of a terminal connector. Sockets are located on the EasyTouch motherboard.

Notes

Notes

Notes

