

# MasterMind

Remote Control Automated System

## Owners Manual and Installation Guide

E-1709

7/00



"The Most Trusted Name In Water."™

# TABLE OF CONTENTS

1. INTRODUCTION .....	1
2. PRODUCT DESCRIPTION .....	2
3. SAFETY INSTRUCTIONS .....	3
4. SPECIFICATIONS .....	4
5. CONTROL BOX MOUNTING INSTRUCTION .....	4
6. SYSTEM POWER WIRING .....	6
7. WIRING INSTRUCTIONS (RELAYS AND TERMINAL BLOCKS) .....	8
7.1 Relay K1 (Single-Speed, Primary Pump Relay Wiring .....	10
7.2 Relay K2 Through K7 .....	14
7.3 Relay K8 (Electric Valve Actuators) .....	18
7.4 Optional Relay Positions K9 & K10 (Max 20 amp, 3 hp) .....	20
7.4.a Alternate Controls for Channels 2 Through 7 .....	20
7.4.b Alternate Controls for Channel 8 .....	24
7.5 Two Speed Wiring .....	28
7.6 Wiring Additional Time Clocks .....	32
7.7 Automatic Freeze Protection Wiring .....	34
7.8 Heater control (Single Thermostat “On/Off” .....	36
7.9 Heater Control (Switching Dual Thermostats) .....	38
PROGRAMMING INSTRUCTIONS.....	41

# 1. INTRODUCTION

## *Congratulations on your choice of Jacuzzi's MasterMind™ Remote Control Automation System.*

Total control of your backyard environment may now be achieved with the touch of a button. Depending on your specific pool/spa/landscape plan, you may control multiple pumps, two-speed pumps, electric valves, multiple heater thermostats, waterfalls, fountains, pool lighting, landscape lighting, solar panels, or a myriad of other accessories that may be a part of your backyard paradise.

This Instruction Manual contains detailed instructions on how to install most of these components or accessories to your MasterMind System. Please read all instructions carefully.

*Thank you for choosing the MasterMind Remote Control Pool Automation System!*



## 2. PRODUCT DESCRIPTION

Your new **MasterMind™** Remote Control Pool Automation System comes in two (2) basic models. The MM-4 is a four channel digital receiver/controller; the MM-8 is an eight channel digital receiver/controller. Other model variations (MM4-ACT; MM8-ACT) include Jacuzzi **Valve Minder™** electric valve actuators or (MM4-ACT-V; MM8-ACT-V) Jacuzzi Valve Minder electric valve actuators **and** 3-way valves. All MasterMind™ Systems have solid state outputs designed for use with MasterMind™ “hand-held” remote control transmitters. When the MasterMind™ Control Box receives a signal from the “hand-held” transmitter(s) programmed into its memory, it activates whichever piece of equipment, “appliance”, or accessory that is connected to the specific MasterMind™ channel that receives the signal.

Each MasterMind™ System incorporates a dual diversity superheterodyne digital high-sensitivity receiver with two whip antennas. This type of receiver provides superior performance by preventing loss of signal due to multi-path interference. An Automatic Level Control (ALC) circuit adjusts the receiver’s sensitivity depending on surrounding conditions.













The digital DX/DXS remote control code format features over a million possible codes. For versatility, any MasterMind™ transmitter can be programmed into any MasterMind™ receiver channel. Receivers must be programmed to recognize the transmitter’s code before system testing and operation. Once programmed, the receiver will not accept signals from any other source. In essence, the remote control transmitter and receiver are “slaved” to one another. Up to 16 transmitters can be programmed into each receiver. Each button on the multi-button “hand-held” transmitter sends a unique code and is programmed as a separate transmitter.

The MasterMind™ System has a CHANNEL DISPLAY on the radio receiver board that shows the channels that are currently activated. The Channel Display indicates whether or not the unit is receiving a radio signal from its “slaved” transmitter(s) and also alerts you to a **LOW BATTERY**.

The MasterMind™ Remote Control System is UL approved and housed in a corrosion-proof and water-proof enclosure.

## 3. SAFETY INSTRUCTIONS

### **WARNING! READ BEFORE INSTALLING**

-  Read and follow all instructions.
-  Before installation, maintenance, or service, be certain that the power supply to all electrical connections or applicable circuit breakers is shut “**OFF**” to avoid risk of electrical shock and injury.
-  **WARNING!** To reduce the risk of injury, do not permit children to use this product unless they are closely supervised at all times.
-  This unit is potentially hazardous if not properly installed.
-  Install and locate this remote control system in accordance with the installation instructions. Install at least five (5) feet from the inside of the pool and/or spa.
-  The MasterMind System must be installed in conformance with the National Electric Code and all local code requirements.
-  If a ground fault circuit interrupter is used on the load side of a circuit: the field installed conductors shall not occupy conduit, boxes, or enclosures with conductors of other circuits unless all other conductors are also on the load side of a ground fault circuit interrupter.
-  The total electrical system must be installed, tested, and approved by a licensed electrician before the MasterMind System is placed in operation.
-  The transformer located inside the MasterMind remote control system’s enclosure must be grounded to meet Section 13 of UL 1563.
-  All metal conduit must be grounded.
-  The MasterMind System location and height shall be in accordance with all local wiring codes and/or NEC.
-  Save these instructions.

## 4. SPECIFICATIONS

**Power Supply:** 110 volts AC, 60 Hertz, 5 amps

**Relay Contact Rating:**

K1: 20 amps; 1-HP, 110 Volt; 2-HP, 220 Volt

K2 through K7: 8 amps per pole; 1/2 HP, 110 Volt; 1HP, 220 Volt

K8: maximum 3 electric valve actuators

**Effective Transmitter Range:** 700 Feet

## 5. CONTROL BOX MOUNTING INSTRUCTIONS

1. Install the control box at least five (5) feet from the inside wall of the pool and/or spa.
2. Establish a mounting location for the MasterMind Control Box close to the electrical panel or pool/spa subpanel. The mounting location will need to accommodate conduit for wiring between the electrical panel/subpanel and the MasterMind Control Box, as well as between the MasterMind Control Box and the specific equipment or accessories it controls.
3. Using the supplied mounting brackets and fasteners, attach each bracket to the back side of the MasterMind enclosure as shown in **Figure A**. Tighten the screws firmly, but do not overtighten. Overtightening could strip the brass inserts from the enclosure.
4. Using the slots in the mounting brackets, mount the MasterMind Remote Control System using hardware appropriate for outdoor installation. Make sure that the enclosure is securely attached.
5. Drill the appropriate hole(s) in the bottom of the MasterMind enclosure to accommodate conduit. (**NOTE: To keep the MasterMind's UL listing, no holes can be drilled through the enclosure above the location of the power terminal blocks mounted inside the unit as indicated in Figure B**)
6. Connect conduit between the MasterMind enclosure and the electrical panel or pool/spa subpanel. If metallic conduit is used, be certain that the conduit is grounded to the grounding bar located inside the electrical panel/subpanel. Each section of conduit shall house only as many conductors as the National Electric Code (N.E.C.) or your local electrical codes allow.
7. Wire the MasterMind Remote Control System according to the following wiring instructions.

*Figure A*



*Figure B*

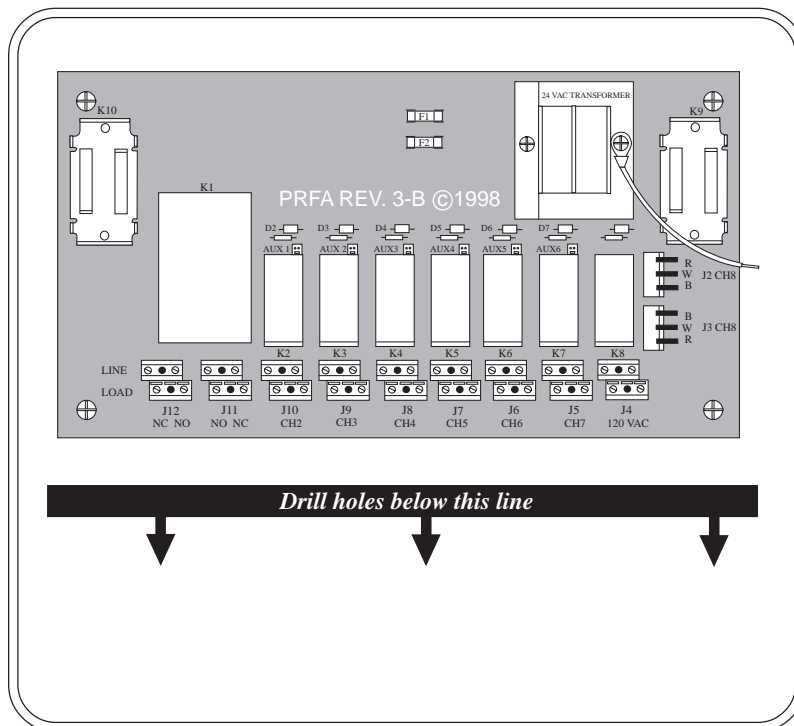

## 6. SYSTEM POWER WIRING

1. Before installation, be certain that the power supply to all electrical connections or applicable circuit breakers is shut “**OFF**” to avoid risk of electrical shock and injury.
2. **Terminal block J4** has been reserved for connecting electrical power to the MasterMind™ control box to power the transformer, the time clock, and the radio board. J4 is designed to accommodate 110 VAC @ 60 Hz and is located on the far right-hand side of the terminal blocks. To help you in locating terminal block J4, the factory installed time clock is connected to J4 with one black and one white 12 AWG wire.  
**NOTE: Do not attempt to connect 220 VAC to terminal block J4.**
3. Bring a wire from the circuit breaker that will control the system power and connect it to the **top row** (LINE connection) of **terminal block J4** in the slot adjacent to the time clock black wire (LINE connection). Strip the wire to approximately 3/8 inch. Loosen screw and insert end of wire. Tighten screw and tug wire to make sure it is secure.
4. Connect a neutral wire (white) between the neutral connection in the electrical panel/subpanel and the **bottom row** of **terminal block J4** in the slot adjacent to the time clock white wire (neutral connection). Strip the wire to approximately 3/8 inch. Loosen screw and insert end of wire. Tighten screw and tug wire to make sure it is secure.
5. Complete the system power wiring by connecting a ground wire (green) between the ground connection in the electrical panel/subpanel and the green wire lead connected to the 24 volt transformer on the MasterMind relay board. Make certain all connections are secure.



# System Power Wiring Diagram

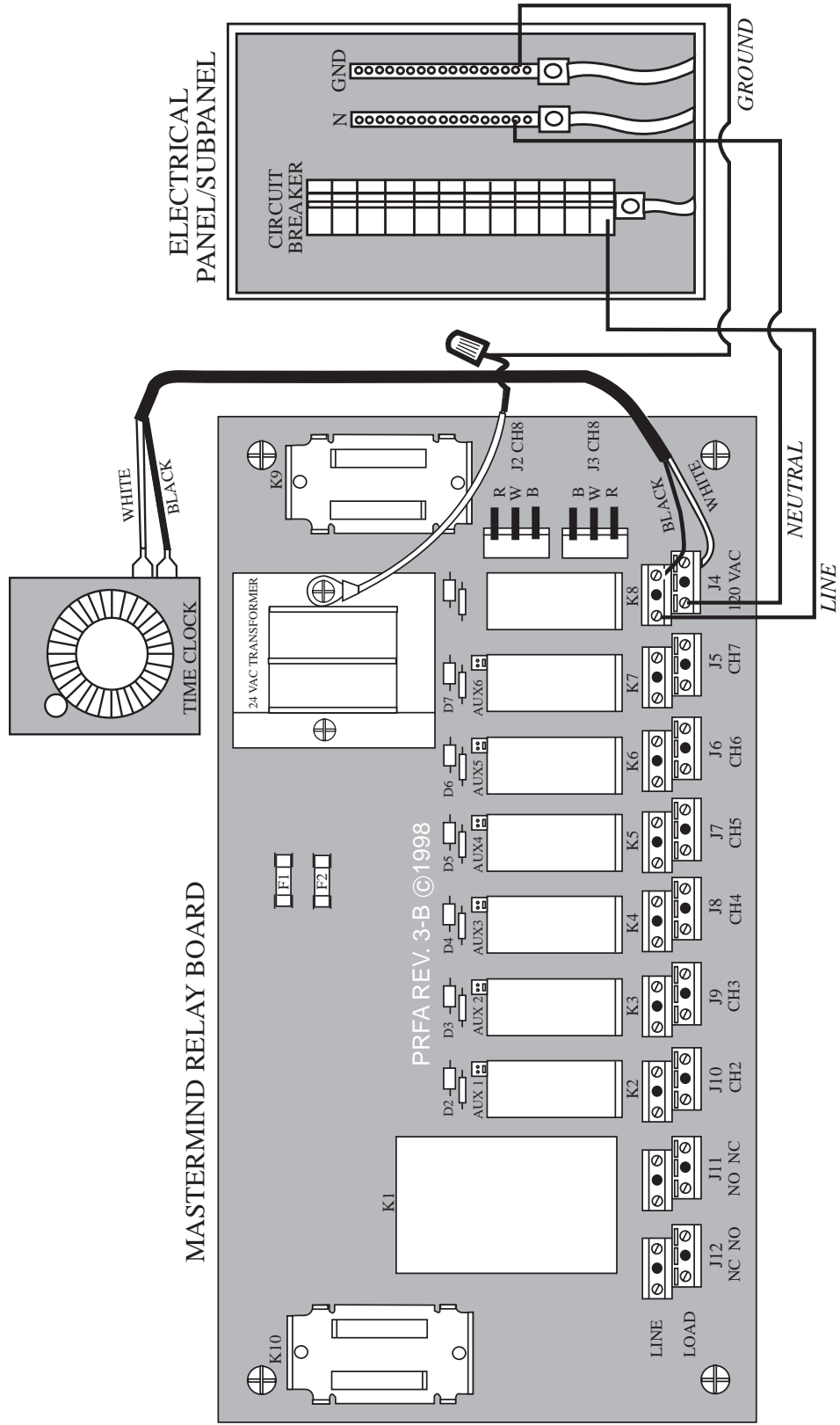

## 7. WIRING INSTRUCTIONS (Relays & Terminal Blocks)

Figure 4 below is a schematic representation of the relays and terminal blocks inside your MasterMind™ System Control Box.

Relay K1 is a double-pole, double-throw relay. Relays K2 through K7 are double-pole, single-throw (DPST) normally open (NO) relays. Relay K8 is a double-pole, double-throw (DPDT) relay. The relays are connected to the following terminal blocks:

Relay	K1	K2	K3	K4	K5	K6	K7	K8
Terminal Block	J12 & J11	J10	J9	J8	J7	J6	J5	J2 & J3

All 4-channel MasterMind™ Systems (MM-4) use relays K1, K2, K3, and the option of either K4 or K8. The fourth relay is factory-connected at the K8 position to control electric valve actuators (3 maximum) in the system. If there are no electric valve actuators, you may move the relay from the K8 position to the K4 position to connect some other 110V/220V pool component or accessory. All 8-channel MasterMind™ Systems (MM-8) use all relays K1 through K8.

The K8 relay is powered with 24 VAC @ 60 Hz through the transformer on the relay board. The J2 and J3 terminal blocks are three position terminal blocks, and both are connected to the K8 relay. Each will each control up to 3 electric valve actuators.

Relay K1 is UL rated at 20 amps, 1.0 hp @ 110 VAC, or 2.0 hp @ 220 VAC. Relays K2 through K8 are UL rated at 8 amps, 0.50 hp @ 110 V, or 1.0 hp @ 220 V.

# Relays & Terminal Blocks (Schematic)

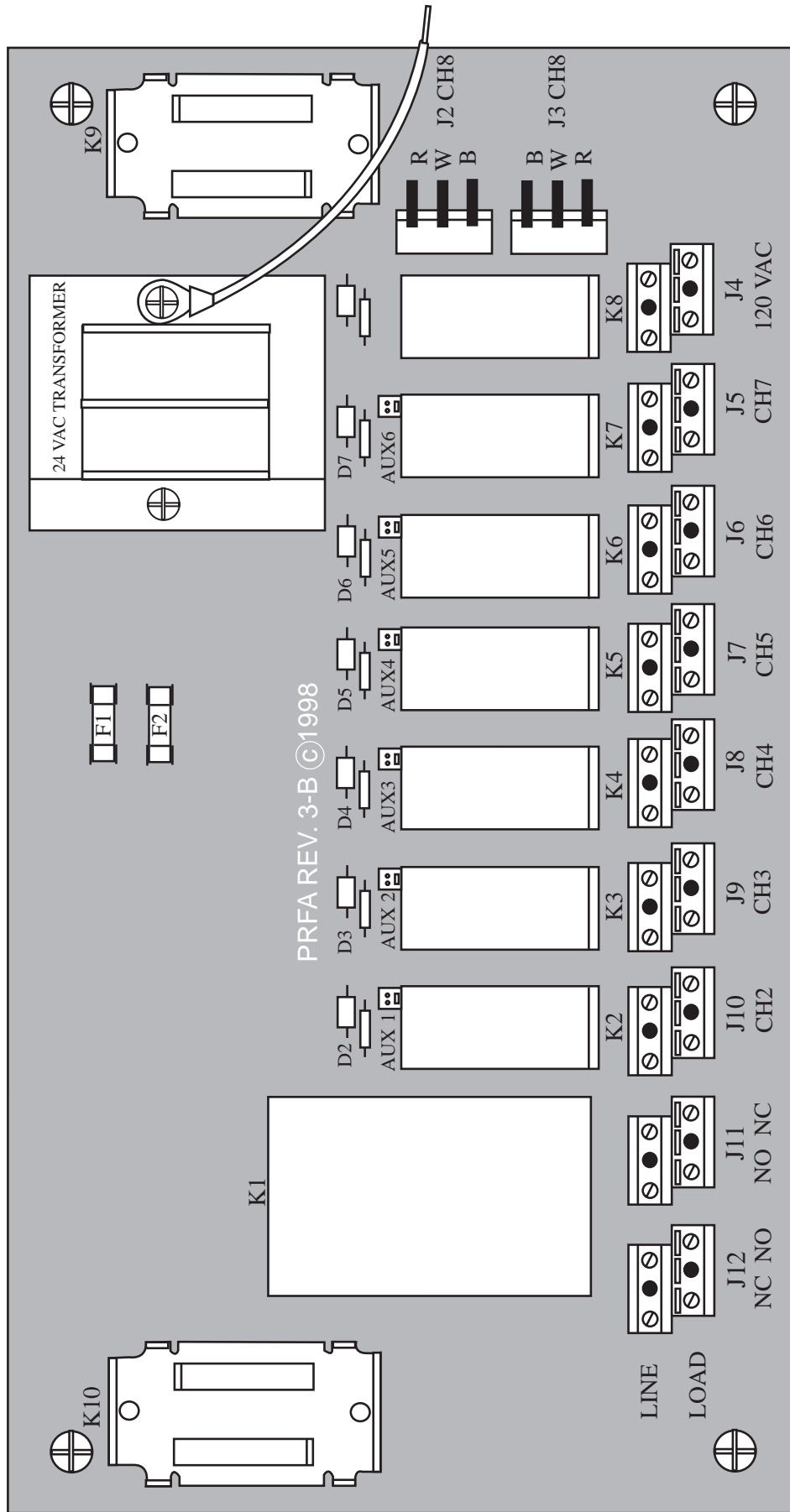

## 7.1 Relay K1 (Single-Speed, Primary Pump Relay Wiring)

1.  Before installation, be certain that the power supply to all electrical connections or applicable circuit breakers is shut “OFF” to avoid risk of electrical shock and injury.

2. **Terminal blocks J11 and J12** are reserved for the primary pump relay (K1) and are located on the far left-hand side of the relay board. For up to 1HP, 110V applications, use terminal block J12. For up to 2-HP, 220V applications, use both J11 and J12.

**NOTES:** (a) The pre-installed time clock is factory connected to control relay **K1**. It will turn the primary pump “on/off” every day at the specific times selected by the homeowner.  
(b) The time clock will **NOT** override an “ON” command from the remote control. For example, the time clock typically turns on the pump each day for its normal filter cycle. If, during that time, someone uses the remote control to turn the pump “ON” during that filter cycle, then, at the end of the normal time clock cycle, the pump will remain “ON” until turned off by the remote control. Similarly, when the pump is running during its normal time clock cycle, you cannot turn the pump “OFF” with the remote control.  
(c) For 2-speed pump wiring, see step 7.5.

3. (For new installations, skip to next step!) If the MasterMind is being installed on an existing pool system, disconnect the pump LOAD wire(s) from the circuit breaker.

### *For 110 Volt Applications*

4a. Bring a wire from the pump circuit breaker and connect it to the **top, right-hand side** (LINE connection) of **terminal block J12**. This side of the terminal block is also the column marked **NO (normally open)**. Tighten screw and make sure wire is secure.

5a. Bring a wire from the pump and connect it to the **bottom, right-hand side** (LOAD connection) of **terminal block J12**. This side of the terminal block is also marked **NO (normally open)**. (Note: If this is an existing pool system, this is the pump LOAD wire you disconnected in step 3.) Tighten screw and make sure wire is secure.

6a. Complete pump wiring by connecting a neutral wire (white) and a ground wire (green) between the pump and the neutral and ground connections in the electrical panel/sub-panel. (On existing systems, be sure that these connections have already been made.)

7a. **Note: You may combine multiple “pumps/accessories” on the same channel, using the same terminal blocks, as long as the total electrical current does not exceed 20 amps and 1 hp per pole. (Multiple wires may exceed capacity of the terminal block. Connect multiple wires with a wire nut and a single lead from the terminal block.)**

# For 110 Volt Applications

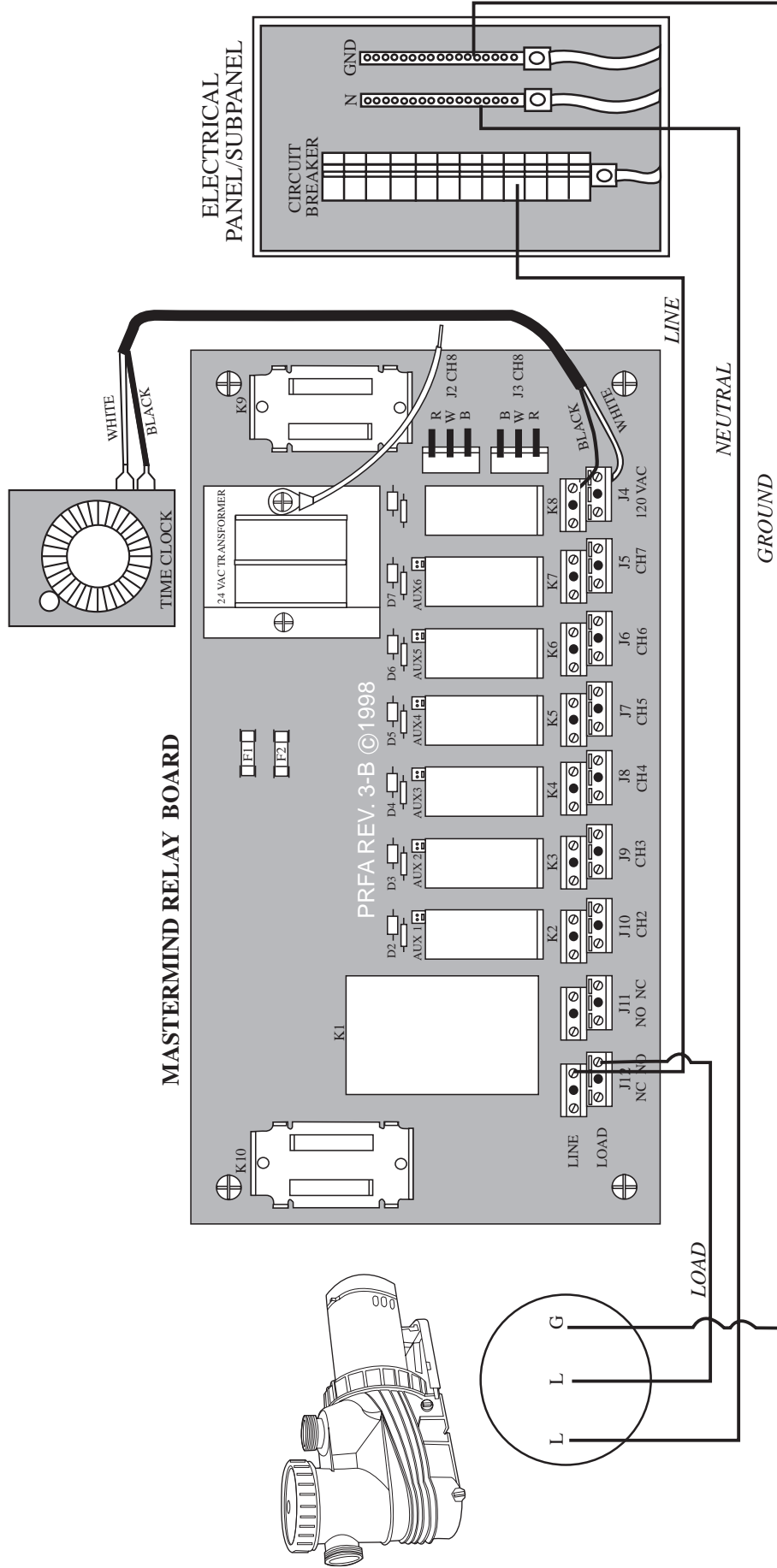

## *For 220 Volt Applications*

- 4b.** Bring two wires from the pump circuit breaker and connect one to the **top, right-hand side** (LINE connection) of **terminal block J12** and one to the **top, left-hand side** (LINE connection) of **terminal block J11**. Both of these connection points should be in the column marked **NO (normally open)**. Tighten screws and make sure wires are secure.
- 5b.** Bring two wires from the pump and connect one to the **bottom, right-hand side** (LOAD connection) of **terminal block J12** and one to the **bottom, left-hand side** (LOAD connection) of **terminal block J11**. Both of these connection points should also be in the column marked **NO (normally open)**. (Note: If this is an existing pool system, these are the pump LOAD wires you disconnected in step 3.) Tighten screws and make sure wires are secure.
- 6b.** Complete pump wiring by connecting a ground wire (green) between the pump and the ground connection in the electrical panel/sub-panel. (On existing systems, be sure that this connection has already been made.)
- 7b.** **Note: You may combine multiple “pumps/accessories” on the same channel, using the same terminal block connections, as long as the total electrical current does not exceed 20 amps and total horsepower does not exceed 2 hp. (Multiple wires may exceed capacity of the terminal block. Connect multiple wires with a wire nut and a single lead from the terminal block. Maximum 12 gauge wire.)**



## 7.2 Relay K2 Through K7

1.

 Before installation, be certain that the power supply to all electrical connections or applicable circuit breakers is shut **“OFF”** to avoid risk of electrical shock and injury.

2.

**Terminal blocks J5 through J10** are the wiring connections for your other pool/spa components or accessories that will be controlled by channels 2 through 7. For up to 8 amps, 1/2 HP, 110V applications, you will wire only one side of the specific terminal block(s). For up to 8 amps, 1 HP, 220V applications, you will wire both sides of the specific terminal block(s).

3.

**(For new installations, skip to next step!)** If the MasterMind is being installed on an existing pool system, disconnect the “component/accessory” LOAD wire(s) from the circuit breaker(s).

### *For 110 Volt Applications*

4a.

Bring a wire from the specific “component/accessory” circuit breaker and connect it to either slot on the **top row** (LINE connection) of the terminal block that corresponds to the channel you wish to control. Tighten screw and make sure wire is secure.

5a.

Bring a wire from the specific “component/accessory” and connect it to the **bottom slot** (LOAD connection) on the **same side** of the terminal block as made in step 4a above. (Note: If this is an existing pool system, this is the “component/accessory” LOAD wire you disconnected in step 3.) Tighten the screw and make sure wire is secure.

6a.

Complete “component/accessory” wiring by connecting a neutral wire (white) and a ground wire (green) between the “component/accessory” and the neutral and ground connections in the electrical panel/sub-panel. (On existing systems, be sure that these connections have already been made.)

**NOTE: You may combine multiple “components/accessories” on the same channel, using the same terminal block, as long as the total electrical current does not exceed 8 amps and 1/2 hp per pole. (Multiple wires may exceed capacity of the terminal block. Connect multiple wires with a wire nut and a single lead from the terminal block.)**



# For 110 Volt Applications

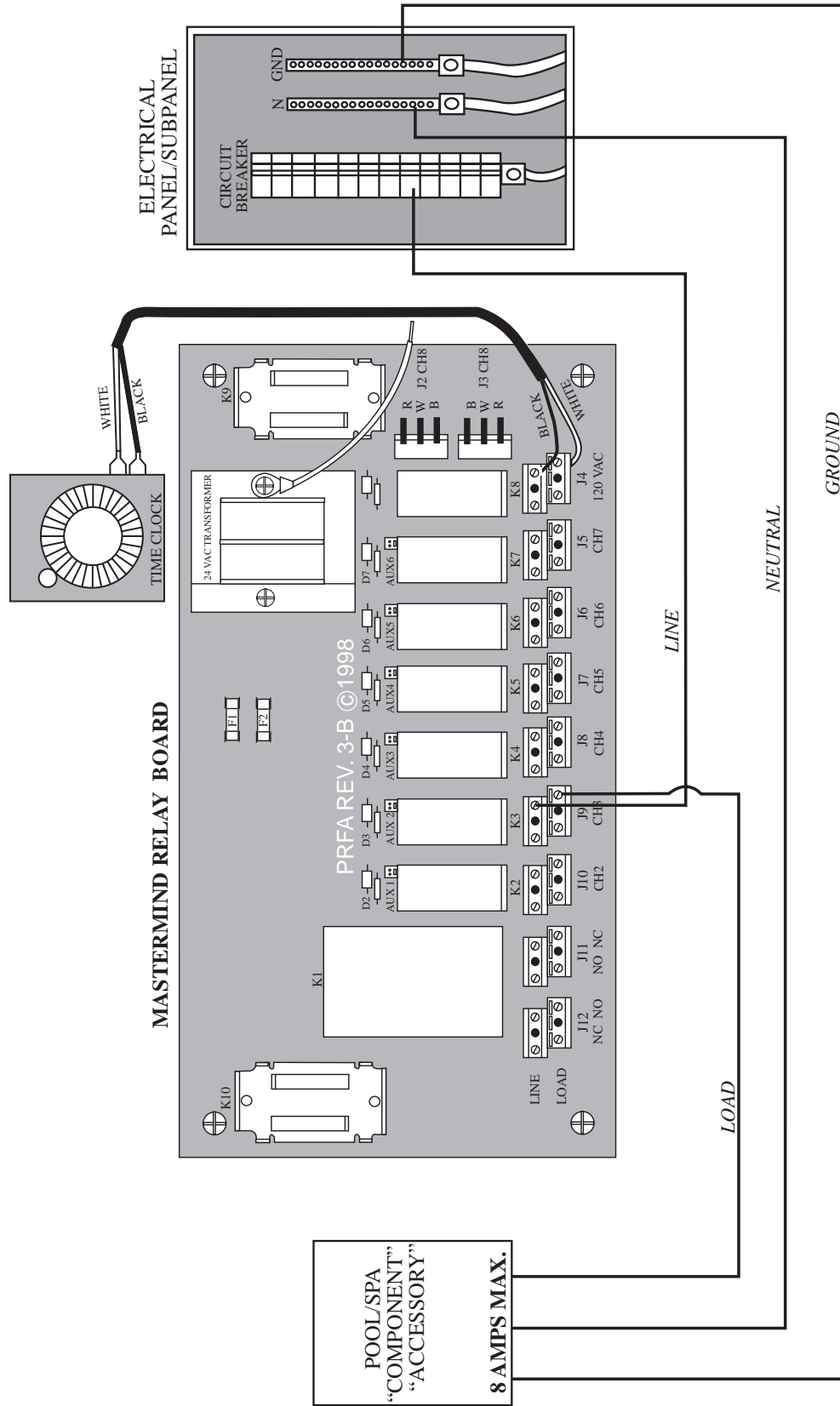

## *For 220 Volt Applications*

Bring two wires from the “component/accessory” circuit breaker and connect them to the **top two slots** (LINE connection) of the terminal block that corresponds to the Channel you wish to control. Tighten screws and make sure wires are secure.

Bring two wires from the “component/accessory” and connect them to the **bottom two slots** (LOAD connection) of the same terminal block. (Note: If this is an existing pool system, these are the “component/accessory” LOAD wires you disconnected in step 3.) Tighten screws and make sure wires are secure.

Complete “component/accessory” wiring by connecting a ground wire (green) between the “component/accessory” and the ground connection in the electrical panel/sub-panel. (On existing systems, be sure that this connections has already been made.)

**Note: You may combine multiple “components/accessories” on the same channel, using the same terminal block connections, as long as the total electrical current does not exceed 8 amps and total horsepower does not exceed 1HP. (Multiple wires may exceed capacity of the terminal block. Connect multiple wires with a wire nut and a single lead from the terminal block.)**

# For 220 Volt Applications

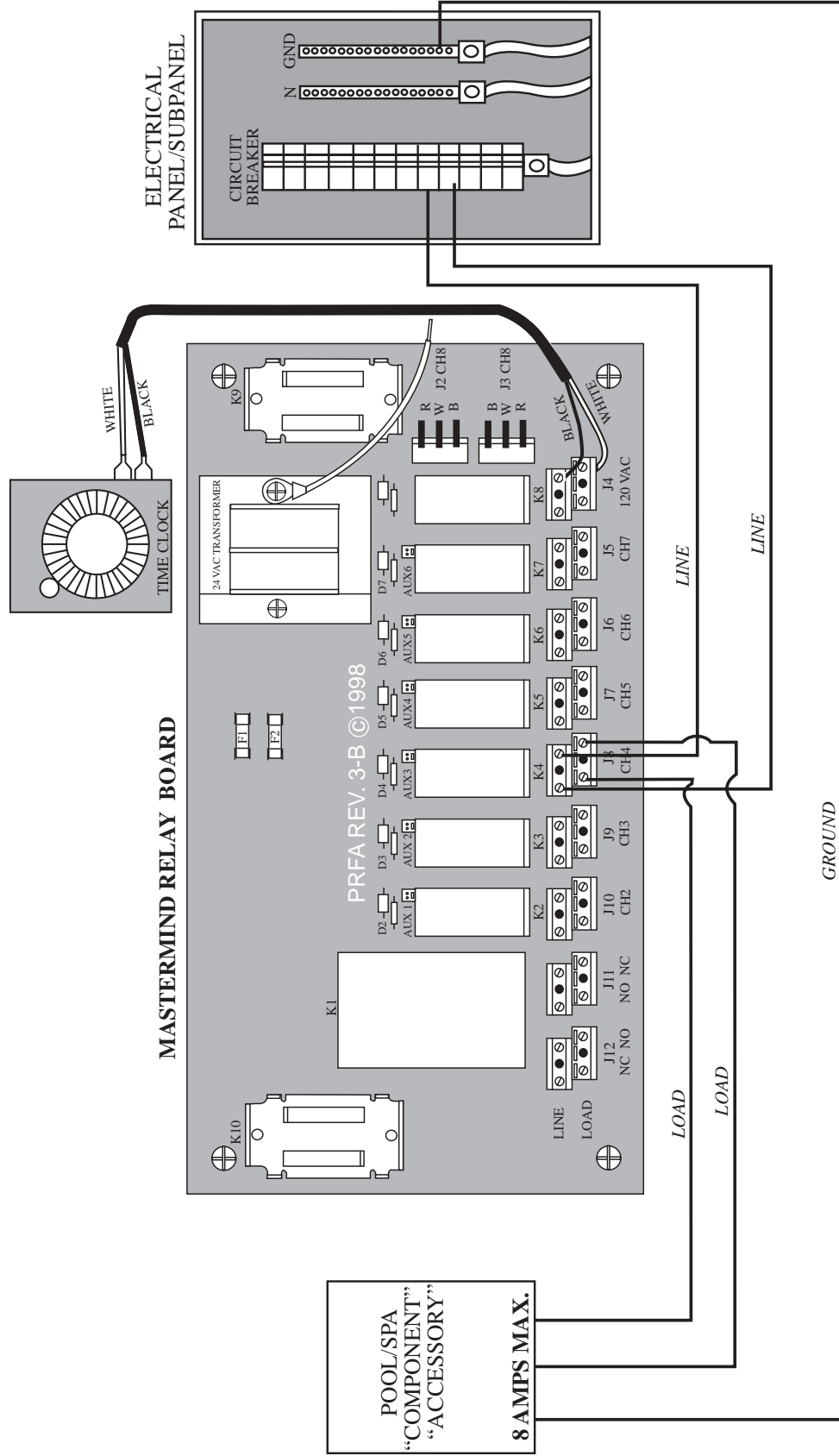

## 7.3 Relay K8 (Electric Valve Actuators)

1.  Before installation, be certain that the power supply to all electrical connections or applicable circuit breakers is shut “OFF” to avoid risk of electrical shock and injury.
2. Install the Jacuzzi ValveMinder electric valve actuators (if applicable) according to the instruction manual included with the valve actuators.
3. Bring the 3-conductor wire from the ValveMinder (factory-wired) to the MasterMind control box. Cut off the 3-pin connector (if supplied at the end of the wire.) Strip the ends of the wire to approximately 3/8 inch.
4. Use terminal blocks J2 and J3 to connect your valve actuators (3 maximum). Both J2 and J3 have 3 slots each that are identified by B (black), W (white), and R (red). Lift the black tabs on the terminal block. Insert the black wire from the valve actuator into the B (black) slot on the side of the terminal block. Match the white and red wires with the W (white) and R (red) slots on the side of the terminal block. Push the tabs down to lock the wires in place. Tug wires to be sure they are secure.
5. If you use 3 valve actuators, combine two (2) of the actuators in either the J2 or the J3 terminal block as shown.

# System Power Wiring Diagram

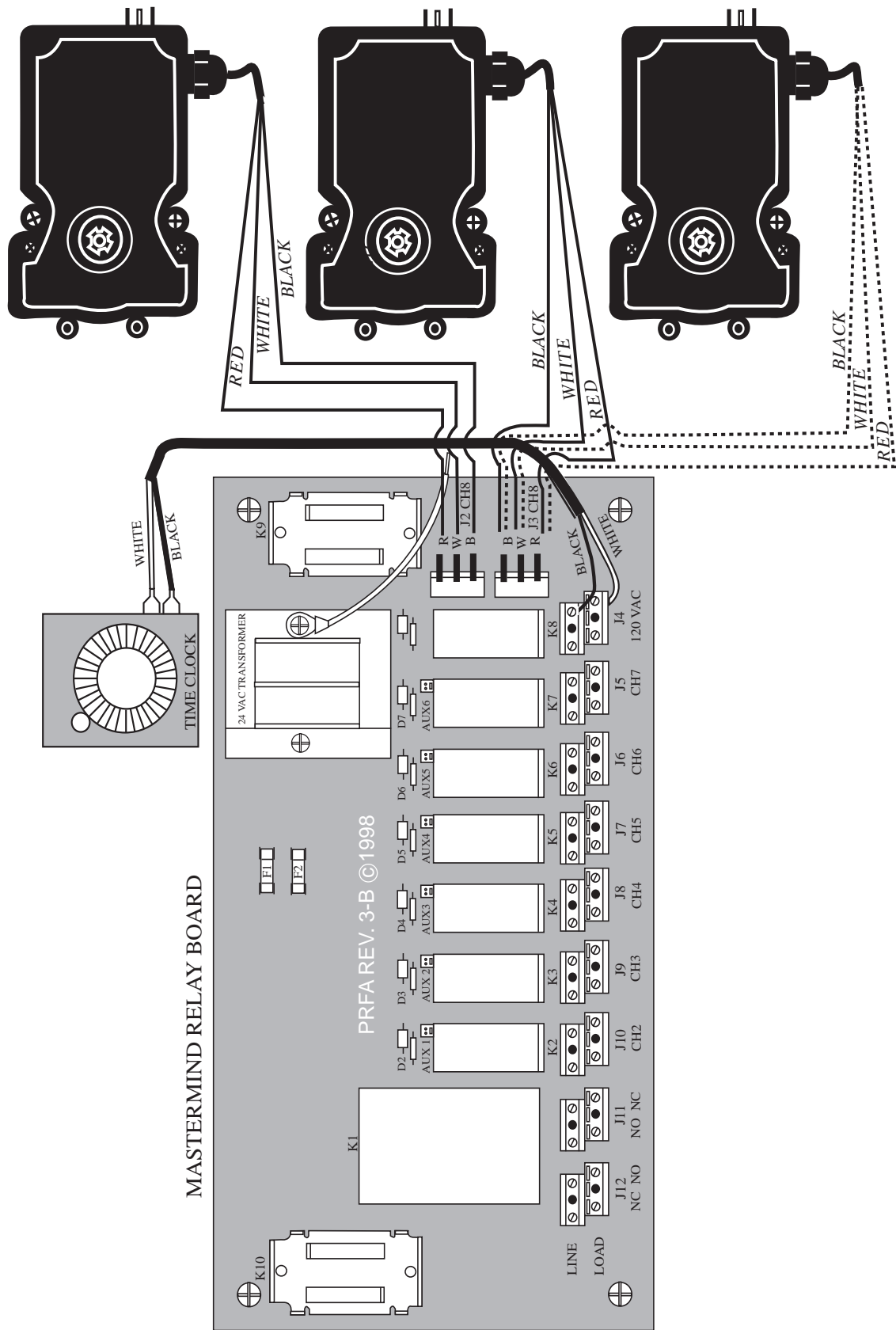

## 7.4 Optional Relay Positions K9 & K10 (Max 20 amp, 3 hp)

### 7.4.a Alternate Control for Channels 2 Through 7

In this application, an optional double pole, single throw (DPST) relay with a 12 volt coil (Part # 9194-5253) that allows you to connect to any of Channels 2-7 to control an additional pump, component, or accessory with contact ratings of 20 amps; 1.5 HP, 110 Volts; 3 HP, 220 Volts. **(WARNING! Before using this relay, you must first unplug and remove the factory-installed 8 amp relay located at the Channel you wish to use for this application.)**

1.  Before installation, be certain that the power supply to all electrical connections or applicable circuit breakers is shut **“OFF”** to avoid risk of electrical shock and injury.
2. Two metal brackets on the upper right and left hand corners of the relay board identify the locations for optional relays K9 and K10. Using the optional 20-amp relay with the 12 volt coil (Part number 9194-5253), snap it into either relay bracket K9 or K10 on the relay board. **WARNING! If an optional relay is installed in position K9, you must separate the high voltage field wiring connecting to the optional relay from any class 3, low voltage wiring connecting at terminal blocks J2 or J3 in accordance with Article 725 of the National Electrical Code. WARNING! The preassembled wires MUST face the inside of the control box and all wiring MUST be routed away from high-voltage terminal blocks J4 through J12.**
3. Plug in the factory-assembled, two-pin connector from the optional relay into the two-pin receptacle labelled AUX (1 through 6) that is directly above the relay that connects to the Channel (2 through 7) you wish to control. **(WARNING! You must unplug and remove the factory-installed 8 amp relay at this channel...e.g. relay K3 for Channel 3.)** Be sure to route wires away from high voltage terminal block J4 through J12.
4. **(For new installations, skip to next step!)** If the MasterMind is being installed on an existing pool system, disconnect the pump or component/accessory LOAD wire(s) from the circuit breaker.

### For 110 Volt Applications

- 5a. Bring a wire from the pump or component/accessory circuit breaker and connect it to **terminal 4** of the optional 20-amp relay. Tighten screw and make sure wire is secure.
- 6a. Bring a wire from the pump or component/accessory and connect it to **terminal 2** of the optional 20-amp relay. (Note: If this is an existing pool system, this is the pump or “component/accessory” LOAD wire you disconnected in step 4.) Tighten screws and make sure wire is secure.
- 7a. Complete pump wiring by connecting a neutral wire (white) and a ground wire (green) between the pump or component/accessory and the neutral and ground connections in the electrical panel/sub-panel. (On existing systems, be sure that these connections have already been made.)
- 8a. **NOTE: You may combine multiple pumps or “components/accessories” on the same channel, using the same relay connections, as long as the total electrical current does not exceed 20 amps and total horsepower does not exceed 1-1/2 HP, 110 volts; 3 HP, 220 volts. (Multiple wires may exceed capacity of the relay connection. Connect multiple wires with a wire nut and a single lead from the relay.)**



## *For 220 Volt Applications*

- 5b.** Bring two wires from the pump or component/accessory circuit breaker and connect one to **terminal 4** and one to **terminal 8** of the optional 20-amp pump relay. Tighten screws and make sure wires are secure.
- 6b.** Bring two wires from the pump or “component/accessory” and connect one to **terminal 2** and one to **terminal 6** on the optional 20 amp relay. (Note: If this is an existing pool system, these are the pump or “component/accessory” LOAD wires you disconnected in step 4.) Tighten screws and make sure wires are secure.
- 7b.** Complete pump or “component/accessory” wiring by connecting a ground wire (green) between the pump or “component/accessory” and the ground connection in the electrical panel/sub-panel. (On existing systems, be sure that this connection has already been made.)
- 8b.** **Note: You may combine multiple pumps or “components/accessories” on the same channel, using the same relay connections, as long as the total electrical current does not exceed 20 amps and total horsepower does not exceed 1 HP, 110 volts; 3 HP, 220 volts. (Multiple wires may exceed capacity of the relay connection. Connect multiple wires with a wire nut and a single lead from the relay.)**



# For 220 Volt Applications

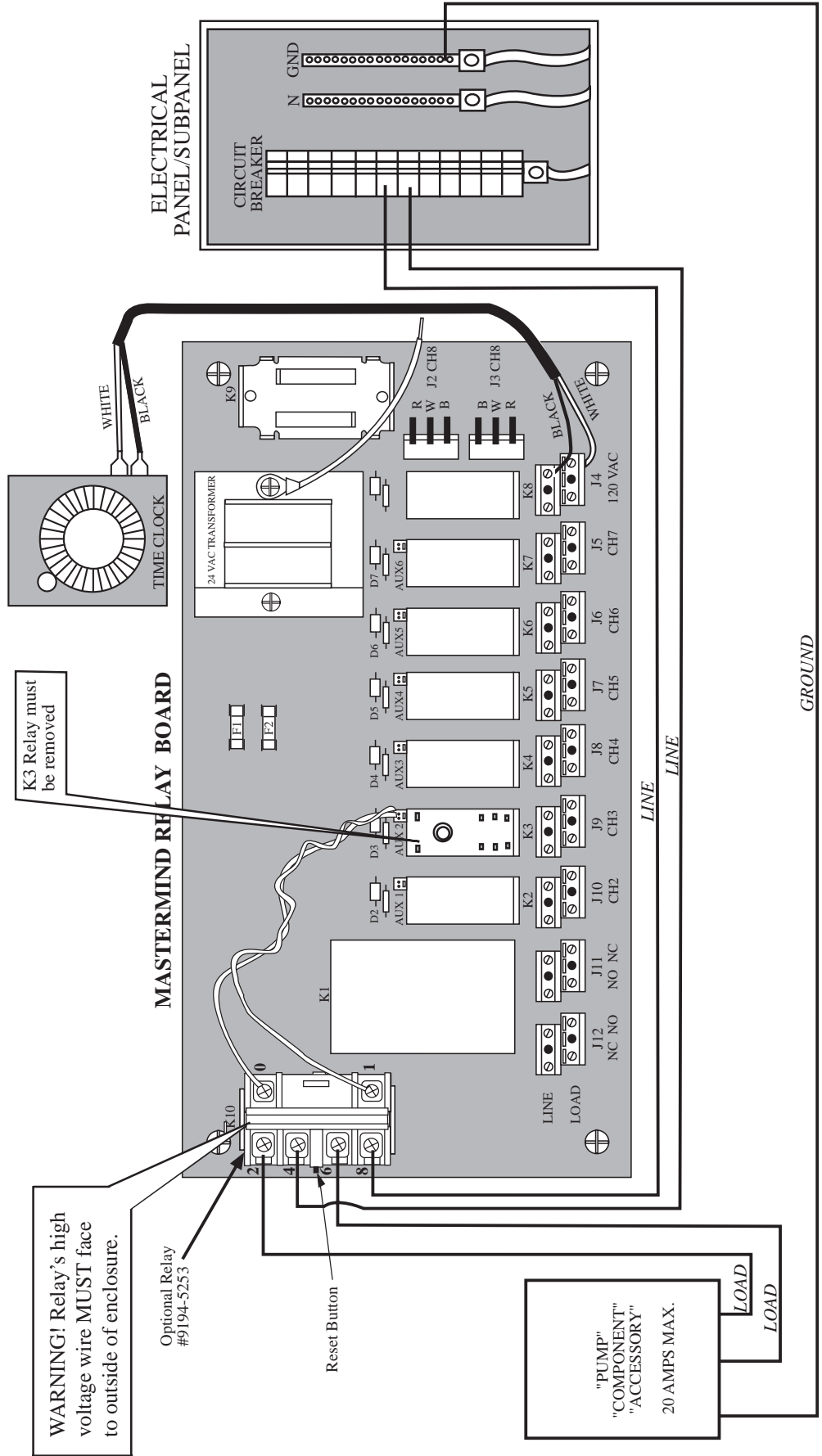

## 7.4 Optional Relay Positions K9 & K10 (Max 20 amp, 3 hp) cont'd

### 7.4.b Alternate Control for Channel 8

In this application, an optional pole, single throw (DPST) 30 amp relay with a 24 volt coil (Part #9194-5394) that allows you to connect to Channel 8 to control an additional pump, component, or accessory with maximum contact ratings of 20 amps; 1.5 HP, 110 Volts; 3 HP, 220 Volts. **(This relay allows you to utilize Channel 8 only when there are NO electric valve actuators in the system.)**

1.  Before installation, be certain that the power supply to all electrical connections or applicable circuit breakers is shut “OFF” to avoid risk of electrical shock and injury.
2. Using the optional 20-amp relay with the 24 volt coil (Part number 9194-5394), snap it into either relay bracket K9 or K10 on the relay board. **WARNING! If an optional relay is installed in position K9, you must separate the high voltage field wiring connecting to the optional relay from any class 3, low voltage wiring connecting at terminal blocks J2 or J3 in accordance with Article 725 of the National Electrical Code. WARNING! The preassembled wires MUST face the inside of the control box and all wiring MUST be routed away from high-voltage terminal blocks J4 through J12.**
3. Identify the black and white wires that come factory-installed with this optional relay. These wires will connect to either terminal block J2 or J3 on the relay board. Lift the black tabs on the selected terminal block. Insert the black wire from the optional relay into the B (black) slot on the side of the terminal block. Insert the white wire from the optional relay into the W (white) slot on the side of the terminal block. Push the tabs down to lock the wires in place. Tug wires to be sure they are secure.

### For 110 Volt Applications

- 5a. Bring a wire from the pump or component/accessory circuit breaker and connect it to **terminal 4** of the optional 20-amp relay. Tighten screw and make sure wire is secure.
- 6a. Bring a wire from the pump or component/accessory and connect it to **terminal 2** of the optional 20-amp relay. (Note: If this is an existing pool system, this is the pump or “component/accessory” LOAD wire you disconnected in step 4.) Tighten screws and make sure wire is secure.
- 7a. Complete pump wiring by connecting a neutral wire (white) and a ground wire (green) between the pump or component/accessory and the neutral and ground connections in the electrical panel/sub-panel. (On existing systems, be sure that these connections have already been made.)

**NOTE: You may combine multiple pumps or “components/accessories” on the same channel, using the same relay connections, as long as the total electrical current does not exceed 20 amps and total horsepower does not exceed 1-1/2 HP, 110 volts; 3 HP, 220 volts. (Multiple wires may exceed capacity of the relay connection. Connect multiple wires with a wire nut and a single lead from the relay.)**

# For 110 Volt Applications

**WARNING!** High voltage field wiring must be separated from class 3 low voltage wiring connecting at terminal blocks J2 or J3 in accordance with Article 725 of National Electrical Code.

**WARNING!** Relay's high voltage wire **MUST** face to outside of enclosure.

OPTIONAL RELAY #9194-5394

## MASTERMIND RELAY BOARD

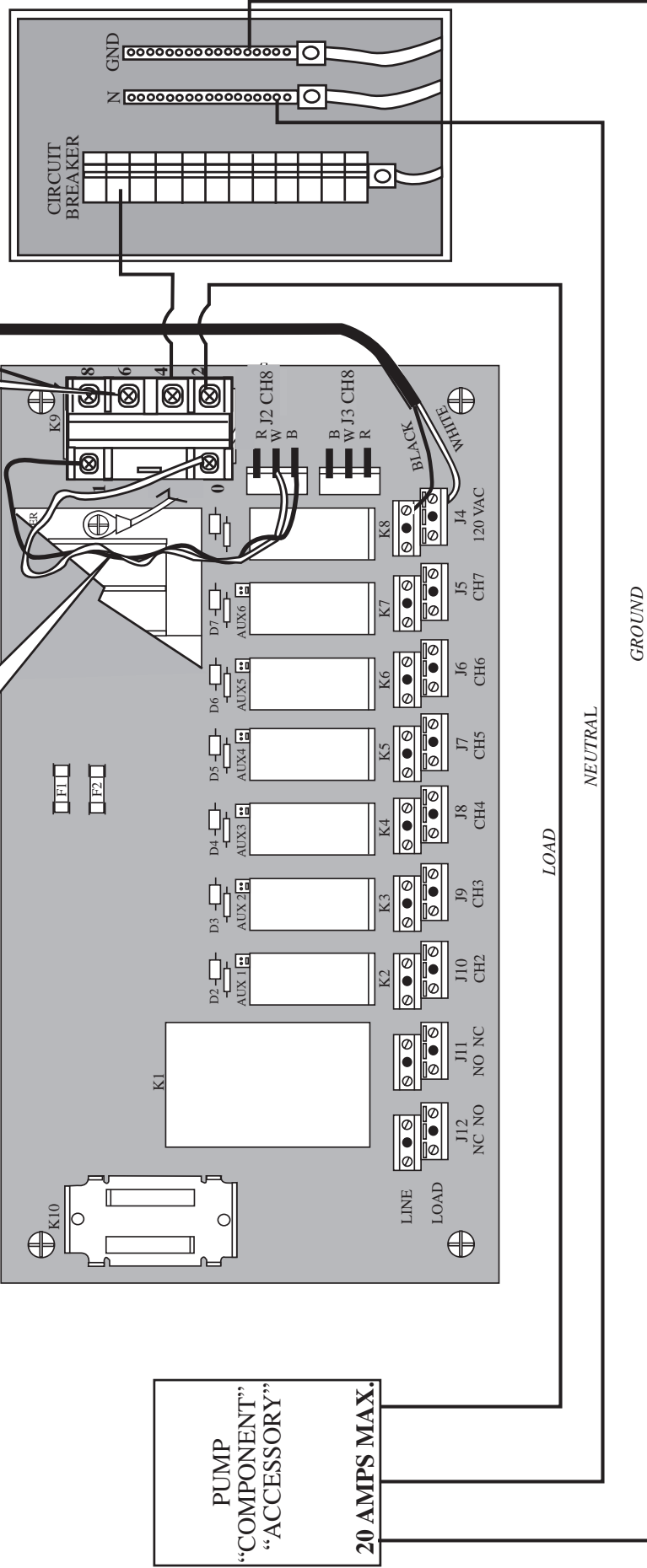

PUMP  
"COMPONENT"  
"ACCESSORY"  
**20 AMPS MAX.**

LOAD

NEUTRAL

GROUND

## *For 220 Volt Applications*

- 5b.** Bring two wires from the pump or component/accessory circuit breaker and connect one to **terminal 4** and one to **terminal 8** of the optional 20-amp pump relay. Tighten screws and make sure wires are secure.
- 6b.** Bring two wires from the pump or “component/accessory” and connect one to **terminal 2** and one to **terminal 6** on the optional 20 amp relay. (Note: If this is an existing pool system, these are the pump or “component/accessory” LOAD wires you disconnected in step 4.) Tighten screws and make sure wires are secure.
- 7b.** Complete pump or “component/accessory” wiring by connecting a ground wire (green) between the pump or “component/accessory” and the ground connection in the electrical panel/sub-panel. (On existing systems, be sure that this connection has already been made.)
- 8b.** **Note: You may combine multiple pumps or “components/accessories” on the same channel, using the same relay connections, as long as the total electrical current does not exceed 20 amps and total horsepower does not exceed 1 HP, 110 volts; 3 HP, 220 volts. (Multiple wires may exceed capacity of the relay connection. Connect multiple wires with a wire nut and a single lead from the relay.)**

# For 220 Volt Applications

**WARNING!** Relay's high voltage wire **MUST** face to outside of enclosure.

**WARNING!** High voltage field wiring must be separated from class 3 low voltage wiring connecting at terminal blocks J2 or J3 in accordance with Article 725 of National Electrical Code.

OPTIONAL RELAY #9194-5394

## MASTERMIND RELAY BOARD

## ELECTRICAL PANEL/SUBPANEL

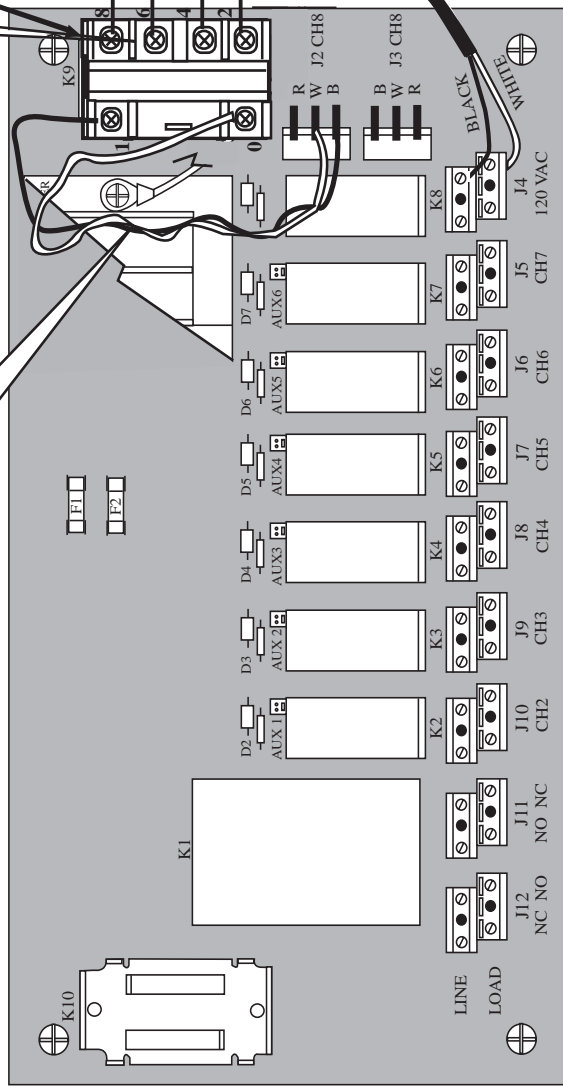
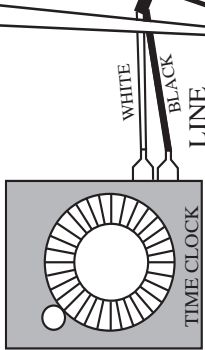
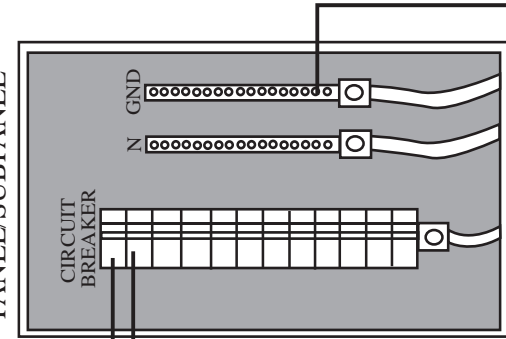

PUMP  
"COMPONENT"  
"ACCESSORY"  
**20 AMPS MAX.**

LOAD

LOAD

GROUND

## 7.5 Two-Speed Pump Wiring

2.  For two-speed pump applications, Channel 1 will control high and low speed, and Channel 2 will control “On/Off”.
3. Using the optional 20-amp pump relay (Part number 9194-5253), snap it into the relay bracket labelled K10 on the relay board. **WARNING! The preassembled wires MUST face the inside of the control box and all wiring MUST be routed away from high-voltage terminal blocks J4 through J12.**
4. Plug in the factory-assembled, two-pin connector from the optional 20-amp pump relay into the two-pin receptacle labelled AUX1 directly above relay K2 that controls Channel 2. (**WARNING! You must unplug and remove the factory-installed 8 amp relay K2.**) Be sure to route wires away from high voltage terminal block J4 through J12.
5. The pre-installed time clock is factory connected to control the “on/off” function of a single-speed pump wired to relay K1 (Channel 1). For 2-speed pump applications, the “on/off” function is controlled through Channel 2, and the time clock wiring must be changed to control Channel 2. Identify the red wire in the gray sleeve that runs from the time clock to the blue terminal block on the **radio receiver board mounted in the lid** of the MasterMind enclosure. Note that it is installed in the slot marked CH1. Remove the wire from CH1 and reconnect it in the slot marked CH2 (include with other wires already included). The time clock will now control Channel 2. Tighten screws and tug wire to make certain it is secure.
6. (**For new installations, skip to next step!**) If the MasterMind is being installed on an existing pool system, disconnect the pump LOAD wire(s) from the circuit breaker and the high and low speed pump wires from the existing 2-speed controller/switch.

### For 110 Volt Applications

- 7a. Bring a wire from the pump circuit breaker and connect it to **terminal 4** of the optional 20-amp pump relay. Tighten screw and make sure wire is secure.
- 8a. Connect a wire from **terminal 2** of the optional 20-amp relay to the **top, left-hand side** (LINE connection) of **terminal block J12**. This side of the terminal block is also marked NC (Normally Closed). Tighten screws and make sure wire is secure.
- 9a. Bring a wire from the low-speed connection at the pump and connect it to the **bottom, left-hand side** (LOAD connection) of terminal block J12. This side of the terminal block is also marked NC (Normally Closed). (Note: If this is an existing pool system, this is the low-speed pump wire you disconnected in step 5.) Tighten screw and make sure wire is secure.
- 10a. Bring a wire from the high-speed connection at the pump and connect it to the **bottom, right-hand side** (LOAD connection) of **terminal block J12**. This side of the terminal block is also marked NO (Normally Open). (Note: If this is an existing pool system, this is the high-speed pump wire you disconnected in step 5.) Tighten screw and make sure wire is secure.
- 11a. Complete pump wiring by connecting a neutral wire (white) and a ground wire (green) between the pump and the neutral and ground connections in the electrical panel/sub-panel. (On existing systems, be sure that these connections have already been made.)

# For 110 Volt Applications

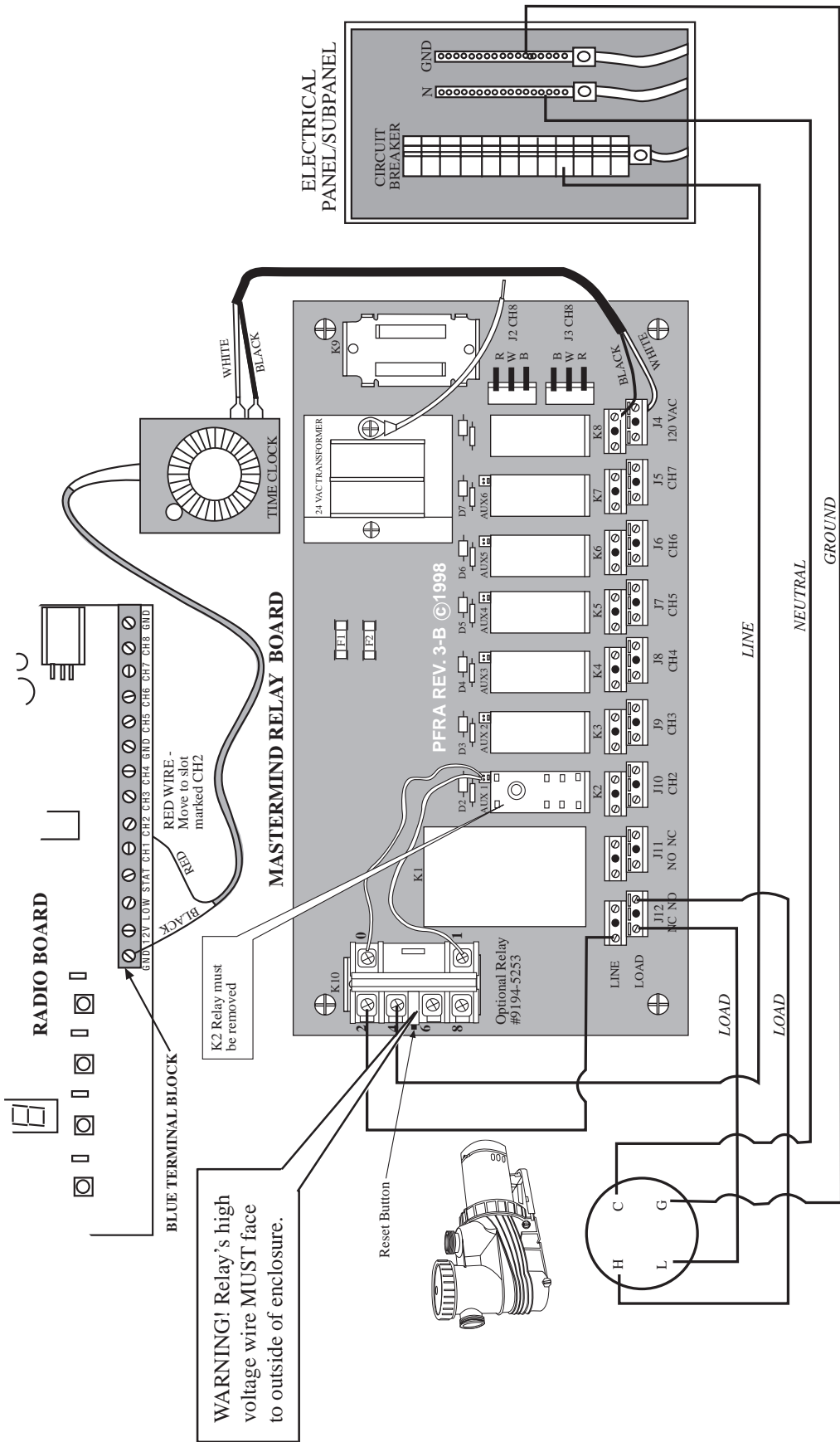

## *For 220 Volt Applications*

- 7b.* Bring two wires from the pump circuit breaker and connect one to **terminal 4** and one to **terminal 8** of the optional 20-amp pump relay. Tighten screws and make sure wires are secure.
- 8b.* Connect a wire from **terminal 2** of the optional 20-amp relay to the **top, left-hand side** (LINE connection) of terminal block J12. Tighten screws and make sure wire is secure.
- 9b.* Connect a wire from **terminal 6** of the optional 20-amp relay to the COMMON connection at the pump. Tighten screws and make sure wire is secure.
- 10b.* Bring a wire from the low-speed connection at the pump and connect it to the **bottom, left-hand side** (LOAD connection) of **terminal block J12**. This side of the terminal block is also marked NC (Normally Closed). (Note: If this is an existing pool system, this is the low-speed pump wire you disconnected in step 5.) Tighten screw and make sure wire is secure.
- 11b.* Bring a wire from the high-speed connection at the pump and connect it to the **bottom, right-hand side** (LOAD connection) of **terminal block J12**. This side of the terminal block is also marked NO (Normally Open). (Note: If this is an existing pool system, this is the high-speed pump wire you disconnected in step 5.) Tighten screw and make sure wire is secure.
- 12b.* Complete pump wiring by connecting a ground wire (green) between the pump and the ground connection in the electrical panel/sub-panel. (On existing systems, be sure that this connection has already been made.)



# For 220 Volt Applications

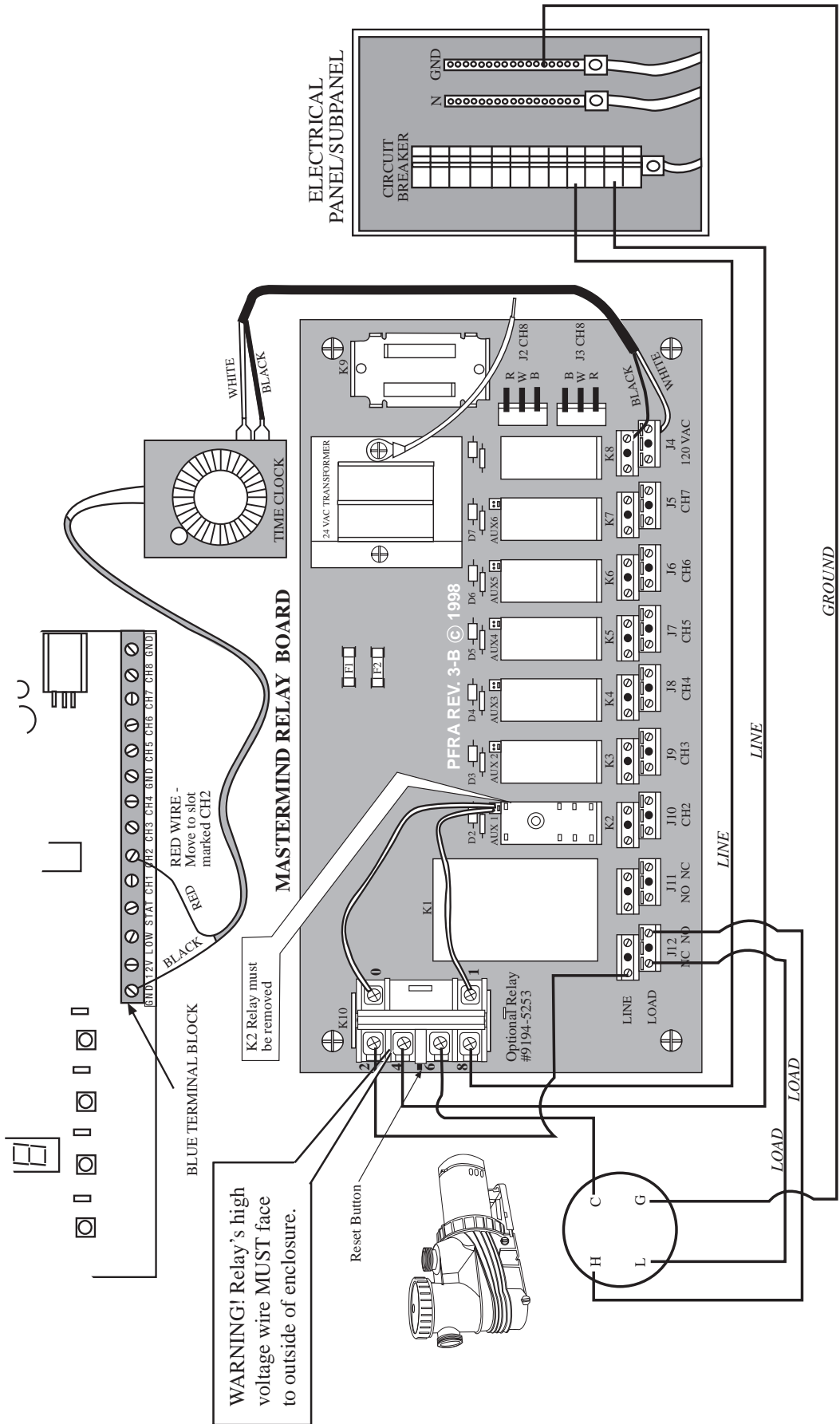

## 7.6 Wiring Additional Time Clocks

1. Before installation, be certain that the power supply to all electrical connections or applicable circuit breakers is shut “OFF” to avoid risk of electrical shock and injury.
2. Using the two-sided tape included on the back of the time clock (PART # 9194-5345), install the clock in the MasterMind enclosure in a location that will not interfere with lid closure, conduit, wiring, or any other components in the control box.
3. Identify the 14 AGW black and white wires in the black sleeve. These wires carry the 110 volt power supply to the clock and will connect at terminal block J4.
4. Connect the black wire to either slot in the **top row** (LINE connection) of **terminal block J4 (include with other wires already installed)**. Tighten screw and tug all wires to be sure they are secure.
5. Connect the white wire to either slot in the **bottom row** (Neutral connection) of **terminal block J4 (include with other wires already installed)**. Tighten screw and tug all wires to make sure they are secure.
6. Identify the remaining low-voltage black and red wires in the gray sleeve. These wires will connect the clock to the **blue terminal block** on the receiver board mounted in the lid of the MasterMind enclosure.
7. Loosen one of the three (3) screws on blue terminal block on receiver board marked GND (ground), one at each end and one in the middle. Insert the black, low-voltage wire from the time clock (include with other wires already installed). Tighten screw and tug wire(s) to make certain it is secure.
8. Determine which channel you wish to control with the additional time clock. Each channel is identified below a specific slot on the blue terminal block on the receiver board with the letters CH followed by the channel number (eg: CH6).
9. Loosen screw to the desired channel slot on blue terminal block on the receiver board. Insert the red, low-voltage wire from the time clock into the open slot (include with other wires already installed). Tighten screw and tug all wires to make sure they are secure.
10. **NOTE: The time clock will NOT override an “ON” command from the remote control. For example, the time clock typically turns on the pump each day for its normal filter cycle. If, during that time, someone uses the remote control to turn the pump “ON” during that filter cycle, then, at the end of the normal time clock cycle, the pump will remain “ON” until turned off by the remote control. Similarly, when the pump is running during its normal time clock cycle, you cannot turn the pump “OFF” with the remote control.**

# Additional Time Clock Wiring Diagram

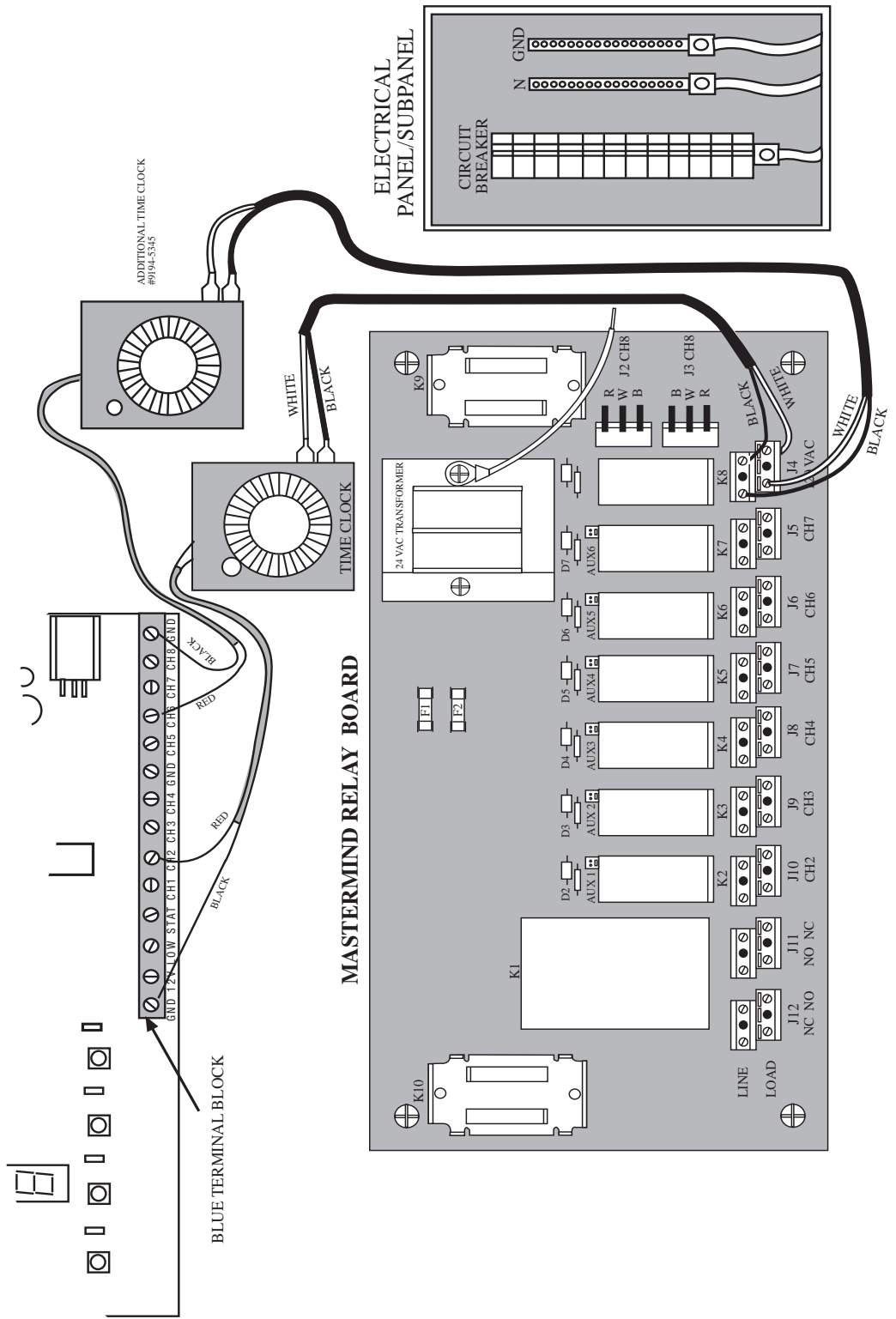

## 7.7 Automatic Freeze Protection Wiring

The Automatic Freeze Protector (#9194-5410) controls the “ON/OFF” relay connected to your primary circulation pump (typically K1 for single speed pumps; typically K2 for 2-speed pumps). When the ambient temperature surrounding the Automatic Freeze Protector drops to 35 degrees Fahrenheit, the pump will turn “ON” and continue running until the ambient temperature surrounding the Freeze Protector rises to 38 degrees Fahrenheit.

1. **!!!!** Before installation, be certain that the power supply to all electrical connections or applicable circuit breakers is shut “**OFF**” to avoid risk of electrical shock and injury.
2. The optional Automatic Freeze Protector is supplied with approximately 6 inches of 22 AWG 2-conductor wire. You may add up to 25 feet of additional 22 AWG 2-conductor wire to accommodate the best location for the Freeze Protector. It **must not** be placed within the enclosure. **NOTE: To keep MasterMind’s UL listing, no holes may be drilled through the enclosure above the location of the power terminal blocks mounted inside the unit as indicated in Figure B, page 5.**
3. The two wires supplied with the Automatic Freeze Protector will connect to the **blue terminal block** on the receiver board mounted in the lid of the MasterMind enclosure.
4. Loosen one of the three (3) screws on **blue terminal block** on receiver board marked **GND (ground)**, one at each end and one in the middle. Insert one of the wires from the Freeze Protector (include with other wires already installed). Tighten screw and tug wire(s) to make certain it is secure.
5. Determine which channel you wish to control with the optional Freeze Protector (typically Channel 1 for single speed pumps; typically Channel 2 for 2-speed pumps). Each channel is identified below a specific slot on the blue terminal block on the receiver board with the letters CH followed by the channel number (eg: CH1).
6. Loosen screw to the desired channel slot on blue terminal block on the receiver board. Insert the remaining wire from the Automatic Freeze Protector into the open slot (include with other wires already installed). Tighten screw and tug all wires to make sure they are secure.

# Automatic Freeze Protection Wiring Diagram

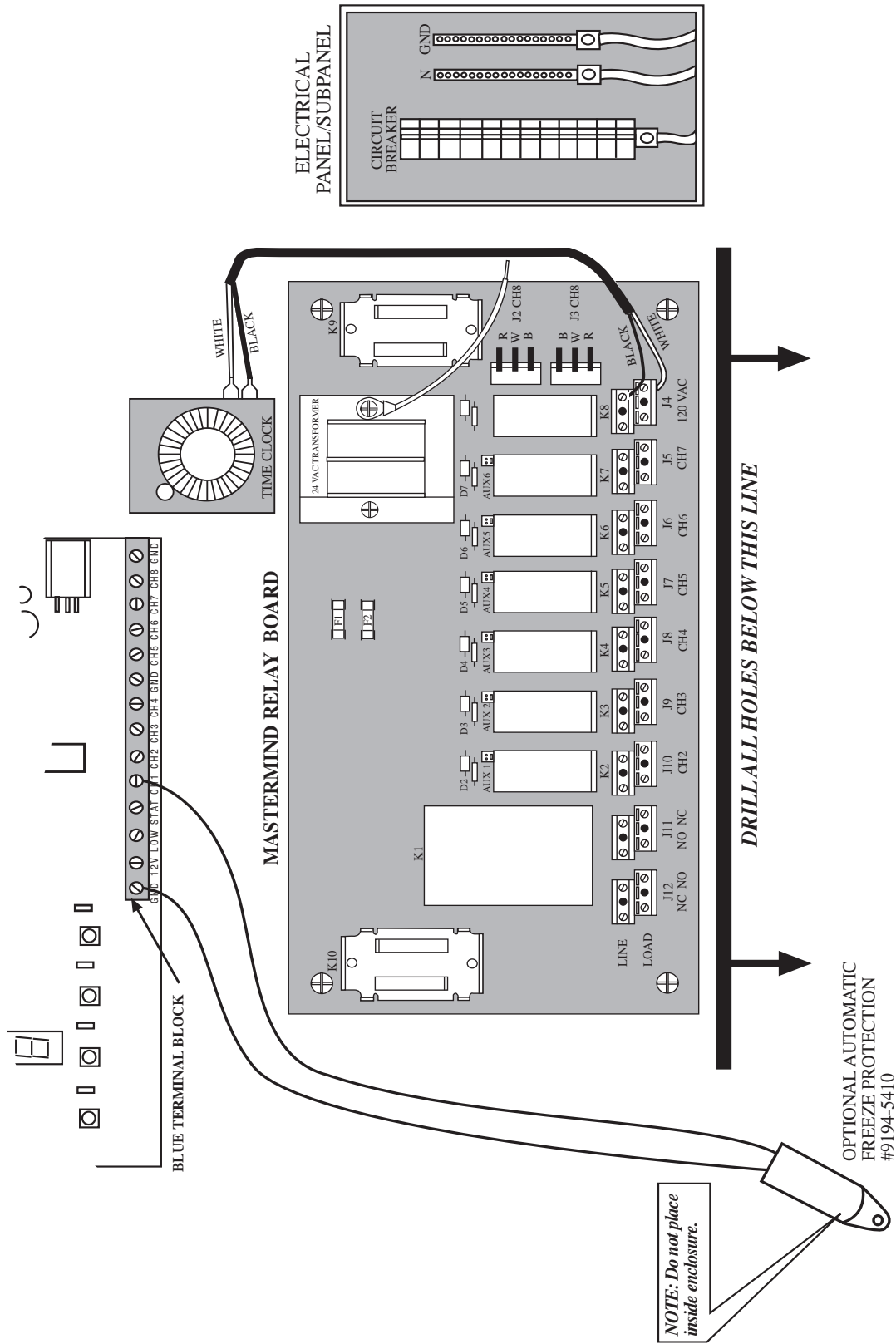

## 7.8 Heater Control (Single Thermostat “ON/OFF”)

Control of this function turns the heater thermostat “ON” or “OFF”. **It does not raise or lower the temperature that you set with the existing heater controls.**

1.  Before installation, be certain that the power supply to all electrical connections or applicable circuit breakers is shut “**OFF**” to avoid risk of electrical shock and injury.
2. You may control your heater “ON/OFF” on any one of Channels 2 through 7. **Terminal blocks J5 through J10** are the wiring connections for Channels 2 through 7.
3. Refer to your heater installation manual or wiring diagram to identify the heater “ON/OFF” control wire. Disconnect this wire and connect it to the **top row** (LINE connection) of the terminal block that corresponds to the Channel you wish to control. (e.g. J9 connecting Channel 3)
4. Connect a wire between the **bottom row** (LOAD connection) on the **same side** of the terminal block used in step 3 above and the location in the heater where the heater “ON/OFF” control wire was disconnected in step 3 above.

# Heater "ON/OFF" Wiring Diagram

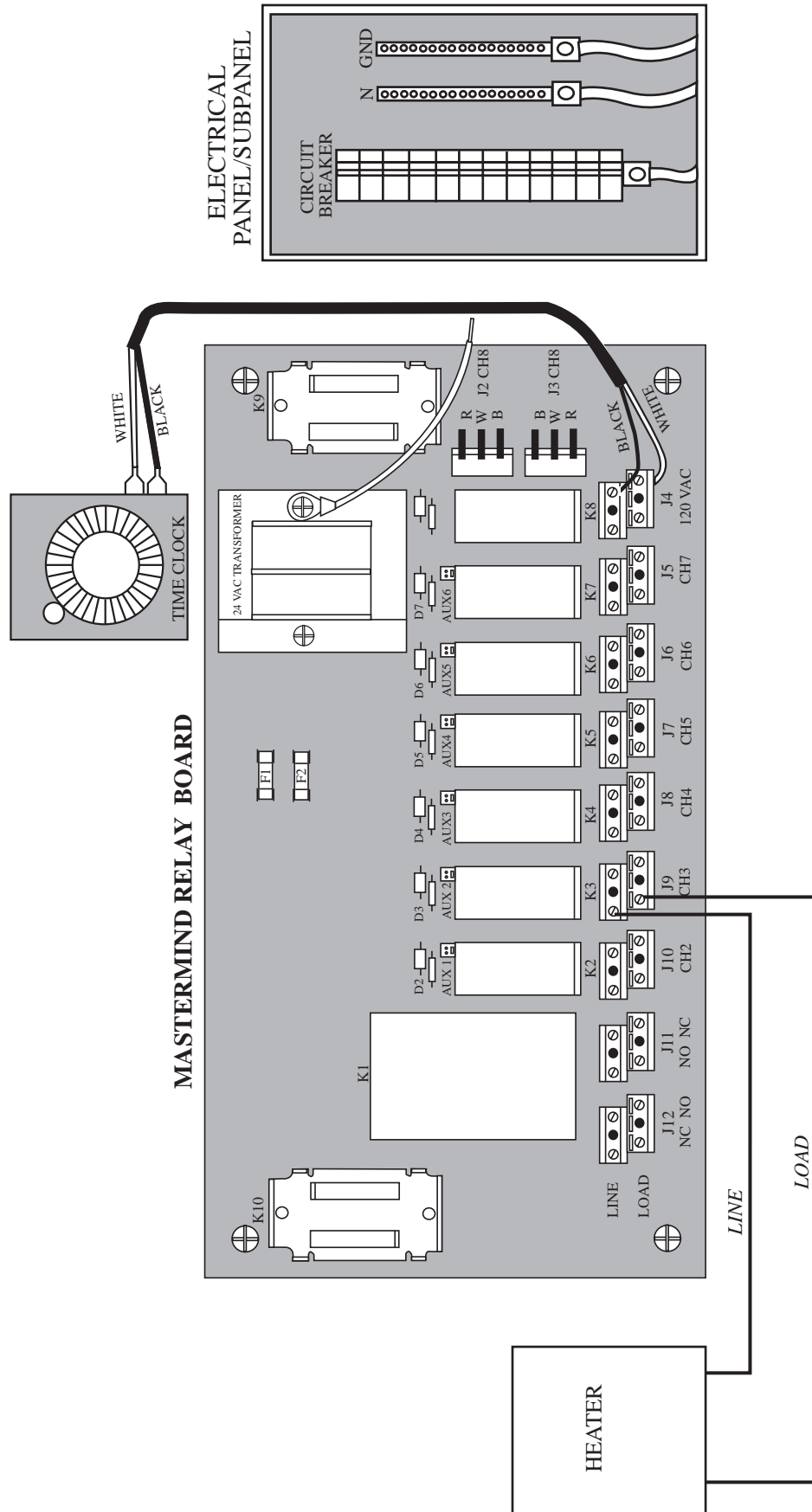

## 7.9 Heater Control (Switching Dual Thermostats)

In this application an optional single pole, double-throw (SPDT), 10 amp relay with a 12 volt coil (#9194-5428) allows you to shift control back and forth between the pool thermostat and the spa thermostat. **It does not raise or lower the temperatures that you set for each thermostat with the existing heater controls.**

1.  Before installation, be certain that the power supply to all electrical connections or applicable circuit breakers is shut **“OFF”** to avoid risk of electrical shock and injury.
2. You may control the dual thermostats on your heater on any one of Channels 2 through 7.
3. Using the optional 10-amp relay, mount it **above high voltage terminals J4-J12** in a location that does not interfere with lid closure, conduit, wiring, or any other components in the control box.
4. Plug in the factory-assembled, two-pin connector from the optional relay into the two-pin receptacle labelled AUX (1 through 6) that is directly above the relay that connects to the Channel (2 through 7) you wish to control (e.g. AUX 3 connecting Channel 4). **(WARNING! You must unplug and remove the factory-installed 8 amp relay located at the Channel you wish to use...e.g. relay K4 for Channel 4.)** Be sure to route wires away from high voltage terminal block J4 thru J12.
5. Refer to your heater installation manual or wiring diagram to identify the wire that controls the dual thermostats in your heater. Disconnect this wire and connect it to **terminal 4** on the optional 10-amp heater relay. Tighten screws and make certain wire is secure.
6. Connect a wire between **terminal 2** on the optional 10-amp relay and the **pool thermostat** wire in your heater. Tighten screws and make certain wire is secure.
7. Connect a wire between **terminal 3** on the optional 10-amp relay and the **spa thermostat** wire in your heater. Tighten screws and make certain wire is secure.





## JACUZZI LIMITED WARRANTY

Jacuzzi Bros. Division (JBD) warrants its products to be free of defects in material and workmanship for a period of 1 year from date of purchase or 3 years from date of manufacture, whichever comes first; Jacuzzi Bros. also provides additional warranty coverage on specific products as specified herein.

**Magnum Force pumps-** 12 years limited: the case, RingLoks, impeller, diffuser, seal plate, and pump lid have 5 years full and 7 years pro-rated thereafter; the o-rings, basket, seal and other hardware have one full year from the date of installation. The motor carries a 3 year original manufacturer's warranty.

**Cygnets pumps-** 10 years limited; the case, RingLoks, impeller, diffuser, seal plate, and pump lid have 5 years full and 5 years pro-rated thereafter; the o-rings, basket, seal and other hardware have one full year from the date of installation. The motor carries a 3 year original manufacturer's warranty.

**LR pumps-** 4 years limited: the case, RingLoks, impeller, diffuser, seal plate, and pump lid have 2 years full and 2 years pro-rated thereafter; the o-rings, basket, seal and other hardware have one full year from the date of installation. The motor carries a 1 year original manufacturer's warranty.

**SherLok filters-** 12 years limited: the tank body and RingLok have 5 full years and 7 years pro-rated thereafter; all internal components have one full year from date of installation.

**TricLOPS filters-** 12 years limited: the tank body and RingLok have 5 full years and 7 years pro-rated thereafter; all internal components have one full year from date of installation.

**Avalanche filters-** 12 years limited: the tank body and RingLok have 5 full years and 7 years pro-rated thereafter; all internal components have one full year from date of installation.

**EarthWorks filters-** 12 years limited: the tank body and RingLok have 5 full years and 7 years pro-rated thereafter; the valve and all other components have one full year from date of installation.

**Laser filters-** 12 years limited: the tank body and RingLok have 5 full years and 7 years pro-rated thereafter; the valve and other internal components have one full year from date of installation.

**SandStorm filters-** 12 years limited: the tank body and RingLok have 5 full years and 7 years pro-rated thereafter; the valve and other internal components have one full year from date of installation.

JBD's warranty obligation with regard to equipment not of its own manufacture is limited to the warranty actually extended to JBD by its suppliers. Performance of equipment is further warranted to be in accordance with stated ratings when properly installed under normal conditions of operation.

This warranty extends only to the original retail purchaser and only during the time in which the original retail purchaser occupies the site where the product was originally installed. **The product warranty card must be on file with Jacuzzi Bros. to qualify for the additional warranty coverage listed above. Otherwise, Jacuzzi Bros. is limited to paragraph one above.**

Warranty claims shall be made by contacting the installing JBD dealer (point of purchase) as soon as possible after the discovery of any alleged defect. If the claim is determined to be valid, JBD will take corrective action as promptly as reasonably possible.

JBD at its discretion may replace or repair any product that fails under this warranty after inspection by an authorized company representative or after JBD has received the product at our factory. Replacement or repair cannot be made until after the product is inspected. All charges or expenses for freight to and from the factory, removal and reinstallation of the product, or installation of a replacement product are the responsibility of the purchaser.

**THIS WARRANTY IS EFFECTIVE JANUARY 1, 1998. ANY IMPLIED WARRANTIES WHICH THE PURCHASER MAY HAVE, INCLUDING MERCHANTABILITY AND FITNESS FOR A PARTICULAR PURPOSE, SHALL NOT EXTEND BEYOND THE APPLICABLE WARRANTY PERIOD. Some states do not allow limitations on how long an implied warranty lasts, so the above limitation may not apply to you. IN NO EVENT SHALL JBD BE LIABLE FOR INCIDENTAL OR CONSEQUENTIAL DAMAGES. Some states do not allow the exclusion or limitation of incidental or consequential damages, so the above may not apply to you.**

This warranty applies to products used in swimming pool, spa, & aquaculture applications only and does not apply to any product which has been subjected to negligence, alteration, accident, abuse, misuse, improper installation, vandalism, civil disturbances, or acts of God (including but not limited to freeze damage, lightning strikes, and other damage caused by catastrophic events). The only warranties authorized by JBD are those set forth herein. JBD does not authorize other persons to extend any warranties with respect to its products, nor will JBD assume liability for any unauthorized warranties made in



# Radio/Receiver Board (Component Locations)

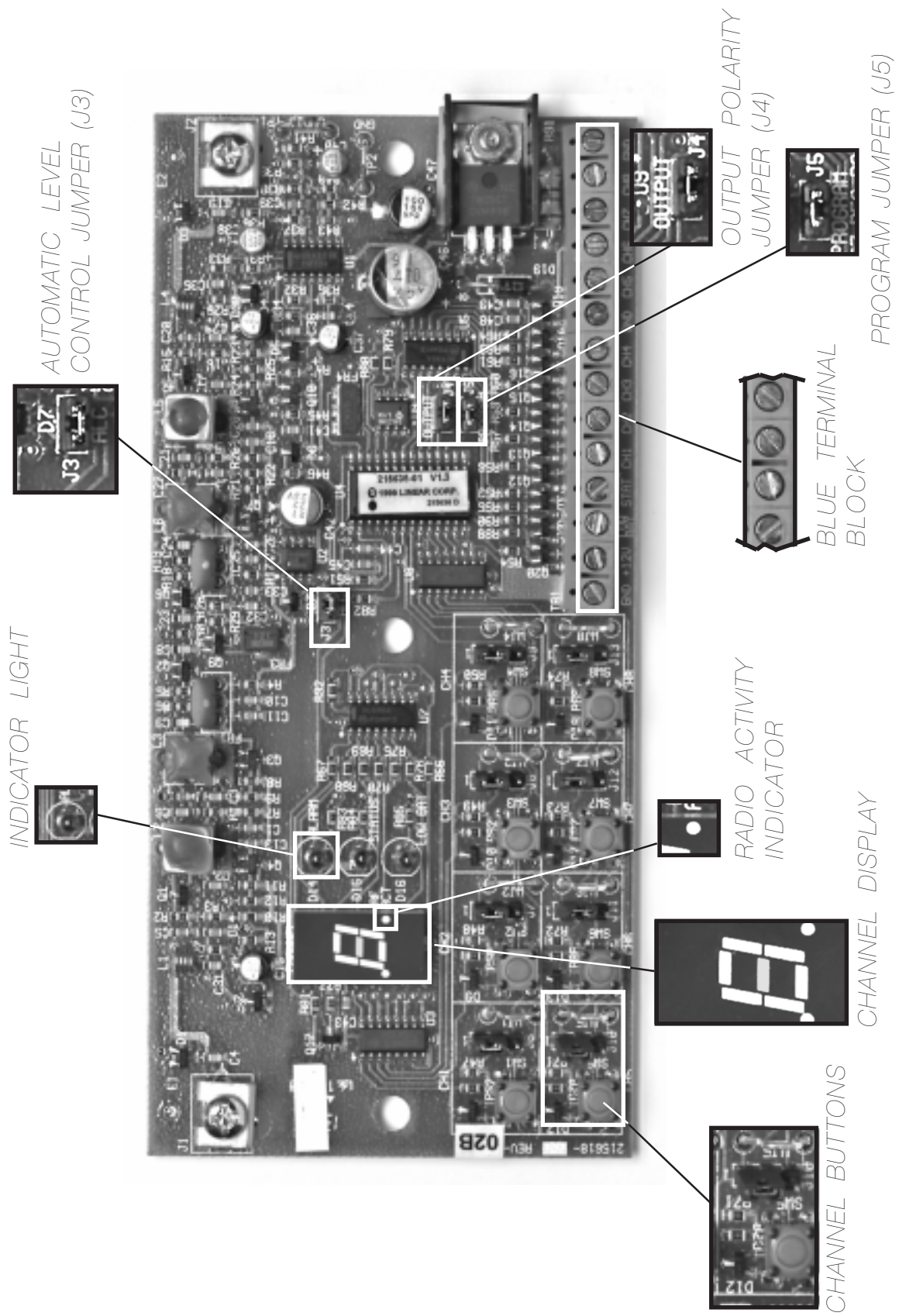

# Channel Buttons Detail

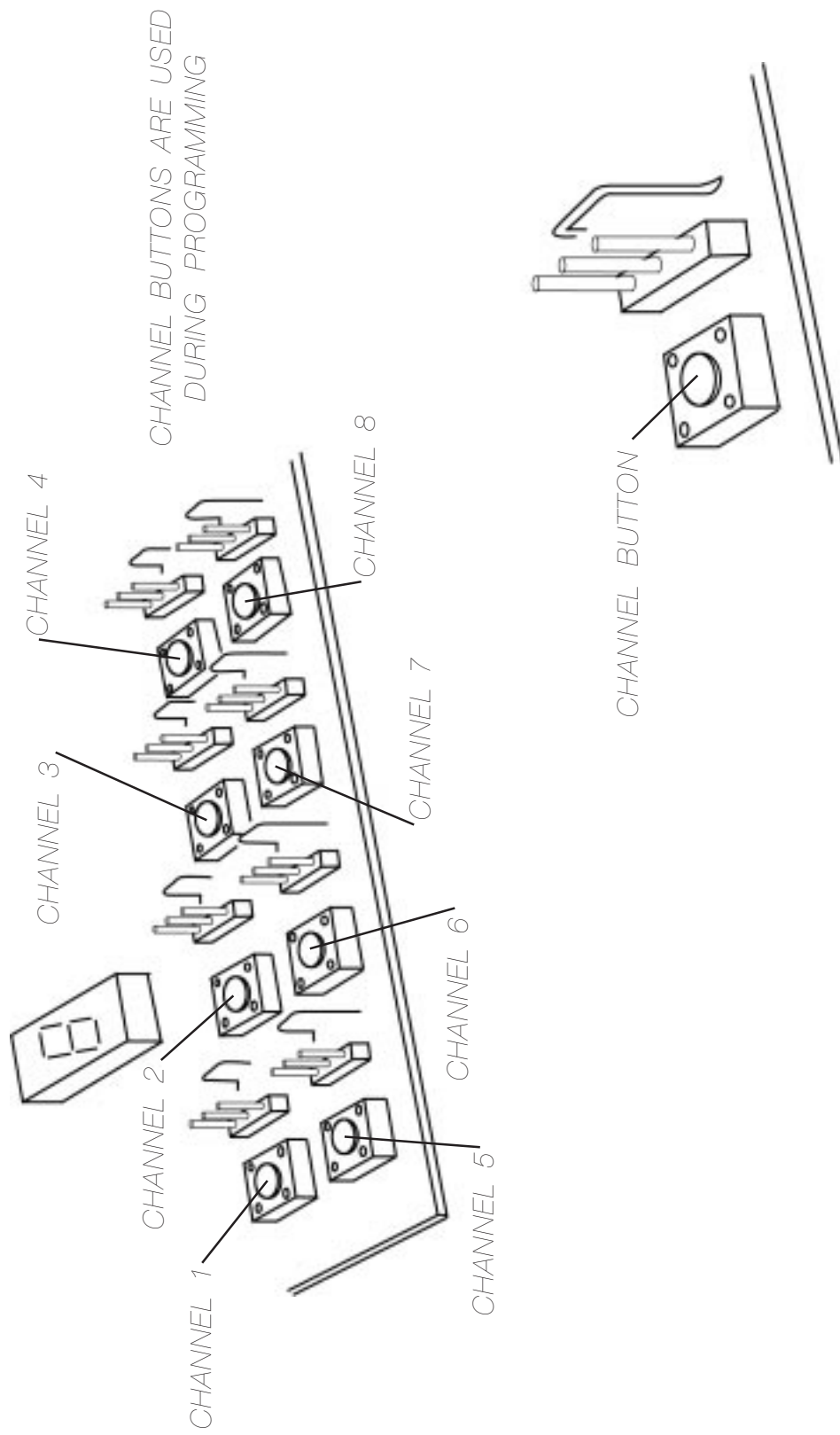

MM-8 SHOWN

# PROGRAMMING

1.

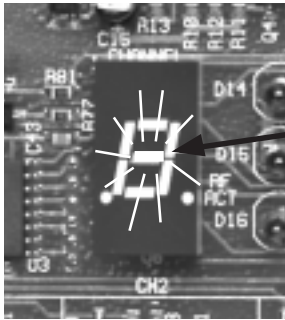

Be certain that power to the MasterMind is “On”. The **center bar** of the “**Channel Display**” on the Radio/Receiver Board will **flash red**, indicating that power has been applied.

2.

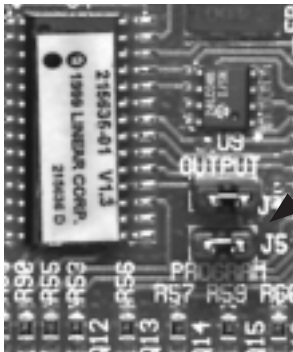

Locate the “**Program Jumper Pin**” (labeled **J5**) located above the blue terminal block. Remove the “Program Jumper Pin”. The “**Channel Display**” will show the letter “**P**” indicating that the unit is ready to be programmed.

3.

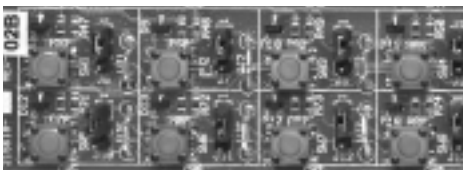

Locate the “**Red Channel Buttons**” just below the “Channel Display”. Each Channel is marked **CH1**, **CH2**, etc.. To program Channel #1 (**CH1**), briefly press and **release** “Channel Button” **CH1**. The “**Channel Display**” will show the number “**1**”.



(**Note:** After pressing the “Channel Button”, you have four seconds to initiate Step 4. If more than 4 seconds elapse, the “Channel Display” will switch back to the letter “P” and you will need to repeat Step 3.)

# PROGRAMMING

4.



Indicator Light

Channel Display

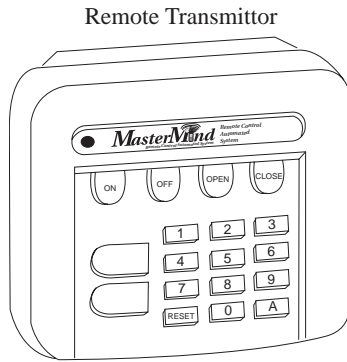

On your **Remote Transmitter**, first press the button marked **“1”**, then press the button marked **“On”**. After several seconds, the **“Indicator Light”** next to the **“Channel Display”** will **blink 3 times** and the **“Channel Display”** will switch back to the letter **“P”**.

Repeating **Step 3**, briefly press and **release** **“Channel Button” CH1** a second time. The **“Channel Display”** will once again show the number **“1”**. On your **Remote Transmitter**, again press the button marked **“1”**, but this time follow up by pressing the button marked **“Off”**. After several seconds, the **“Indicator Light”** next to the **“Channel Display”** will **blink 3 times** and the **“Channel Display”** will switch back to the letter **“P”**.

The programming for Channel #1 (CH1) is now complete. Follow the same procedures for the remaining Channels you wish to program. (**Remember**, you must begin programming the Remote Transmitter within 4 seconds of pressing a **“Red Channel Button”** on the Radio/Receiver Board.)

5.

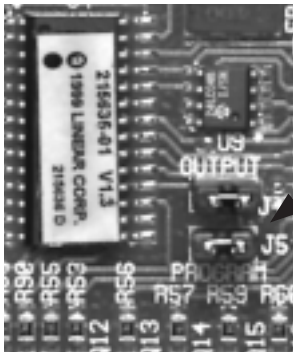

Once you have completed programming the remaining Channels, reinstall the **“Program Jumper Pin”** at position **J5** on the Radio/Receiver Board.

6.

You are now ready to **“TEST”** the programming. Leave power to the MasterMind **“On”**, but turn the circuit breakers that control each component (pump, lights, valves, etc.) **“Off”**.

Press button marked **“1”** on the Remote Transmitter and then press the button marked **“On”**. The **“Channel Display”** will show the number **“1”**, indicating that Channel #1 is active. The **Indicator Light** next to the **“Channel Display”** will also come **“On”** and remain **“On”** as long as any Channel is activated.

Channel Display

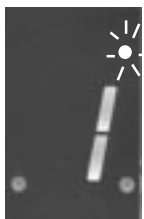

Each time you press a **“numbered”** button on the Remote Transmitter and follow it by pressing the **“On”** button, the corresponding Channel will activate, and the **“indicator Light”** will be **“On”** in the **“Channel Display”**. You will also hear a **“click”** indicating that the relay on the main relay board has engaged. Test each Channel you have programmed. (Note: The **“Channel display”** will continuously scroll through each active channel, in ascending order, indicating what equipment is currently **“On”**.)

# PROGRAMMING

7.

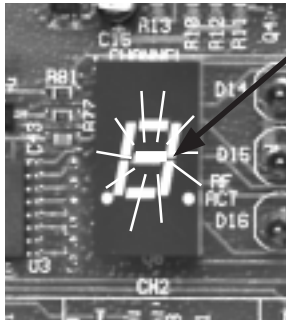

After you have determined that each Channel is properly programmed, turn each Channel “Off” by pressing the appropriate “number” button followed by the “off” button. (**Note: When all components connected to the MasterMind are in the “Off” position, the center bar of the “Channel Display” will flash red.**) If all of the equipment controlled by the MasterMind is installed and ready for use, switch the circuit breakers controlling that equipment “On”. Your MasterMind is ready for use.

*Note: If you are also programming an Interior Display to operate in conjunction with your MasterMind unit, You must first turn the power to the MasterMind “Off”. Otherwise the radio/reciver boards in the MasterMind and the Interior Display will NOT synchronize.*

# TO CLEAR PROGRAMMING

1.

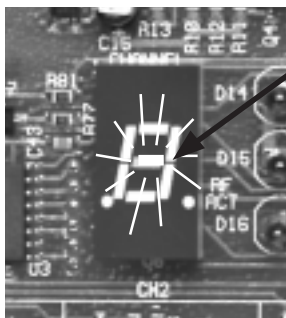

Be certain that all Channels are in the “Off” position. The **center bar** of the “Channel Display” will **flash red**.



# TO CLEAR PROGRAMMING

2.

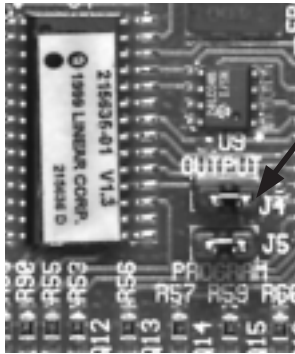

Locate the “**Program Jumper Pin**” (labeled **J5**) located above the blue terminal block. Remove the “**Program Jumper Pin**”. The “**Channel Display**” will show the letter “**P**” indicating that the Channel programming is ready to be cleared.



3.

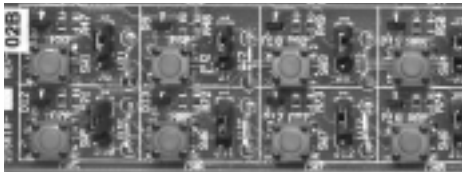

Locate the “**Red Channel Buttons**” just below the “**Channel Display**”. Each Channel is marked **CH1**, **CH2**, etc.. Select the “**Channel Button**” for the Channel you wish to clear. Press and hold the selected “**Channel Button**”. The “**Channel Display**” will show the number of the Channel you have selected to clear.

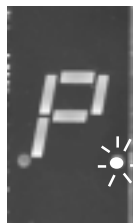

Continue holding the selected “**Red Channel Button**”. After several seconds, the **Indicator Light** next to the “**Channel Display**” will **blink once** for every Remote Transmitter that is programmed to that Channel (up to 32 transmitters can be programmed to each MasterMind). After several more seconds, the **Indicator Light** will **blink 3 times quickly** and the “**Channel Display**” will change to the letter “**P**”, indicating that the Channel is clear. Follow the same procedure for the remaining Channels you wish to clear.

4.

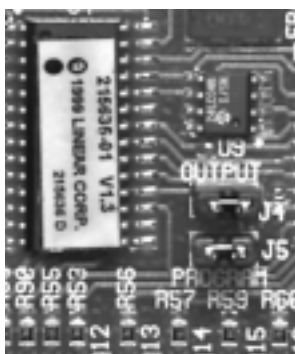

You are now ready to reprogram the cleared Channels. Follow the steps in the “**Programming**” section above. When finished, replace the “**Program Jumper Pin**” at position **J5** on the Radio/Receiver board.

# HELPFUL HINTS

1.

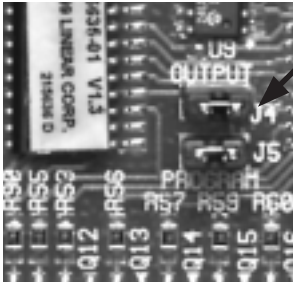

The “**Output Polarity Jumper Pin**” (labeled **J4**) located directly above the “**Program Jumper Pin**” (J5) is a **manual override** that bypasses the Radio/Receiver Board and allows you to run all of the components connected to the MasterMind without using the Remote Transmitter. Simply remove the “**Output Polarity Jumper Pin**” (J4), and every component connected to the MasterMind will turn “**On**” at the same time.

If one of the components connected to the MasterMind does **not** turn “**On**”, it indicates that you may have a problem with either the MasterMind relay board or the electrical connections. When you wish to turn everything “**Off**” again, simply replace the “**Output Polarity Jumper Pin**” (J4).

2.



There is a tiny “**decimal point**” **LED** light in the bottom right-hand corner of the “**Channel Display**”. This light should flash any time you press a button on your Remote Transmitter, indicating that the Remote Transmitter is sending a signal. If this “**decimal point**” does **not** flash when using your Remote Transmitter, it indicates a potential problem with the Remote Transmitter. Check the battery.

3.



When any Channels are in operation or “**On**”, those Channel number(s) will continuously scroll, in ascending order, across the “**Channel Display**”.

# MasterMind

Remote Control Automated System

## Portable Transmitter



"The Most Trusted Name In Water."™

# MM-REMOTE

Red indicator lights  
when transmitting

“On”

“Off”

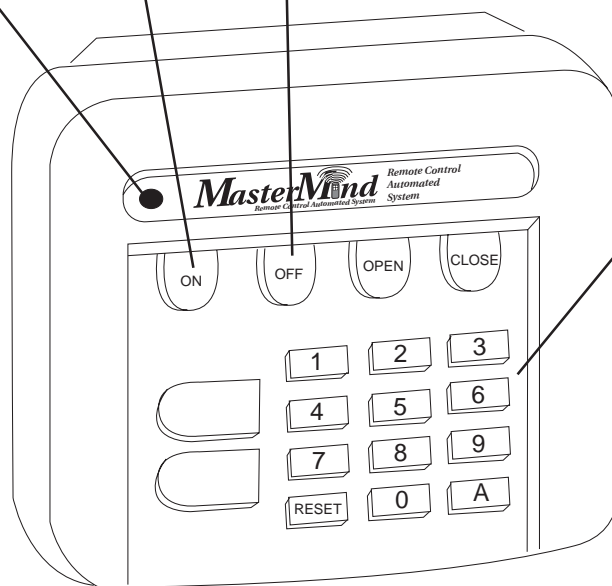

Numbered  
buttons

The MM-REMOTE is a multi-button, “direct button”, “direct logic” transmitter with 8 codes (buttons 1 through 8). Press the “numbered” button that corresponds to the Channel you wish to control, and then “tell” that Channel what you wish to do by pressing either “On” or “Off”. When transmitting, red indicator will light for 5-7 seconds.

# BATTERY INSTALLATION



**1** From top of case twist screwdriver between base halves until it pops open

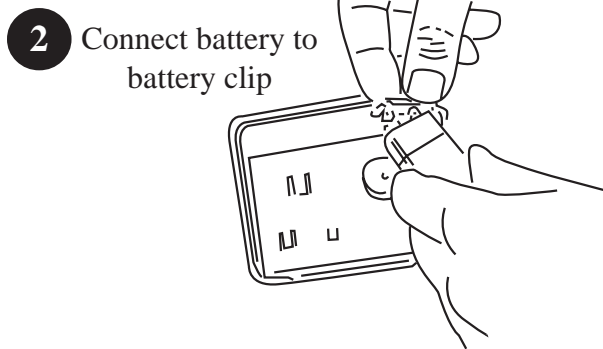

**2** Connect battery to battery clip

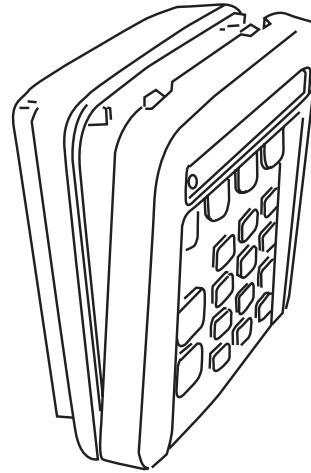

**3** Then hook bottom edge together, and snap case shut

# MOUNTING INSTRUCTIONS

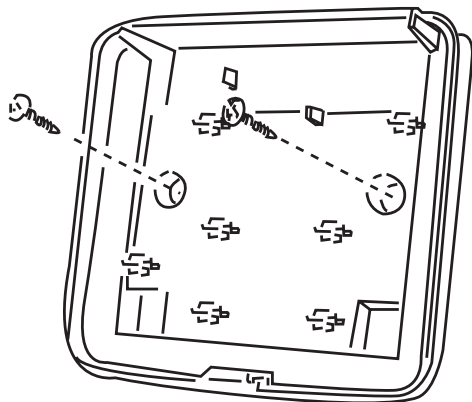

Attach rear case to wall with the two screws provided. Mount at convenient location near primary entry/exit door.

Use the four scratch deterrent pads provided for table top use.

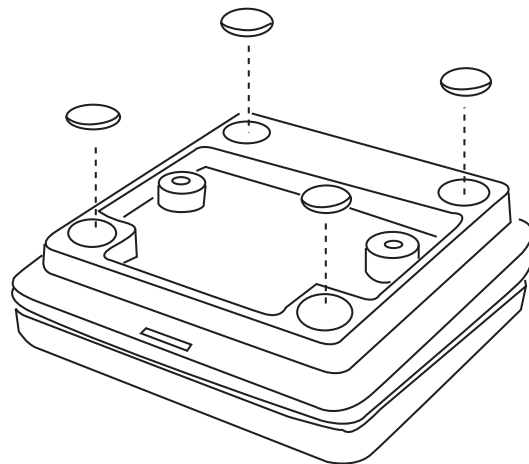

## **LIMITED WARRANTY**

This product is warranted against defects in material and workmanship for twelve (12) months from the electrician's recorded date of installation. This warranty extends only to wholesale customers who buy direct from Jacuzzi Bros. or through Jacuzzi Bros.' normal distribution channels. Jacuzzi Bros. does not warrant this product to consumers. Consumers should inquire from their selling dealer as to the nature of the dealer's warranty, if any. There are no obligations or liabilities on the part of Jacuzzi Bros. for consequential damages arising out of or in connection with use or performance of this product or other indirect damages with respect to loss of property, revenue, or profit, or cost of removal, installation, or reinstallation. All requests for the replacement of damages or non-functioning goods must be made within 10 days of proof of purchase and of electrician installation and are subject to approval by Jacuzzi Bros. This Jacuzzi Bros. warranty is in lieu of all other warranties express or implied.

## **IMPORTANT**

Radio controls provide a reliable communications link and fill an important need in portable wireless signaling. However, there are some limitations which must be observed.

- For U.S. installations only: the radios are required to comply with FCC rules and regulations as part 15 devices. As such, they have limited transmitter power and therefore limited range.
- A receiver cannot respond to more than one transmitted signal at a time and may be blocked by radio signals that occur on or near their operation frequencies, regardless of their code settings.
- Changes or modifications to the device may void FCC compliance.
- Infrequently used radio links should be tested regularly to protect against undetected interference or fault.
- A general knowledge of radio and its vagaries should be gained prior to acting as a wholesale distributor or dealer, and these facts should be communicated to the ultimate users.