



Product Name:

Part Numbers: 640-209-58123 (Sandstone), 640-209-58124 (Gray Granite)

General Notes:

The heliX™ is a 7'4" tall height slide with integral polyethylene runway and ladder. The heliX™ is available in a right curve configuration.

Application:

This slide is intended for use on in-ground residential pools. With proper deck anchoring, this product is suitable for use in most geographic regions.

Specifications:

- 1 Runway: The slide runway is made from thick, durable, roto-molded polyethylene.
- 2 Water Delivery System – Comes standard with the slide utilizing 1" PVC flex hose for a flow rate of up to 20 GPM.
- 3 Fountain Feature – In addition to the main water nozzle, the Helix slide also comes standard with a center post fountain feature. The fountain feature can be run together with the main water nozzle or alone.
- 4 Handrail: The two (2) ladder handrails are molded into the ladder and are made of molded polyethylene.
- 5 Ladder: The ladder is inclined 20° off vertical with eight (8) enclosed steps for ease of climbing.
- 6 Anchor Assembly (Included): Slide is anchored to the deck using eight (8) ½" (12.70mm) diameter stainless steel anchor studs with hardware. (Not shown)

Product Numbers and Shipping Weight:

MODEL NUMBER	DESCRIPTION	SHIPPING WEIGHT
640-209-58123	heliX™ Sandstone	300 lbs. (136 kg)
670-209-58124	heliX™ Gray Granite	300 lbs. (136 kg)

Specification Number:	SRS-216	
Product Description:	heliX™ Slide	
S.R. Smith Part Number:	640-209-58123, 640-209-58124	
Revision:	A	Date: 1/09/13
Written By:	Bill Svendsen	Date: 1/09/13
Approved By:		Date: 1/09/13
Page 3 of 3	Proprietary and confidential: The information contained in this specification is the sole property of S.R. Smith LLC. Any reproduction in part or whole without the written consent of S.R. Smith LLC is prohibited.	

S.R. Smith, LLC
P.O. Box 400, 1017 SW Berg Parkway
Canby, Oregon 97013
Tel: (888) 677-7776 (503) 266-2231
Fax: (503) 266-4334
www.srsmith.com

HELIX™ SLIDE

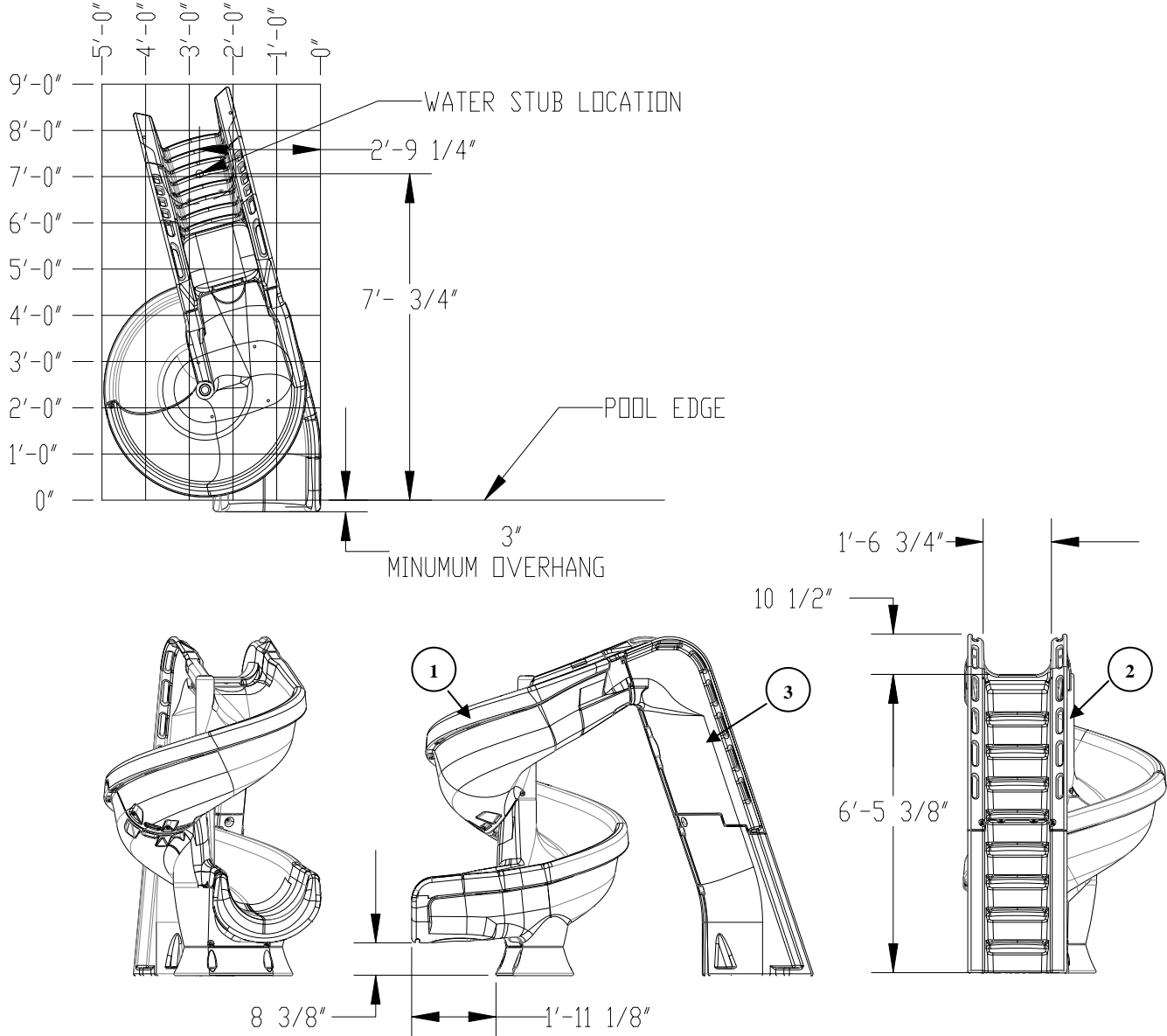

Specification Number:	SRS-216	
Product Description:	Helix™ Slide	
S.R. Smith Part Number:	640-209-58123, 640-209-58124	Scale: NTS
Revision:	A	Date: 1/09/13
Written By:	BILL SVENDSEN	Date: 1/09/13
Approved By:		Date: 1/09/13
Page 1 of 3	Proprietary and confidential: The information contained in this specification is the sole property of S.R. Smith LLC. Any reproduction in part or whole without the written consent of S.R. Smith LLC is prohibited.	

S.R. Smith, LLC
P.O. Box 400, 1017 SW Berg Parkway
Canby, Oregon 97013
Tel: (888) 677-7776 (503) 266-2231
Fax: (503) 266-4334
www.srsmith.com



S.R. Smith LLC

Product Specifications

Helix™ Slide Placement

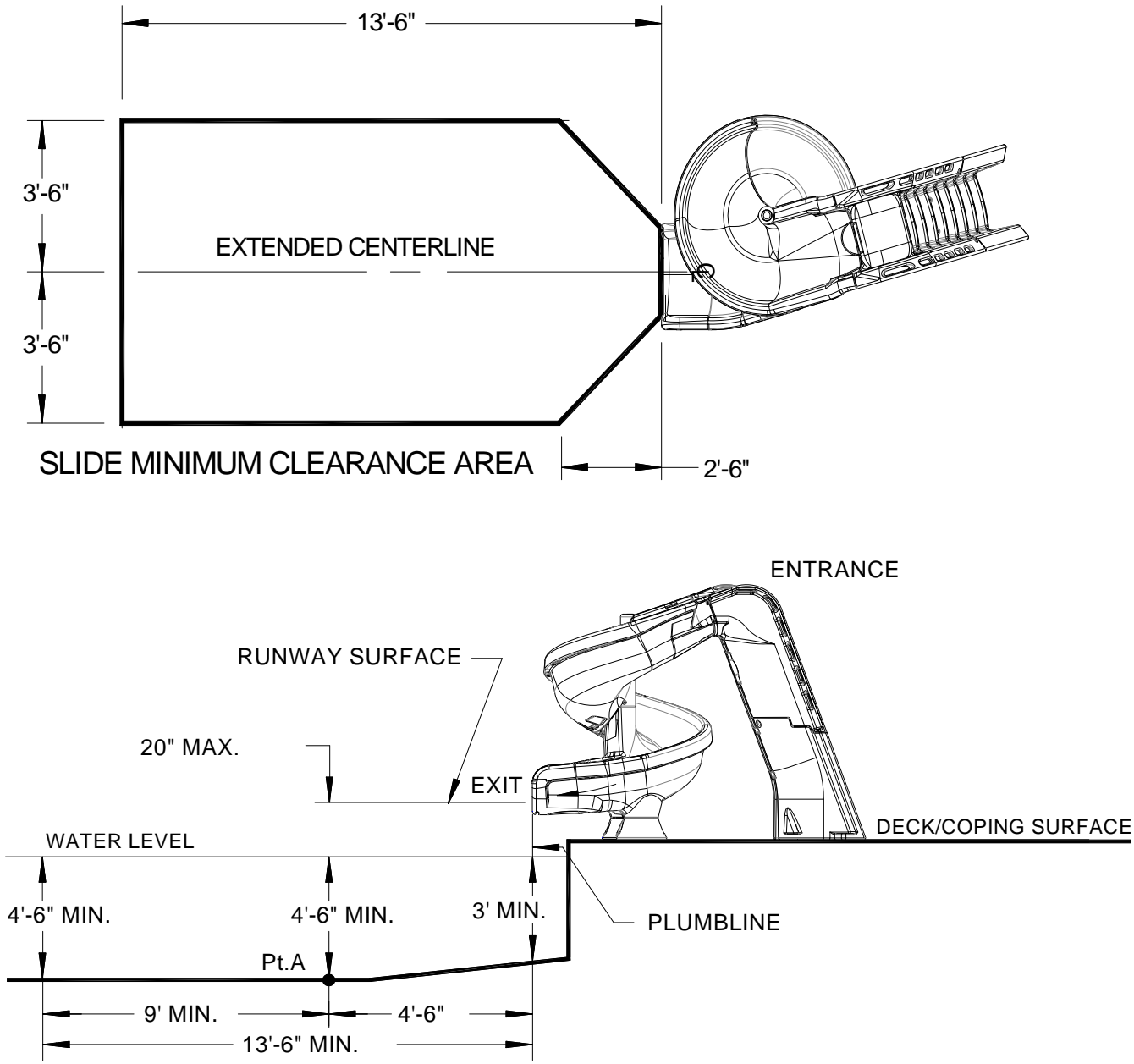

Specification Number:	SRS-216	
Product Description:	Helix™ Slide	
S.R. Smith Part Number:	640-209-58123, 640-209-58124	Scale: NTS
Revision:	A	Date: 1/09/13
Written By:	Bill Svendsen	Date: 1/09/13
Approved By:		Date: 1/09/13
Page 2 of 3	Proprietary and confidential: The information contained in this specification is the sole property of S.R. Smith LLC. Any reproduction in part or whole without the written consent of S.R. Smith LLC is prohibited.	

S.R. Smith, LLC
 P.O. Box 400, 1017 SW Berg Parkway
 Canby, Oregon 97013
 Tel: (888) 677-7776 (503) 266-2231
 Fax: (503) 266-4334
 www.srsmith.com