

AQUA LOGIC

Automation and Chlorination



(actuators, cell & remote display not included - order separately)

Installation Manual

for model
AQL-P-4

GOLDLINE
CONTROLS INC.
A HAYWARD COMPANY

www.goldlinecontrols.com
888-921-7665

IMPORTANT SAFETY INSTRUCTIONS

When using this electrical equipment, basic safety precautions should always be followed, including the following:



- **READ AND FOLLOW ALL INSTRUCTIONS**
-  **WARNING: Disconnect all AC power during installation.**
-  **WARNING: Water in excess of 100 degrees Fahrenheit may be hazardous to your health.**
-  **WARNING: To reduce the risk of injury, do not permit children to use this product unless they are closely supervised at all times.**
- A green colored terminal marked “Earth Ground” is located inside the wiring compartment. To reduce the risk of electric shock, this terminal must be connected to the grounding means provided in the electric supply service panel with a continuous copper wire equivalent in size to the circuit conductors supplying the equipment.
- One bonding lug for US models (two for Canadian models) is provided on the external surface. To reduce the risk of electric shock, connect the local common bonding grid in the area of the swimming pool, spa, or hot tub to these terminals with an insulated or bare copper conductor not smaller than 8 AWG US / 6 AWG Canada.
- All field installed metal components such as rails, ladders, drains, or other similar hardware within 3 meters of the pool, spa or hot tub shall be bonded to the equipment grounding bus with copper conductors not smaller than 8 AWG US / 6 AWG Canada.
- **SAVE THESE INSTRUCTIONS**

Table of Contents

Introduction	Before You Begin.....	1
	Installation Steps.....	2
1. Preparing Pool/Spa Water	General Water Chemistry.....	3
	Salt.....	4
2. Mounting Equipment	Aqua Logic Control Center.....	6
	Temperature Sensors.....	6
	Optional AQL-CL Chlorination Kit.....	6
	Optional Wired Remote Display/Keypad.....	6
	Optional Base Receiver.....	7
	Optional Valve Actuators.....	7
3. Plumbing	Pool/Spa Configuration.....	8
	Turbo Cell.....	9
	Flow Switch.....	9
4. Electrical Wiring	Main Service.....	10
	Grounding and Bonding.....	10
	Circuit Breaker Installation and Wiring.....	10
	General Purpose Outlet.....	11
	Aqua Logic Control Power.....	11
	High Voltage Pool Equipment.....	12
	Low Voltage Wiring.....	13
5. Configuration	Configuration Menu.....	19
6. System Startup and Checkout	Before Startup.....	26
	Heater Checkout.....	26
	Service Mode.....	27
7. Warranty	Aqua Logic Limited Warranty.....	32

Introduction

Before You Begin

What's Included

Before attempting to install the Aqua Logic system, check that the following components have been included in the package:

Aqua Logic Electronics Unit

(3) Temperature sensors with 15 ft. (5m) cable, hose clamp

What's NOT Included

Some of the additional items that you may need to complete an installation include:

Circuit breakers

None are included with control—see page 11 and inside of door for suitable breakers

Wire

4-conductor cable (electronics unit to remote display/keypad)

Wire/conduit for 100A service from main panel to Aqua Logic

Wire/conduit for filter pump and other high voltage loads

Wire for bonding

Miscellaneous

Utility electrical outlet and weatherproof cover (for mounting on side of Aqua Logic)

Mounting hardware (screws, etc.) for mounting Aqua Logic and remote display/keypad

Valves (use standard Jandy, Pentair/Compool, or Hayward valves)

Additional valve actuators

Accessory Products - Order Separately

AQL-CL	Chlorination kit
AQL-CL-25FT	Chlorination kit with 25ft cable
AQL-WMW-P4	Wired Remote Display
AQL-SS-RF	Wireless Spaside Remote Control (AQL-BASE-RF required)
AQL-BASE-RF	Base Receiver
GVA-24	Valve Actuator
V&A-xx	Valve & Actuator (xx=1P (1.5" pos. seal), -2P (2" pos. seal))

Installation Steps

Details on each installation step are presented on the following pages:

1. Prepare the pool water (page 3)
 - General Water Chemistry
 - Salt
2. Mounting the equipment (page 6)
 - Aqua Logic main unit
 - Remote display/keypad (optional)
 - Temperature sensors
 - Valve actuators (if applicable)
3. Plumbing (page 8)
 - General Pool Equipment
 - Turbo Cell
 - Flow Switch
4. Electrical Wiring (page 10)
 - Main service
 - Grounding and bonding
 - Circuit breakers
 - Aqua Logic control power
 - High Voltage pool equipment
 - Low voltage wiring (temperature sensors, flow switch, etc.)
5. Aqua Logic control configuration (page 19)
6. System Startup and checkout (page 26)

1. Preparing Pool/Spa Water

General Water Chemistry

Salt is required only if you are using the chlorinator features on the Aqua Logic Control. If you are NOT using the chlorinator, it is recommended that you follow all of the other chemistry recommendations besides salt. Refer to the description of the Aqua Logic configuration menu for information on enabling/disabling the chlorinator (see page 19).

Water Chemistry

The table below summarizes the levels that are recommended by the National Spa and Pool Institute (NSPI). The only special requirements for the Aqua Logic are the salt level and stabilizer.

CHEMICAL	IDEAL LEVELS
Salt	2700 to 3400 ppm
Free Chlorine	1.0 to 3.0 ppm
pH	7.2 to 7.6
Cyanuric Acid (Stabilizer)	60 to 80 ppm (80 ppm best)
Total Alkalinity	80 to 120 ppm
Calcium Hardness	200 to 400 ppm
Metals	0 ppm
Saturation Index	-0.2 to +0.2 (0.0 best)

Saturation index

The saturation index (Si) relates to the calcium and alkalinity in the water and is an indicator of the pool water “balance”. Your water is properly balanced if the Si is 0 ± 0.2 . If the Si is below -0.2, the water is corrosive and plaster pool walls will be dissolved into the water. If the Si is above +0.2, scaling and staining will occur. Use the chart below to determine the saturation index.

$$Si = pH + Ti + Ci + Ai - 12.1$$

°C	°F	Ti	Calcium Hardness	Ci	Total Alkalinity	Ai
12	53	.3	75	1.5	75	1.9
16	60	.4	100	1.6	100	2.0
			125	1.7	125	2.1
19	66	.5	150	1.8	150	2.2
			200	1.9	200	2.3
24	76	.6	250	2.0	250	2.4
			300	2.1	300	2.5
29	84	.7	400	2.2	400	2.6
			600	2.4	600	2.8
34	94	.8	800	2.5	800	2.9
39	103	.9				

How to use: Measure pool pH, temperature, calcium hardness, and total alkalinity. Use the chart above to determine Ti, Ci, and Ai from your measurements. Insert values of pH, Ti, Ci and Ai into the above equation. If Si equals .2 or more, scaling and staining may occur. If Si equals -.2 or less corrosion or irritation may occur.

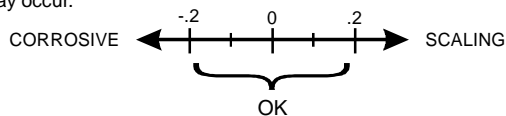

The pool's chemistry must be balanced BEFORE activating the Aqua Logic's optional chlorinator function. NOTE: If the pool does not have new water, add metal remover and non-copper based algaecide to the pool, per manufacturer's instructions. This ensures a quick, troublefree transfer to the Aqua Logic system.

Salt

Adjust salt levels only when using the AQL-P-4 optional chlorinator function (requires the use of the AQL-CL chlorination kit sold separately).

Salt Level

Use the chart below to determine how much salt in pounds or (Kgs) should be added to reach the recommended levels. Use the equations on the following page (measurements are in feet/gallons and meters/liters) if pool size is unknown.

The operating salt level is between 2700-3400 PPM (parts per million) with 3200 PPM being optimal. Before adding any salt, test the salt level. This is especially important for retrofit installation to older pools where all of the chlorine added to the pool over time is ending up as salt. If the level is low, determine the number of gallons in the pool and add salt according to the chart below. A low salt level will reduce the efficiency of the sanitization and result in low chlorine production. A high salt level can cause the Aqua Logic to stop chlorinating. The salt in your pool/spa is constantly recycled and the loss of salt throughout the swimming season should be minimal. This loss is due primarily to the addition of water because of splashing, backwashing, or draining (because of rain). Salt is not lost due to evaporation.

POUNDS and (Kg) OF SALT NEEDED FOR 3200 PPM

Current salt level ppm	Gallons and (Liters) of Pool/Spa water																
	8,000 (30,000)	10,000 (37,500)	12,000 (45,000)	14,000 (52,500)	16,000 (60,000)	18,000 (67,500)	20,000 (75,000)	22,000 (82,500)	24,000 (90,000)	26,000 (97,500)	28,000 (105,000)	30,000 (112,500)	32,000 (120,000)	34,000 (127,500)	36,000 (135,000)	38,000 (142,500)	40,000 (150,000)
0	213 (97)	267 (121)	320 (145)	373 (170)	427 (194)	480 (218)	533 (242)	587 (267)	640 (291)	693 (315)	747 (339)	800 (364)	854 (388)	907 (412)	960 (436)	1013 (460)	1067 (484)
200	200 (91)	250 (114)	300 (136)	350 (159)	400 (182)	450 (205)	500 (227)	550 (250)	600 (273)	650 (295)	700 (318)	750 (341)	800 (363)	850 (385)	900 (408)	950 (430)	1000 (453)
400	187 (85)	233 (106)	280 (127)	327 (148)	373 (170)	420 (191)	467 (212)	513 (233)	560 (255)	607 (276)	653 (297)	700 (318)	747 (339)	793 (360)	840 (382)	887 (403)	933 (424)
600	173 (79)	217 (98)	260 (118)	303 (138)	347 (158)	390 (177)	433 (197)	477 (217)	520 (236)	563 (256)	607 (276)	650 (297)	693 (317)	737 (337)	780 (358)	823 (378)	867 (398)
800	160 (73)	200 (91)	240 (109)	280 (127)	320 (145)	360 (164)	400 (182)	440 (200)	480 (218)	520 (236)	560 (255)	600 (273)	640 (291)	680 (310)	720 (328)	760 (346)	800 (364)
1000	147 (67)	183 (83)	220 (100)	257 (117)	293 (133)	330 (150)	367 (167)	403 (183)	440 (200)	477 (217)	513 (233)	550 (250)	587 (267)	623 (283)	660 (300)	697 (317)	733 (333)
1200	133 (61)	167 (76)	200 (91)	233 (106)	267 (121)	300 (136)	333 (152)	367 (167)	400 (182)	433 (197)	467 (212)	500 (227)	533 (243)	567 (258)	600 (274)	633 (289)	667 (304)
1400	120 (55)	150 (68)	180 (82)	210 (95)	240 (109)	270 (123)	300 (136)	330 (150)	360 (164)	390 (177)	420 (191)	450 (205)	480 (218)	510 (232)	540 (246)	570 (259)	600 (263)
1600	107 (48)	133 (61)	160 (73)	187 (85)	213 (97)	240 (109)	267 (121)	293 (133)	320 (145)	347 (158)	373 (170)	400 (182)	427 (195)	453 (207)	480 (219)	507 (231)	533 (243)
1800	93 (42)	117 (53)	140 (64)	163 (74)	187 (85)	210 (95)	233 (106)	257 (117)	280 (127)	303 (138)	327 (148)	350 (159)	373 (169)	397 (180)	420 (190)	443 (201)	467 (211)
2000	80 (36)	100 (45)	120 (55)	140 (64)	160 (73)	180 (82)	200 (91)	220 (100)	240 (109)	260 (118)	280 (127)	300 (136)	320 (145)	340 (154)	360 (163)	380 (172)	400 (181)
2200	67 (30)	83 (38)	100 (45)	117 (53)	133 (61)	150 (68)	167 (76)	183 (83)	200 (91)	217 (98)	233 (106)	250 (114)	267 (121)	283 (129)	300 (137)	317 (144)	333 (152)
2400	53 (24)	67 (30)	80 (36)	93 (42)	107 (48)	120 (55)	133 (61)	147 (67)	160 (73)	173 (79)	187 (85)	200 (91)	213 (98)	227 (104)	240 (110)	253 (117)	267 (123)
2600	40 (18)	50 (23)	60 (27)	70 (32)	80 (36)	90 (41)	100 (45)	110 (50)	120 (55)	130 (59)	140 (64)	150 (68)	160 (73)	170 (77)	180 (81)	190 (86)	200 (90)
2800	27 (12)	33 (15)	40 (18)	47 (21)	53 (24)	60 (27)	67 (30)	73 (33)	80 (36)	87 (39)	93 (42)	100 (45)	107 (48)	113 (51)	120 (54)	127 (57)	133 (60)
3000	13 (6)	17 (8)	20 (9)	23 (11)	27 (12)	30 (14)	33 (15)	37 (17)	40 (18)	43 (20)	47 (21)	50 (23)	53 (24)	57 (26)	60 (27)	63 (29)	67 (30)
3200	Ideal	Ideal	Ideal	Ideal	Ideal	Ideal	Ideal	Ideal	Ideal	Ideal	Ideal	Ideal	Ideal	Ideal	Ideal	Ideal	Ideal
3400	OK	OK	OK	OK	OK	OK	OK	OK	OK	OK	OK	OK	OK	OK	OK	OK	OK
3600+	Dilute	Dilute	Dilute	Dilute	Dilute	Dilute	Dilute	Dilute	Dilute	Dilute	Dilute	Dilute	Dilute	Dilute	Dilute	Dilute	Dilute

Pool Sizing Formula

	Gallons (pool size in feet)	Liters (pool size in meters)
Rectangular	Length x Width x Average Depth x 7.5	Length x Width x Average Depth x 1000
Round	Diameter x Diameter x Average Depth x 5.9	Diameter x Diameter x Average Depth x 785
Oval	Length x Width x Average Depth x 6.7	Length x Width x Average Depth x 893

Type of Salt to Use

It is important to use only sodium chloride (NaCl) salt that is greater than 99% pure. This is common food quality or water softener salt and is usually available at building supply stores in 40-80 lb. bags labeled coarse or fine “Solar Salt”. It is also acceptable to use water conditioning salt pellets, however, it will take longer for them to dissolve. Do not use rock salt, or salt with more than 1% of yellow prussiate of soda, salt with anti-caking additives, or iodized salt.

How to Add Salt

For new plaster pools, wait 10-14 days before adding salt to allow the plaster to cure. Turn the circulating pump on and add salt directly into the pool. Brush the salt around to speed up the dissolving process—do not allow salt to pile up on the bottom of the pool. Run the filter pump for 24 hours with the suction coming from the main drain (use pool vacuum if there is no main drain) to allow the salt to evenly disperse throughout the pool. The salt display may take 24 hours to respond to the change in salt concentration.

Always check stabilizer (cyanuric acid), when checking salt. These levels will most likely decline together. Use the chart below to determine how much stabilizer must be added to raise the level to 80 ppm.

POUNDS and (Kg) OF STABILIZER (CYANURIC ACID) NEEDED FOR 80 PPM

Current Stabilizer Level (ppm)	Gallons and (Liters) of Pool/Spa water															
	8,000 (30000)	10,000 (37500)	12,000 (45000)	14,000 (52500)	16,000 (60000)	18,000 (67500)	20,000 (75000)	22,000 (82500)	24,000 (90000)	26,000 (97500)	28,000 (105000)	30,000 (112500)	32,000 (120000)	34,000 (127500)	36,000 (135000)	38,000 (142500)
0 ppm	5.3 (3.6)	6.7 (4.3)	8.0 (3.6)	9.4 (4.3)	10.7 (4.9)	12.0 (5.4)	13.4 (6.1)	14.7 (6.7)	16.0 (7.3)	17.3 (7.9)	18.7 (8.5)	20.0 (9.1)	21.3 (9.7)	22.7 (10.3)	24.0 (10.9)	2.0 (.9)
10 ppm	4.7 (3.2)	5.8 (3.7)	7.0 (3.2)	8.2 (3.7)	9.4 (4.3)	10.5 (4.8)	11.7 (5.3)	12.9 (5.9)	14.0 (6.4)	15.2 (6.9)	16.4 (7.4)	17.2 (8.0)	18.7 (8.5)	19.8 (9.0)	21.0 (9.5)	2.0 (.9)
20 ppm	4.0 (2.7)	5.0 (3.2)	6.0 (2.7)	7.0 (3.2)	8.0 (3.6)	9.0 (2.2)	10.0 (4.5)	11.0 (5.0)	12.0 (5.4)	13.0 (5.9)	14.0 (6.4)	15.0 (6.8)	16.0 (7.2)	17.0 (7.7)	18.0 (8.1)	1.0 (.4)
30 ppm	3.3 (2.3)	4.2 (2.7)	5.0 (2.3)	5.9 (2.7)	6.7 (3.0)	7.5 (3.4)	8.4 (3.8)	9.2 (4.2)	10.0 (4.5)	10.8 (4.9)	11.7 (5.2)	12.5 (5.6)	13.3 (6.0)	14.2 (6.3)	15.0 (6.7)	1.0 (.4)
40 ppm	2.7 (1.8)	3.3 (2.1)	4.0 (1.8)	4.7 (2.1)	5.4 (2.4)	6.0 (2.7)	6.7 (3.0)	7.4 (3.3)	8.0 (3.6)	8.7 (3.9)	9.3 (4.2)	10.0 (4.5)	10.7 (4.8)	11.3 (5.1)	12.0 (5.4)	1.0 (.4)
50 ppm	2.0 (1.4)	2.5 (1.6)	3.0 (1.4)	3.5 (1.6)	4.0 (1.8)	4.5 (2.0)	5.0 (2.3)	5.5 (2.5)	6.0 (2.7)	6.5 (2.9)	7.0 (3.2)	7.5 (3.4)	8.0 (3.6)	8.5 (3.9)	9.0 (4.1)	1.0 (.4)
60 ppm	1.3 (.91)	1.7 (1.1)	2.0 (.91)	2.3 (1.1)	2.7 (1.2)	3.0 (1.4)	3.3 (1.5)	3.7 (1.7)	4.0 (1.8)	4.3 (2.0)	4.7 (2.1)	5.0 (2.3)	5.3 (2.4)	5.7 (2.6)	6.0 (2.7)	1.0 (.4)
70 ppm	0.7 (.45)	0.8 (.54)	1.0 (.45)	1.2 (.54)	1.4 (.64)	1.5 (.68)	1.7 (.77)	1.8 (.82)	2.0 (.91)	2.2 (1.0)	2.3 (1.1)	2.5 (1.2)	2.7 (1.2)	2.8 (1.3)	3.0 (1.3)	1.0 (.4)
80 ppm	0.0	0.0	0.0	0.0	0.0	0.0	0.0	0.0	0.0	0.0	0.0	0.0	0.0	0.0	0.0	0.0

2. Mounting the Equipment

Aqua Logic Control Center

The Aqua Logic is contained in a raintight enclosure that is suitable for outdoor mounting. The control must be mounted a minimum of 5 ft. (2 meters) horizontal distance from the pool/spa (or more, if local codes require). The Control Center is designed to mount vertically on a flat surface with the knockouts facing downward. Because the enclosure also acts as a heat sink (disperses heat from inside the box), it is important not to block the four sides of the control. Do not mount the Aqua Logic inside a panel or tightly enclosed area.

When selecting a location, note that the standard cables supplied with the Turbo Cell, flow switch, temperature sensors, and valve actuators (if applicable) are all 15 ft. (5m) long. Call the Goldline Service Dept. (888-921-7665) for information regarding longer cables.

Temperature Sensors

The water temperature sensor is required for proper operation of the heater control and/or solar control functions. This sensor is used to measure the pool water temperature when the pool/spa suction valve is switched to the “pool” position and measures the spa water temperature when the valve is switched to the “spa” position. The sensor should be installed in the filtration plumbing after the filter but before either the solar or conventionally fueled heaters—refer to the plumbing overview diagram.

1. Drill a 3/8” (10mm) diameter hole in the PVC piping and remove all chips and burrs.
2. Insert sensor until O-ring collar sits flush on the hole.
3. Position hose clamp over the sensor and gently tighten until O-ring makes an adequate seal. Do not overtighten.
4. For maximum temperature accuracy, cover the sensor and 3” (6cm) of pipe on either side with insulation and paint white.

Also, if the freeze protection option is selected for the filter pump or any aux output, the air sensor is used to detect freeze conditions.  **IMPORTANT: Mount the air sensor out of direct sunlight.**

The solar sensor (order separately) is required only for the solar control function. Mount the sensor near the solar collector array so that it is exposed to the same sunlight as the collectors. Use additional cable (20 AWG) if necessary.

Optional AQL-CL Chlorination Kit

The AQL-P4 and AQL-PS-4/8/16 models require the use of the AQL-CL or AQL-CL-25FT chlorination kit when using the chlorinator function. This kit contains a Turbo Cell, cell unions and flow switch. Refer to pages 9 and 18 for plumbing and wiring instructions.

Optional Remote Display/Keypad

The Aqua Logic Remote Display/Keypad (Goldline part number AQL-WMW-P4 must be mounted indoors or in a weather protected area (rain should never hit the display/keypad). Up to 3 remote display/keypads (1 supplied with Aqua Logic, order additional remote display/keypads separately) can be installed. The display/keypad is designed to mount onto a standard electrical utility box (ideal for new construction) or can be mounted directly onto any wall surface. When selecting a location, note that the wire to the Aqua Logic main unit must be less than 500’ long. Follow the steps below:

1. Remove display/keypad baseplate from the cover by lifting up on the cover at the lower end of the keypad. See diagram on page 7.

2. Screw the baseplate in the desired position (screws supplied by installer).

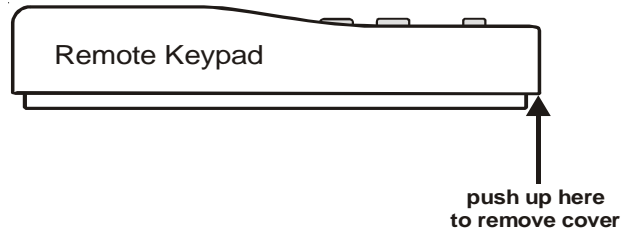

3. See "Electrical Wiring" (page 17) for instructions on running the cable from the Aqua Logic main unit to the remote display/keypad.

Optional Base Receiver

The optional base receiver (Goldline part number AQL-BASE-RF) must be installed if the wireless spaside remote is used. To install the base receiver, remove the knockout on the upper left side of the Aqua Logic main control unit, insert the base receiver, and then tighten the nut from the inside. Also refer to the Base Receiver manual and the diagram on page 17.

Optional Valve Actuators

For optional actuators supplied with the Aqua Logic—note that the internal cams in the actuator may also have to be adjusted depending on the way the actuator is mounted on the valve and the desired valve action.

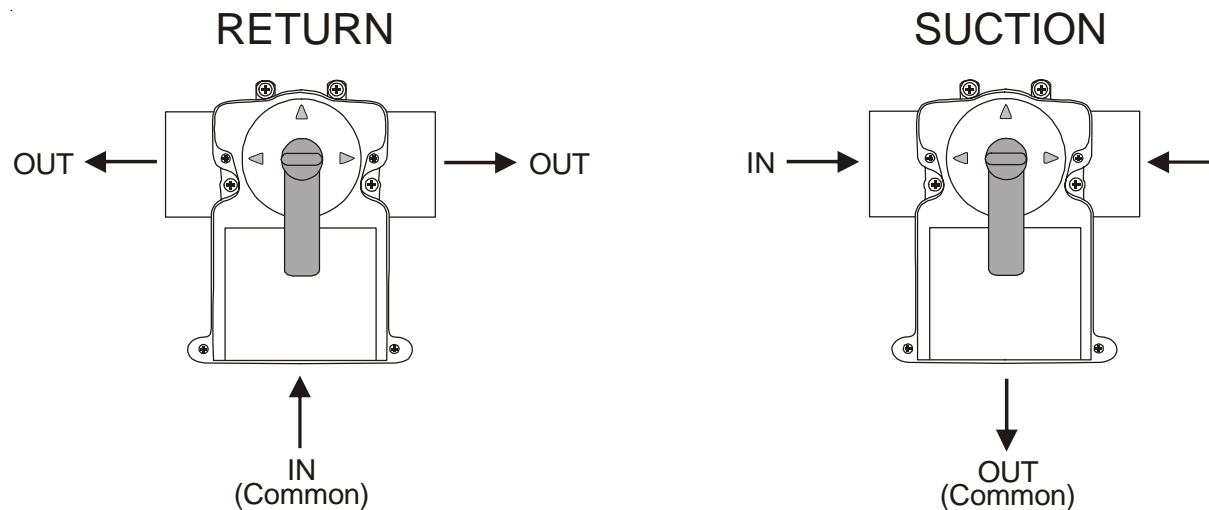

3. Plumbing

“Standard” Pool/Spa system configuration

These systems use a single filter pump and filter. Pool or spa operation is controlled by two 3-way valves (suction and return). Refer to the diagram below.

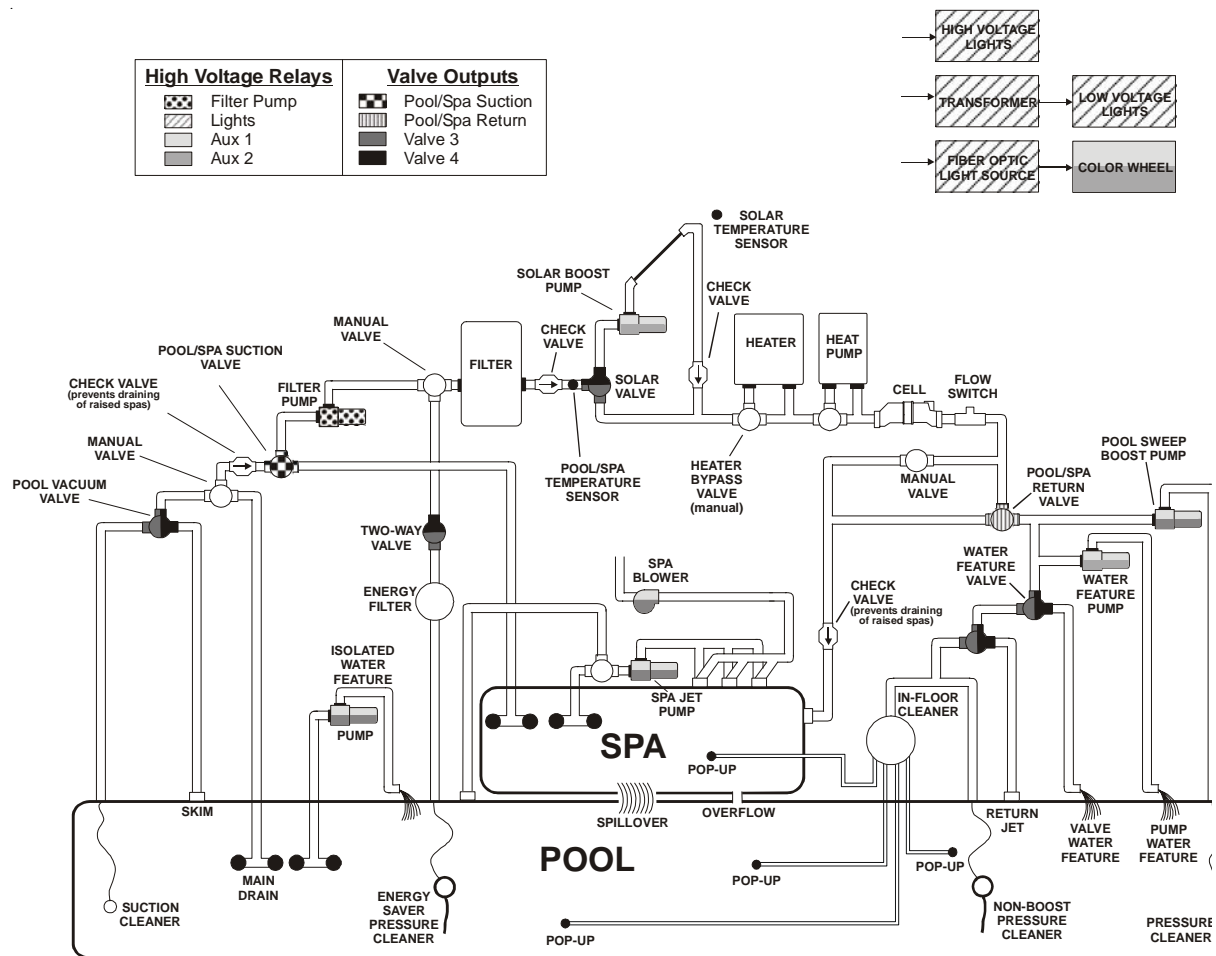

Some important notes regarding the Aqua Logic control of Standard Pool/Spa systems:

In Pool/Spa Config., select:

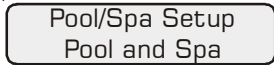

1. The Aqua Logic can be programmed to accommodate spa spillover, if desired.
2. A conventional heater (gas or heatpump) and solar can be used to heat both the pool and the spa.
3. If the chlorinator cell is plumbed prior to the pool/spa return valve, then both the pool and the spa can be chlorinated
4. The water sensor should be installed prior to any heater or solar and will display either the pool or the spa temperature, depending on the current operation of the pool. The temperature will only be displayed when the filter pump is running.
5. If any water feature or pressure side cleaner boost pumps are used, be sure to enable the “interlock” feature (see “Configuration Menu” for details) to ensure that the pumps operate only when the filter pump is on and the system is in the “pool only” operating mode.
6. The plumbing diagram above is intended to be used as a general guideline and is not a complete plumbing schematic for the pool.
7. The air sensor must installed if the freeze protection feature is enabled for the filter, valves or aux outputs.

Turbo Cell (supplied with AQL-CL chlorination kit)

The Turbo Cell (used for chlorine generation) should be plumbed AFTER the filter and heater. If installed on a pool/spa combination system, the cell should be plumbed BEFORE the pool/spa return valve in order to allow proper chlorination of both the pool and the spa. Refer to plumbing diagram below:

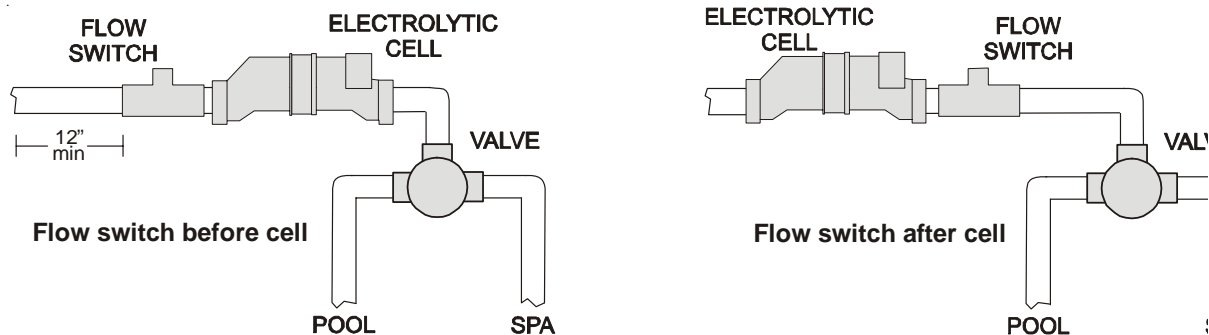

The cell may be mounted vertically or horizontally, and water can move in either direction through the cell. Install using the 2" unions provided. Tighten unions **BY HAND** for a watertight seal. For systems with 1½" plumbing use adaptors (provided by installer).

Flow Switch (supplied with AQL-CL chlorination kit)

The flow switch must be plumbed in the same section of plumbing as the Turbo Cell. The flow switch is a safety device that ensures that water is flowing through the cell before the Aqua Logic starts to generate chlorine. Failure to properly install the flow switch can result in explosive gases accumulating in the pool plumbing system.

⚠ IMPORTANT: There must be at least a 12" (30cm) straight pipe run before (upstream) the flow switch. If the switch is plumbed after the cell, the cell can be counted as the 12" (30cm) of straight pipe.

⚠ IMPORTANT: To ensure proper operation, verify that the arrow on the flow switch points in the direction of water flow.

4. Electrical Wiring

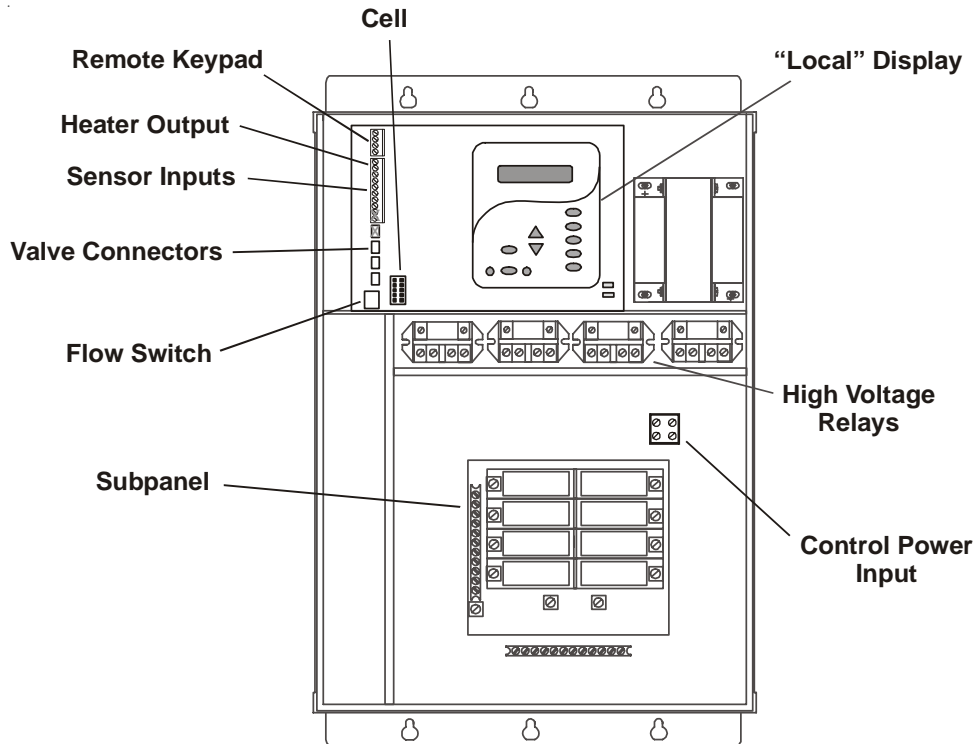

The Aqua Logic Control Center requires both high and low voltage connections. Low voltage connections will be made to actuators, sensors, remote keypad, etc. High voltage connections will be made to pumps, lights, etc., as well as providing direct input power to the Control Center. Always:

- Ensure that Power is disconnected prior to doing any wiring
- Follow all local and NEC (CEC if applicable) codes
- Use copper conductors only

Main Service (Power to the Circuit Breaker Subpanel)

The Aqua Logic circuit breaker subpanel is rated for 100A service. Run properly rated conductors (L1, L2, N, and ground) from the primary house electrical panel to the main power connections on the Aqua Logic circuit breaker base. The connection at the main house panel should be to a 240VAC circuit breaker rated at 100A maximum.

Grounding and Bonding

Connect a ground wire from the primary electrical panel to the Aqua Logic ground bus bar. Also ground each piece of high voltage (120 or 240VAC) equipment that is connected to the Aqua Logic control relays or circuit breakers. The Aqua Logic should also be connected to the pool bonding system by an 8AWG (6AWG for Canada) wire. A lug for bonding (2 for Canada) is provided on the outside/bottom of the Aqua Logic enclosure.

Circuit Breaker Installation and Wiring

Circuit breakers are to be supplied by the installer. Refer to the circuit breaker chart on the following page for a list of suitable circuit breakers that can be used. Follow the code and the circuit breaker manufacturer's rating requirements regarding the size and temperature rating for wiring. Note that some pool equipment may be required to be connected to ground fault circuit breakers—check local and NEC (CEC) codes.

SUITABLE LISTED BREAKERS						
Manufacturer	Single	Double	Twin	Quad	GFCB	Filler Plates
Cutler-Hammer	BR	BR	BRD	BRD	GFCB	BRFP
Murray	MP-T	MP-T	MH-T	MH-T	MP-GT	LX100FP
Siemens	QP	QP	QT	QT	QPF	QF3
Square D	HOM	HOM	HOMT	HOMT	HOM	HOMFP
Thomas & Betts	TB	TB	TBBD	TBBQ	GFB	FP-1C-TB

General Purpose Outlet

If desired, a duplex receptacle with weatherproof cover (supplied by installer) may be installed in the knockouts on the lower right side of the Aqua Logic enclosure. Per code, the receptacle should be a GFCI type. Alternatively, connect a standard receptacle to a GFCB.

Aqua Logic Control Power

The Aqua Logic requires 120VAC, 2A power to operate the control logic circuits and the chlorinator. This power should be connected to one of the circuit breakers.

⚠ WARNING: 120VAC only (permanent damage if connected to 240V)

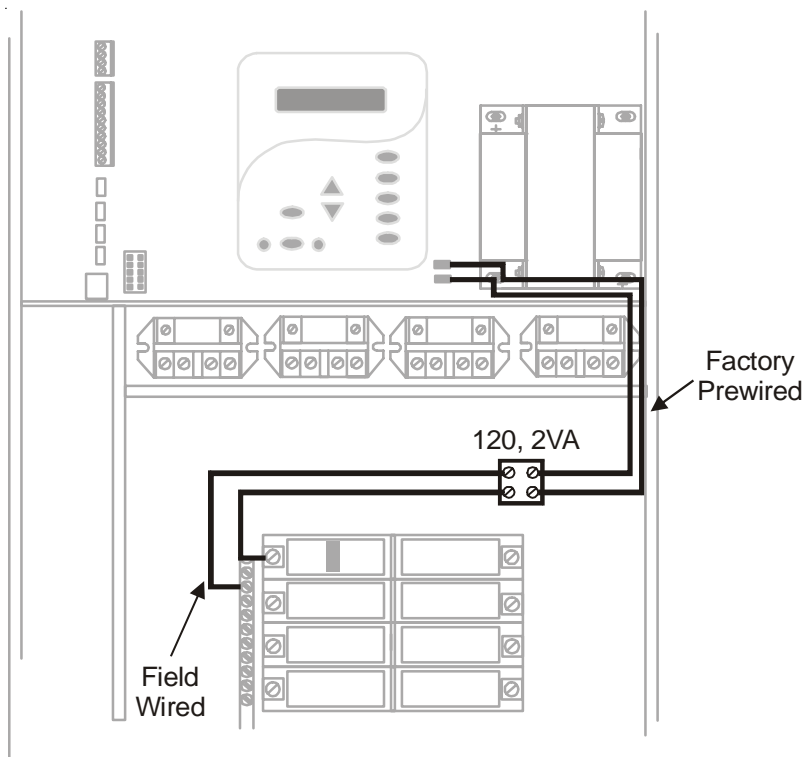

High Voltage (120/240V) Pool Equipment

All Aqua Logic relays are double pole (they make/break both “legs” of 240V circuits) and are rated at 3HP/30A at 240V (1½HP/30A at 120V). Refer to the diagram below for typical relay wiring.

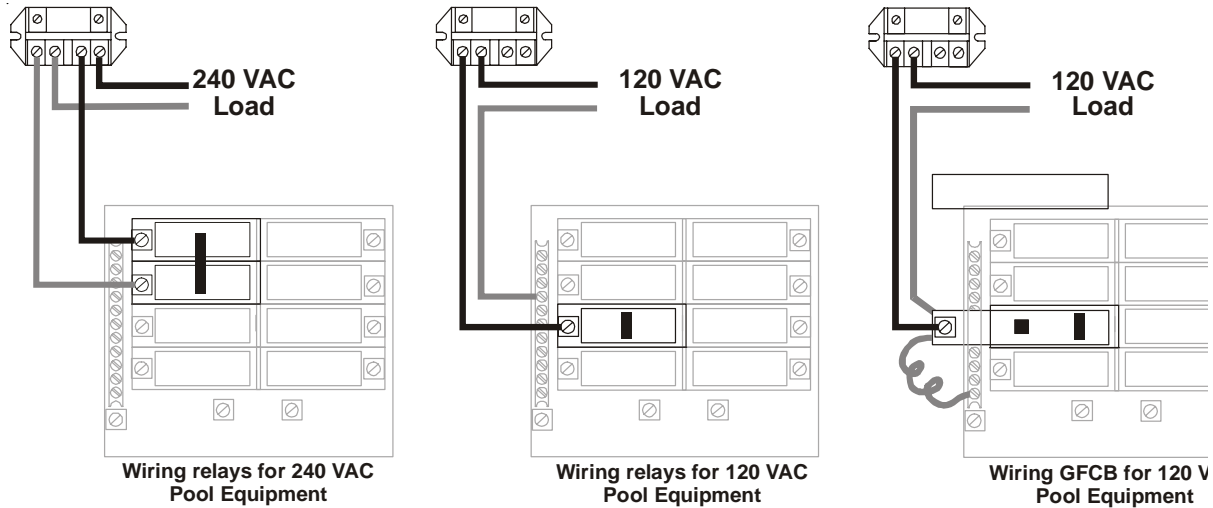

⚠ WARNING: Do not use the Aqua Logic to control an automatic pool cover. Swimmers may become entrapped underneath the cover.

Two speed filter pump: Requires 2 relays (FILTER plus one of the AUX relays) for proper operation of both speeds. **⚠ IMPORTANT:** Be sure to follow the wiring diagram below AND to configure the control logic according to the instructions on page 21.

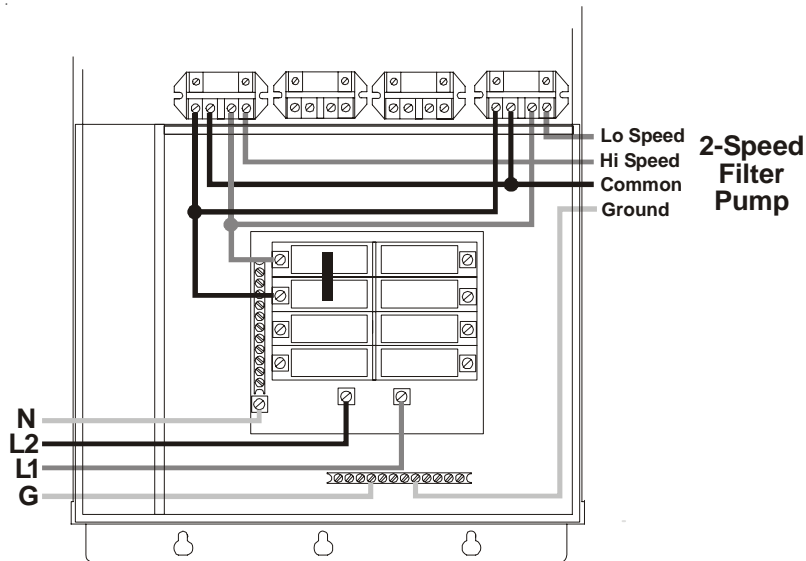

Lights: A ground fault circuit breaker must be used to supply power for high voltage pool/spa lighting. Low voltage lights will require an external transformer. For lighting systems that have both a light source and color wheel, connect the light source to the “Lights” relay and then connect the color wheel to one of the AUX outputs.

Low Voltage Wiring

Valve Actuators

The Aqua Logic can control up to four (PS-4/8) or eight (PS-16) 24V automatic valve actuators. Two of the valve outputs are dedicated to the pool/spa suction (Valve2) and return (Valve1) valves. Valve3 is for general purpose use (solar, water feature, in-floor cleaner, etc.).

For installations with solar heating, Goldline offers the AQ-SOL-KIT-xx solar kit that contains a valve, actuator, and extra temperature sensor. The “xx” indicates the valve type from the 3 choices below:

- 1P 1.5” Positive Seal
- 2P 2” Positive Seal

The Aqua Logic is compatible with standard valve actuators manufactured by Jandy, Pentair/Compool, and Hayward. See diagram on page 10 for the location of valve connectors.

Heater Control

The Aqua Logic provides a set of low voltage dry contacts that can be connected to most gas heaters or heatpumps with 24V control circuits. Refer to the diagram below for a generic connection. The manuals supplied with most heaters also include specific wiring instructions for connecting the heater to an external control (usually identified as “2-wire” remote control). For millivolt or line voltage heaters, contact Goldline Tech support, 888-921-7665. Refer to the diagrams and the information on the following pages for more details on the connection to several popular heaters.

Generic Heaters

1. Wire heater to 120/240V power source per the instructions in the heater manual. The Aqua Logic does NOT control the power going to the heater.
2. Wire the Aqua Logic dry contact heater output per the diagram below. Many internal parts of the heater can get very hot--see the heater manufacturer’s recommendations on the minimum temperature rating for wires. If no guidance is given, use 105°C rated wire.
3. Set any ON/OFF switch on the heater to ON.
4. Set the thermostat(s) on the heater to the maximum (hottest) setting.

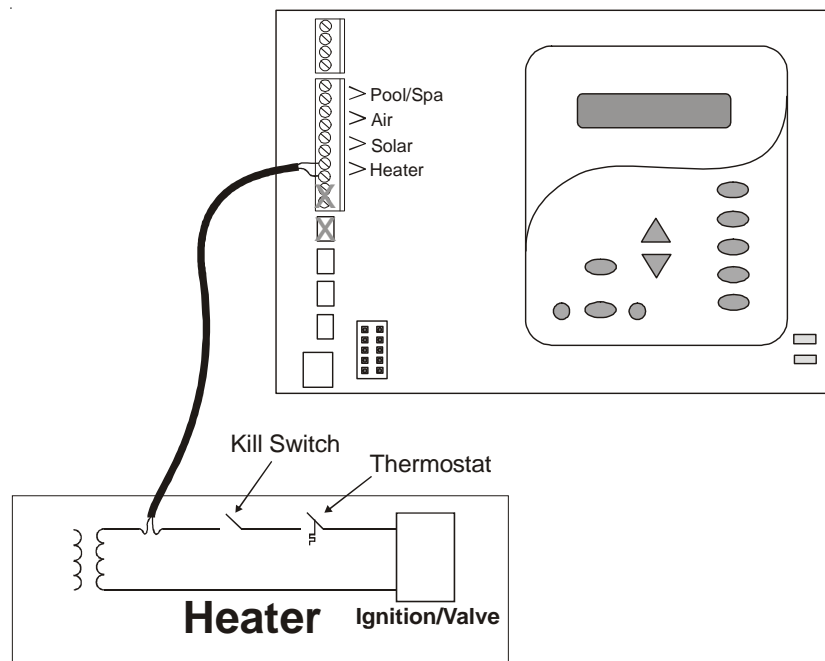

Laars Heaters

1. Turn power off to heater.
2. Remove factory jumper from terminal block.
3. Wire Aqua Logic to the heater as shown.
4. Ensure toggle switch is in the ON position.
5. Set heater thermostats to maximum position.

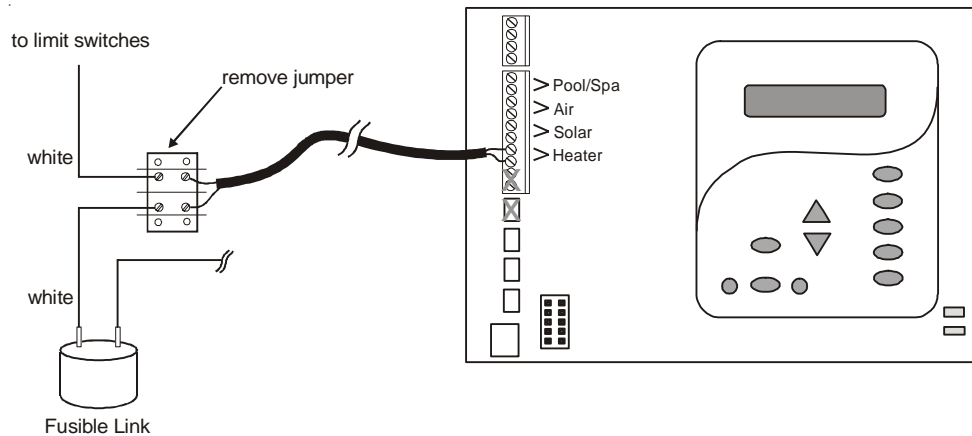

Hayward Heaters

Refer to the instructions in the heater manual for “2-wire Remote Thermostat” operation under “Remote Control Connections” and the diagram below:

1. Turn off power to heater.
2. Wire Aqua Logic to terminals 1 & 2 (see diagram).
3. Leave jumper attached to terminals 4 & 5.
4. Move “BYPASS” dipswitch on heater circuit board to “ON” position (up).
5. Turn heater power back on.
6. Switch heater to either “Pool” or “Spa” (it doesn’t make any difference which is selected, the Aqua Logic will take control).
7. Heater display should be “bO” (for “byo”).
8. Heater will fire whenever Aqua Logic requests (when Aqua Logic “Heater” LED is illuminated).

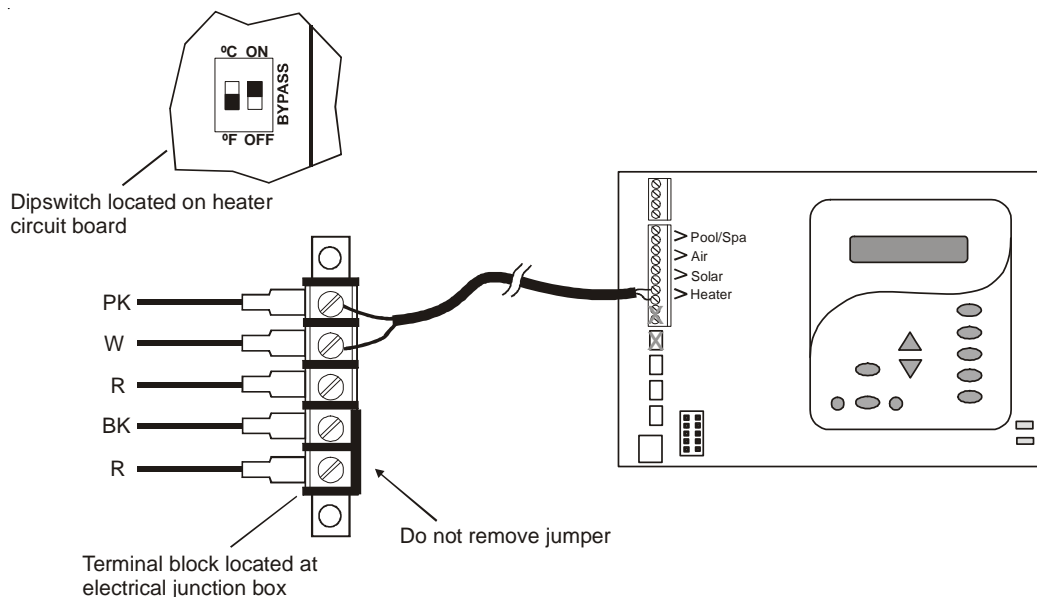

Pentair/Purex/MiniMax

1. Turn power off to heater.
2. Remove factory installed jumper from the “Ext Switch” connector.
3. Wire the Aqua Logic to the “Ext Switch” connector as shown below.
4. The wires to the Aqua Logic must be separated from any line voltage wires. Failure to follow these instructions may cause erratic operation of the heater.
5. Set the Power (Thermostat Select) switch to either “Pool” or “Spa”.
6. Set the “Pool” and “Spa” thermostats to their maximum settings.

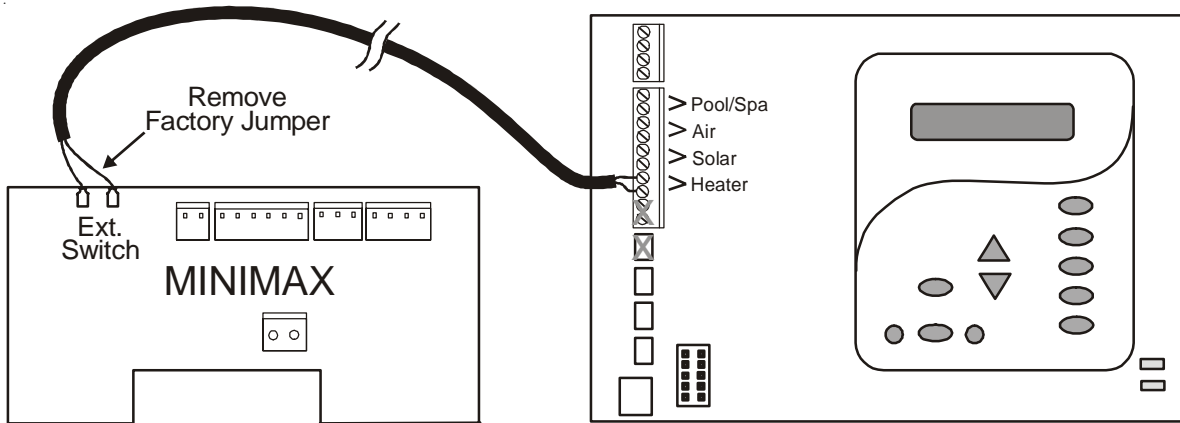

Raypak RP2100 Pool/Spa Heater

1. Turn power off to heater.
2. Push the mode button to “spa” mode.
3. Set the temperature to the maximum.
4. Push the mode button to “OFF”.
5. Lastly, plug the prewired connector in the P7 position on the board.

⚠ IMPORTANT: The heater will display “OFF” when it is being remotely controlled by the Aqua Logic. Some homeowners see the “OFF” display and, thinking this is a mistake, change the mode to “POOL” or “SPA” which then disables the remote control by the Aqua Logic. To prevent this: Remove the heater touch pad connector (P5) which will disable the touchpad.

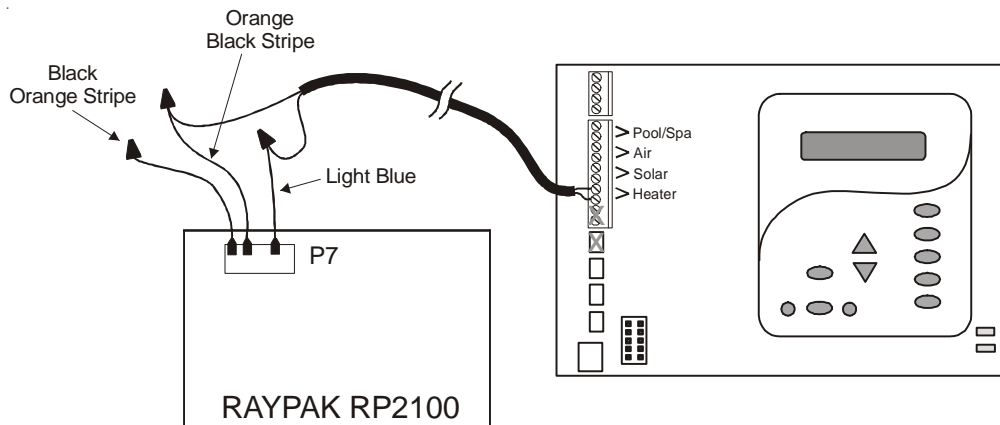

Drawing is for dig heater. If heater millivolt (analog) run red wires from Fireman's Switch to heater relay.

STA-RITE Heater

1. Turn power off to heater.
2. Remove upper jacket and open the control box.
3. Remove the jumper for the “fireman’s switch.
4. Wire to the Aqua Logic using wire rated for 105°C minimum.

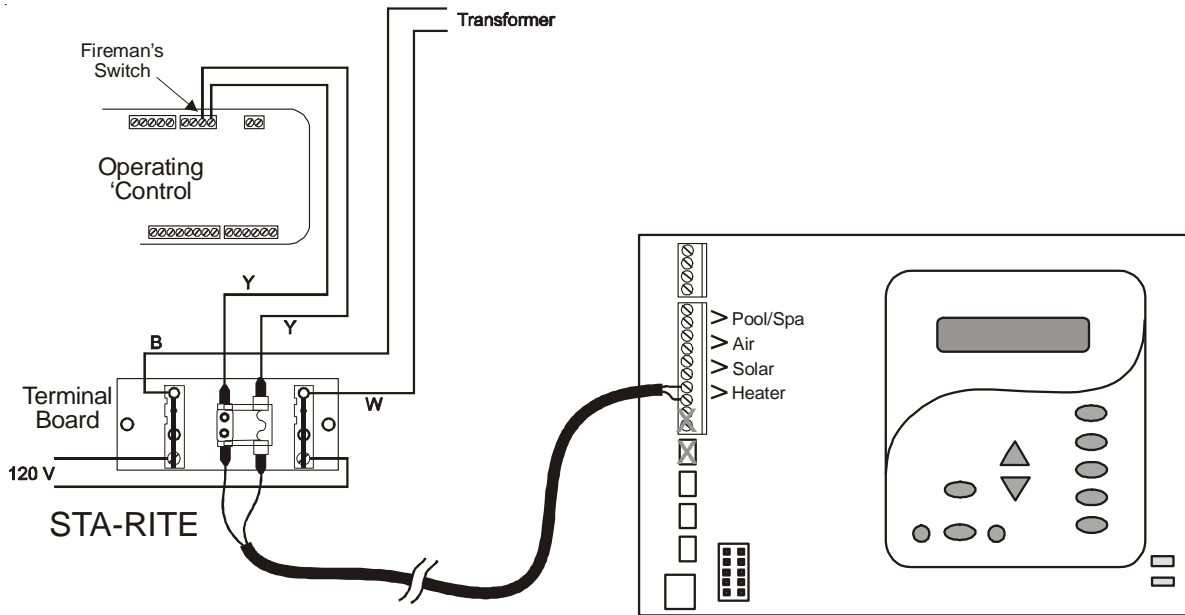

Temperature Sensors

The Aqua Logic utilizes 10K ohm thermistor type sensors. Three sensors (water temperature, air temperature and solar temperature) are included. If the Aqua Logic is being used to control a solar heating system, a third “solar” sensor will be required. The sensors are provided with a 15 ft. cable. If a longer cable is required, contact the Goldline service dept. (888-921-7665) for information on suitable cable types and splices. See Temperature Sensors on page 6 for directions on installing the sensors.

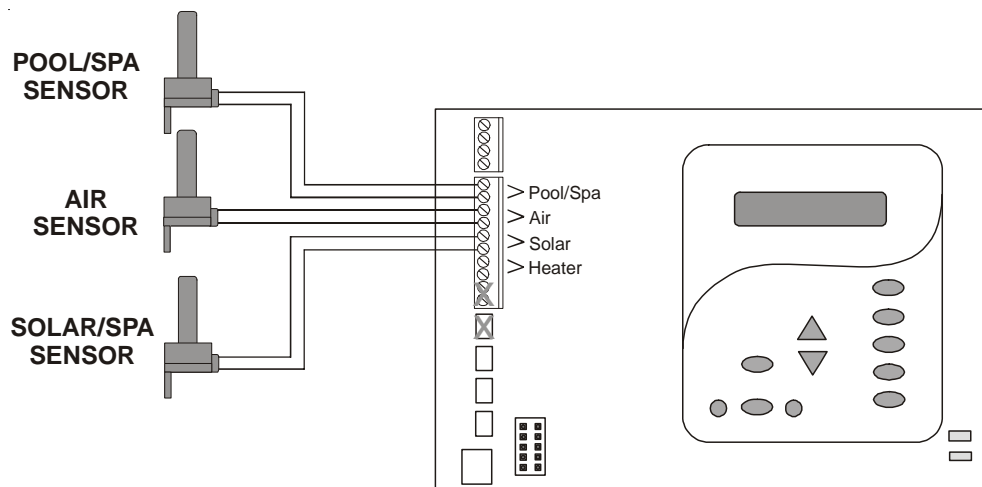

Remote Display/Keypad

The Aqua Logic main unit can connect to a maximum of 3 remote wired display/keypads (ordered separately).

Use four conductor cable (typically phone cable) to connect the wired remote display/keypad with the Aqua Logic Control Center as shown below. The maximum wiring distance is 500ft. (160m). Note that the terminals on both the Aqua Logic main unit and the wired remote display/keypad are numbered: Connect 1 to 1, 2 to 2, etc. Refer to diagram below.

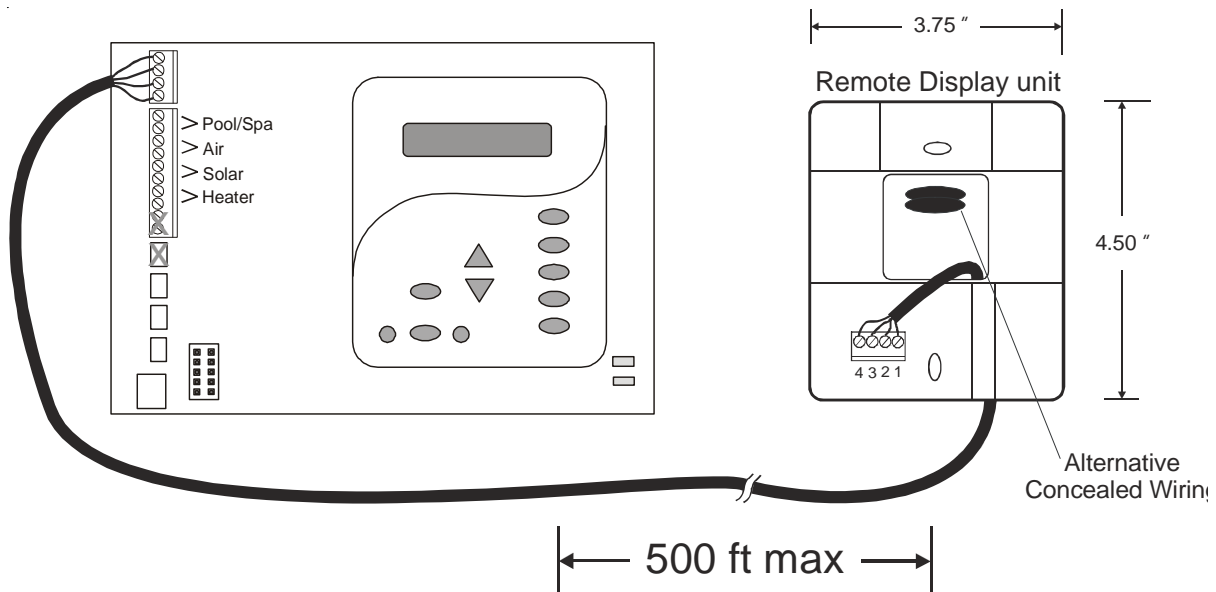

If multiple remote display/keypads are installed: Never connect more than 2 wires to any terminal block. Two remotes can be wired back to the Aqua Logic main unit or the second display/keypad (and third, if applicable) can be “daisy chained” with one display/keypad wired to the next. The maximum wire run from the Aqua Logic main unit to the furthest remote display/keypad is 500 ft (160m).

Base Receiver

Plug in the pigtail connector from the wireless base receiver into the “wireless” connector on the main PCB in the Aqua Logic control unit.

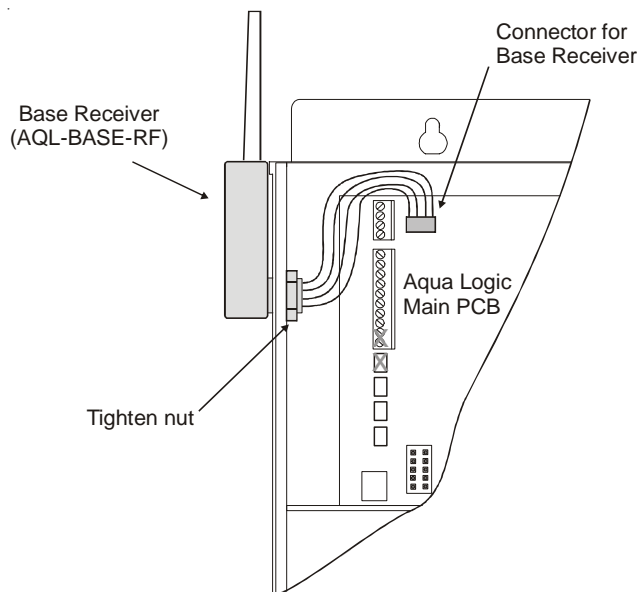

Flow Switch

Only applicable if the chlorinator function is enabled. The flow switch cable plugs into the Aqua Logic Control Center at the position shown in the diagram on page 10. Ensure that the connector catch “snaps” in order to provide a reliable connection.

Turbo Cell

Only applicable if the chlorinator function is enabled. The Turbo Cell should be plugged in after the Aqua Logic cover panel is put back in place. Refer to page 10 for the location of the connector.





5. Configuration Setup

After plumbing and wiring are complete, the Aqua Logic **MUST BE CONFIGURED** before attempting to operate. Configuration information is entered at the keypad and “tells” the Aqua Logic what equipment is connected and how each should be controlled.

Accessing the Configuration Menu

Configuring the Aqua Logic requires that you navigate through the Configuration Menu and input various information. For more detailed information about using the Aqua Logic menu system, refer to the Operation Manual.









To access the Configuration Menu

Configuration Menu-Locked	 Press repeatedly until “Configuration Menu” is displayed
	  Press BOTH buttons SIMULTANEOUSLY for 5 seconds to unlock
Configuration Menu-Unlocked	  Move to configuration menu items

NOTE: The configuration menu automatically “locks” after 2 minutes of no buttons being pressed to prevent unauthorized people from changing the control logic inadvertently and possibly damaging the pool equipment or causing a “call back” to fix the configuration.

Configuration Menu Items

Each item needs to be programmed and may contain additional sub-menu items. Refer to the following pages for information on programming.













Chlor. Config. + to view/change	 Push to access Chlorinator option
	  Move to previous/next configuration menu item
Chlorinator Disabled	 Toggle between Chlorinator Enabled and Disabled (default)
	  Move to previous/next configuration menu item
Display Salt	 Toggle between Display Salt (default) and Minerals
	  Move to previous/next configuration menu item

Chlorinator

If the chlorinator is enabled (requires the use of the AQL-CL chlorination kit), then the cell and flow switch must also be installed and the Aqua Logic will automatically chlorinate both the pool and spa according to the desired output setting (see Settings Menu in the Operation manual). If disabled (default), then neither the cell nor flow switch need to be installed and all displays relating to the chlorinator will be suppressed.

Display

Allows for the display of salt (default) or mineral values.

Pool/Spa Config. + to view/change	 Push to access Pool/Spa options  Move to previous/next configuration menu item
Pool/Spa Setup Pool and Spa	 Rotates between Pool and Spa, Spa Only, and Pool Only (default) optic  Move to next menu item
<i>if "Pool and Spa" is selected</i>	
Spa - CountDn 00:30	 Adjust time setting (Manual on/off, 0:05, 0:10, 0:15..., (default is 4:00))  Move to next menu item
<i>if "Pool and Spa" is selected</i>	
Spa Spillover Enabled	 Toggle between Enabled and Disabled (default) Spa Spillover  Move to next menu item
<i>if "Pool and Spa" is selected and if "Spa Spillover" is enabled</i>	
Filter Operation Spa Spillover	 Toggle between Pool Only (default) and Spa Spillover options  Move to next menu item
<i>if "Pool Only" or "Spa Only" is selected</i>	
V1=Aux1, V2=Aux2 Disabled	 Toggle between Enabled and Disabled (default)  Move to next menu item

Pool/Spa Setup

If "Pool Only" or "Spa Only" are selected, then the pool/spa valves are deactivated and pushing the POOL/SPA button on the display/keypad will have no effect. If "Pool and Spa" is selected, then the pool/spa suction and return valve actuators should be connected to the Aqua Logic. Pressing the POOL/SPA button on the display/keypad will allow the homeowner to alternate between pool and spa operation. For more information on "Pool and Spa", refer to the Plumbing section on pages 8-9.

Spa CountDn

This menu will appear only if Pool/Spa Setup is set to "Pool and Spa". This setting is the time, after you manually switch the Pool/Spa valves to "Spa Only", until the Aqua Logic automatically returns the valves to their previous positions. It is programmed in increments of 5 minutes, from "Manual On/Off" (0 minutes) to "21:00" (21 hours). The filter is forced on during this time period.

Spa Spillover

When spa spillover is "Enabled" and "Pool and Spa", the homeowner will be able to rotate through "Pool Only" (both suction and return valves switched to pool), "Spa Only" (both suction and return valves switched to spa) and "Spillover" (suction valve switched to pool and return valve switched to spa) by successive presses of the "Pool/Spa" button.

Filter Operation

If "Spa Spillover" is selected, the Aqua Logic will automatically switch the pool/spa suction and return valves to the "spillover" at the start of the programmed pool filtering time period or when the superchlorinate function is turned on. The valves will remain in this position for the remainder of the superchlorinate period. This option is usually preferable because both the pool and spa water will be filtered and sanitized.

If "Pool Only" is selected, then the Aqua Logic will switch the pool/spa valves to the "pool only" position during super chlorinate. This may be desirable on some systems with in-floor cleaners because it allows the cleaner to operate all the time the pool is being filtered and/or the super chlorinate is running.

V1=Aux1, V2=Aux2

This menu appears only if the Pool/Spa Setup is "Pool Only" or "Spa Only". When enabled, Valve 1 (return) will follow the Aux1 output and Valve 2 (suction) will follow the Aux2 output.

When disabled (default), the return and suction pool/spa valves function normally.

Filter Pump Config. + to view/change	▲ Push to access pump options ◀▶ Move to previous/next configuration menu
Filter Pump 1 Speed	▲▼ Toggle between 1-speed (default) and 2-speed options ◀▶ Move to next menu item
Freeze Protect Enabled	▲▼ Toggle between Enabled (default) and Disabled Freeze Protection ◀▶ Move to next menu item
Freeze Temp 38°F	▲▼ Adjust the desired freeze protection temperature (33°F - 42°F) ◀▶ Move to next menu item

Filter Pump

Select single speed or 2-speed pump. If a 2-speed pump is configured, one of the AUX relays must also be configured to control the low speed motor winding on the pump (see page 12 for wiring and page 23 for AUX configuration). See the Operation Manual for specific information regarding the control logic for 2-speed pump operation.

Freeze Protection

Freeze protection is used to protect the pool and plumbed equipment against freeze damage. If freeze protection is enabled and the AIR temperature sensor falls below the freeze threshold (see below), the Aqua Logic will turn on the filter pump to circulate the water. If “Pool and Spa” is selected in the Pool/Spa sub-menu (see page 20), the valves will also alternate between the pool and spa every 30 minutes and the filter pump will turn off while the valves are turning. The heater and chlorinator will not operate if freeze protection is the only reason the pump is running.

Freeze Protection Temperature

Select the temperature to be used for freeze protection. Temperature is adjustable from 33°F - 42°F (1°C - 6°C). 38°F (3°C) is default. This threshold will be used for all outputs that have freeze protection enabled.

Heater1 Config. + to view/change	▲ Push to access heater options ◀▶ Move to previous/next configuration menu
Heater1 Disable	▲▼ Toggle between Enabled and Disabled (default) Heater 1 ◀▶ Move to next menu item
<i>if “Heater1” is enabled</i> Heater1 Cooldown Disabled	▲▼ Toggle between Enabled and Disabled (default) Heater 1 Cooldown ◀▶ Move to next menu item
<i>if “Heater1” is enabled</i> Heater1 Extend Disabled	▲▼ Toggle between Enabled and Disabled (default) Heater 1 Extend ◀▶ Move to next menu item

Heater1

If the heater is “Enabled”, the heater relay will turn on when the water temperature is less than the desired temperature setting and the filter pump is running. The desired temperature is in the “Settings Menu”. If applicable, the homeowner will be prompted to enter separate “pool” and “spa” settings. Depending on the position of the pool/spa suction valve, the proper temperature setting will be used.

Heater Cooldown

This feature ensures that the heater cools down before water circulation is stopped. When enabled, The Aqua Logic will continue to run the filter pump for 15 minutes after the heater turns off. During this period the filter pump LED will flash and also a “Heater Cooldown, Filter Pump On” message will scroll on the display.

When the filter pump is running and the heater is on: Pressing the “Filter” button once will cause the heater to turn off, but the filter pump will continue to run for heater cooldown (filter LED flashing and message on display). Pushing the filter button a second time will override the heater cooldown operation and turn the filter pump off.

Heater Extend

If “Enabled”, the filter extend logic keeps the filter pump running beyond the normal turn-off time until the pool (or spa) is heated up to the desired temperature setting (see Settings Menu). Heater extend will NOT cause the filter pump to turn on, it will only delay the turn off time when the heater is operating.

Solar Config. + to view/change	▲ Push to access solar options ◀▶ Move to previous/next configuration menu
Solar Disabled	▲▼ Toggle between Enabled and Disabled (default) Solar ◀▶ Move to next menu item
<i>if “Solar” is enabled</i> Solar-Extend Disabled	▲▼ Toggle between Enabled and Disabled (default) Solar Extend ◀▶ Move to next menu item
<i>if “Solar” is enabled</i> Solar Priority Disabled	▲▼ Toggle between Enabled and Disabled (default) Solar Priority ◀▶ Move to next menu item

Solar

If the solar control logic is “Enabled”, several additional steps must be taken to ensure proper operation of the solar system. If the solar is operated by a valve, then the Valve3 output must be setup for solar logic (page 24). If the solar is operated by a pump, then one of the AUX relays must be set up for solar logic (page 23). Also, the “solar” temperature sensor must be installed. This sensor is typically mounted near the collector array and is used to sense whether sufficient solar heat is available.

If solar is “Enabled”, the valve or solar pump relay will turn on when the water temperature is less than the desired temperature setting AND the solar sensor is hotter than the water. The desired temperature is in the “Settings Menu”. If applicable, the homeowner will be prompted to enter separate pool and spa desired temperature settings. Depending on the position of the pool/spa suction valve, the proper temperature setting will be used.

Solar Extend

If “Enabled”, the filter extend logic keeps the filter pump running beyond the normal turn-off time if solar heat is still available. When solar heat is no longer available, both the solar valve/pump and filter pump will turn off simultaneously. Solar extend will NOT cause the filter pump to turn on, it will only delay the turn off time when solar is operating.

Solar Priority

If both “Solar Control” and “Heater Control” are enabled, the Solar Priority feature will keep the conventional heater off whenever solar heat is available. This provides the most cost effective way of heating the pool. When solar heat is not available, the conventional heater will operate normally.

Lights Config.
+ to view/change

- Push to access Lights options
- Move to previous/next configuration menu item

Lights Function
Manual On/Off

- Rotates between Manual On/Off (default), Countdown Timer, and Timer
- Move to next menu item

Lights Function

Manual On/Off—the lights relay will alternate between turning on and off when the LIGHTS button is pressed. There is no automatic control logic.

Countdown Timer—the lights relay will turn on when the LIGHTS button is pressed. The lights relay will turn off automatically after a programmed time (see Timers Menu in Operation Manual). The LIGHTS button can also be used to turn the output off.

Timeclock – the lights will turn-on and turn-off at the times set for the lights timeclock in the Settings Menu (see Settings Menu in Operation Manual). The LIGHTS button can also be used to turn the output on and off.

NOTE: The configuration parameters for the Aux2 output is the same as shown below for Aux1.

Aux1 Config.
+ to view/change

- Push to access Aux1 options
- Move to previous/next configuration menu item

Aux1 Function
Manual On/Off

- Rotates between Manual On/Off, Countdown Timer, Timeclock, Solar, a Low speed of a 2-speed pump options
- Move to next menu item

for all functions except solar and low speed of 2-speed filter pump

Aux1 Interlock
Disabled

- Toggle between Enabled and Disabled (default) Aux1 Interlock
- Move to next menu item

Aux1 Freeze
Enabled

- Toggle between Enabled (default) and Disabled Aux1 Freeze
- Move to next menu item

WARNING: Do not use the Aqua Logic to control an automatic pool cover. Swimmers may become entrapped underneath the cover.

Aux1 Function

Manual On/Off (default)—the aux relay will alternate between turning on and off when the aux button is pressed. There is no automatic control logic.

Countdown Timer – the aux relay will turn on when the AUX button is pressed and then will turn off automatically after a programmed time (see Timers Menu, Operation Manual). The AUX button can also be used to turn the output off.

Timeclock – the aux relay will turn-on and turn-off at the times set for the aux1 (aux2) timeclock in the Timers Menu. The AUX button can also be used to turn the output on and off.

Solar – the aux relay operates a solar booster pump which will turn on when the filter pump is running and solar heat is available and the water is less than the desired temperature setting. It is important to note that “Solar Control” must be enabled in the “Solar Config.” menu for proper operation to occur.









Low Speed of a 2-speed Filter Pump – the Aqua Logic will operate the aux relay whenever the low speed operation of the filter pump is required. It is very important that the “2-speed” filter pump option be selected under the “Filter Config.” Menu for proper operation.

Aux1 Interlock

If “Enabled”, this feature will override the function (manual on/off, countdown timer, timeclock) selected above and turn the aux1 or aux2 relay off. This forced off condition occurs when: filter pump is off, first 3 minutes of filter pump operation (allows the pump to prime and get water flowing), when the pool/spa suction return valves are in any position other than “pool only”, for 3 minutes after solar turns on (allows air in the solar panels to be purged). Interlock is not available for solar or low speed filter pump functions.

Aux1 Freeze Protection

This function protects the pool, plumbing, and equipment against freeze damage. If Freeze Protection is enabled and the AIR temperature sensor falls below the selected freeze temperature threshold, the Aqua Logic will turn on the aux relay to circulate the water. IMPORTANT: this only enables operation of the AUX output during freeze--see the “Filter Pump Config.” menu to enable freeze protection for the main circulation system.

Valve3 Config. + to view/change	 Push to access Valve3 options  Move to previous/next configuration menu item
Valve3 Function Solar	 Rotates between Timeclock (default), Solar, and In-Floor Cleaner  Move to next menu item
<i>for all functions except solar</i>	
Valve3 Interlock Disabled	 Toggle between Enabled and Disabled (default) Valve3 Interlock  Move to next menu item
Valve3 Freeze Disabled	 Toggle between Enabled and Disabled (default) Valve3 Freeze  Move to next menu item

Valve3 Function

Timeclock (default) – the valve turns on/off at the times set for the Valve3 timeclock in the Timers Menu (see Operations Manual). The Valve 3 button can also be used to turn the valve output on or off.

Solar – the valve operates when the filter pump is running and solar heat is available and the water is less than the desired temperature setting. Solar heating must be enabled in the “Solar Config. menu for proper operation to occur.

In-Floor Cleaner – the valve switches the water returning to the pool between the in-floor cleaner and the normal return jets which facilitate efficient surface skimming. The valve will operate the in-floor cleaner for the first half of each clock hour and then switch to the jets/skimming for the last half of the hour.



Valve3 Interlock

If “Enabled”, this feature will override the function (timeclock or in-floor cleaner) selected above and turn the valve off whenever the filter pump is off or the pool/spa suction/return valves are set to “spa only” or “spillover” operation. Interlock is not available with solar.

Valve3 Freeze Protection



This function protects the pool and plumbed equipment against freeze damage. If Freeze Protection is enabled and the AIR temperature falls below the selected freeze temperature threshold, the Aqua Logic will turn on the valve to allow circulation of the water. **IMPORTANT:** this only enables operation of the Valve3 output during freeze--see the "Filter Pump Config." menu to enable freeze protection for the main circulation system.

All Timeclocks
7-day



-  Toggle between 7-day (default) and Weekend/Weekday time options
-  Move to previous/next configuration menu item

This selection affects ALL of the timeclock logic in the Aqua Logic. If "7-day" is selected, each timeclock will have one set of turn-on/turn-off settings that operate every day of the week. If "Weekend/Weekdays" option is selected then the user can enter one set of turn-on/turn-off times for the weekend (fixed as Saturday/Sunday) and another set of turn-on/turn-off times for weekdays (Monday through Friday).



Time Format
12 hour AM/PM

-  Toggle between 12 hour AM/PM (default) and 24 hour time format option
-  Move to previous/next configuration menu item



Units
°F and PPM

-  Toggle between °F and PPM (default) and °C and g/L (Metric) options
-  Move to previous/next configuration menu item

Reset Config. to
Default Press +

-  Initiate reset of all configuration parameters
-  Move to previous/next configuration menu item (config not reset)

Are you sure?
+ to proceed

-  Reset all configuration parameters
-  Move to previous/next configuration menu item (config not reset)

Config. reset
Confirmed

-  Move to previous/next configuration menu item (config reset)

Use this function to erase all previous system configuration and reset all configuration parameters back to the factory default values. This function is NOT reversible--be careful.

6. System Startup and Checkout

Before Startup

Before starting the Aqua Logic for the first time, be sure that the following items have been completed:

1. Pool/spa chemicals are within the recommended levels according to the chart on page 3.
2. Pool/spa salt level is between 2700 – 3400 PPM.
3. Properly rated circuit breakers are installed in the Aqua Logic subpanel.
4. All wiring is performed according to NEC and local codes.
5. The Aqua Logic is properly grounded and bonded.
6. The Aqua Logic is properly configured to control all desired functions.

Program Automatic Operation

Refer to the programming flow chart on the back cover of this manual for a listing of the available menus and the items included in each menu.

Settings Menu

Heater and/or solar thermostat settings
Chlorinator settings
Day and Time

Timers Menu

Timeclock and/or Countdown timer settings

Heater Checkout

Follow these instructions to verify that the Aqua Logic is properly controlling the heater.

1. Check that the Aqua Logic is calling for the heater to turn on as indicated by the “Heater” LED being illuminated. If the “Heater” LED is illuminated, go directly to step 2; if not, then check the following:
 - The heater is enabled (Configuration Menu/Heater Config.).
 - The heater temperature setting is at least 2°F greater than the water temperature (Settings Menu / Pool Heater & Spa Heater).
 - The filter pump is running.
 - If the pool has solar heat and the solar priority feature is enabled (Configuration Menu/Solar Config) then solar must be off in order for the heater to fire. The easiest way to force solar off is to go to the Settings Menu / Pool Solar & Spa Solar and temporarily lower the temperature settings below the current water temperature.
2. Check that the heater is running. If not, then check:
 - Power is supplied to the heater.
 - The Aqua Logic control output is properly connected to the heater control (see “Heater Control” wiring, page 13).
 - Some heaters also have internal switches or jumpers that have to be set correctly for remote control operation—refer to the heater manual and also “Heater Control” (page 13).
 - Heater is turned on (“Kill Switch” is in the “ON” position).
 - If a heater bypass valve is installed, check that water is flowing through the heater.
 - The heater temperature setting is set as high as possible (usually 104°F/40°C). Also note that some heatpumps actually have to be set to the lowest possible temperature.

3. Once the heater is running, you can verify the “heater cooldown” feature (optional - see Configuration Menu/Heater Config.) is operating properly:
- Press the “Filter” button once (for 2 speed pumps, this may require 2 pushes of the “Filter” button).
 - The heater should turn off (“Heater” LED off) and the “Filter” LED will flash to indicated heater cooldown is active.
 - The display will periodically indicate that the filter pump is on for heater cooldown and show the minutes remaining.
 - The pump will automatically turn off at the end of the 15 minute heater cooldown period.

For more detailed instructions on control and operation of the Aqua Logic system, refer to the Operation Manual.

Service Mode

Service mode disables all automatic control operation and is intended to be used when servicing the pool system. To enter service mode, push the SERVICE button once on the main unit keypad. This will initially turn all outputs off and then allow you to turn outputs on/off manually at the main display (only). In service mode, the buttons on the optional remote display/keypad and the optional spaside remote will turn outputs off, but will not turn any output on. Heater control outputs and solar control outputs are prevented from turning on if the water temperature exceeds 104°F (40°C).

Pushing the SERVICE button twice will enter a timed service mode. Service operation as described above will continue for 3 hours, then automatically return to normal operation.

Push the SERVICE button once more to exit out of Service mode.

The following statement is applicable if any of the wireless accessories are connected to the Aqua Logic system.

FCC Statement

(Compliance Statement, Part 15.19): This device complies with Part 15 of the FCC Rules. Operation is subject to the following two conditions: (1) This device may not cause harmful interference, and (2) this device must accept any interference received, including interference that may cause undesired operation.

WARNING (Part 15.21): Changes or modifications not expressly approved by the party responsible for compliance could void the user's authority to operate this equipment.

Industry Canada Statement

The term "IC" before the certification/registration number only signifies that the Industry Canada technical specifications were met.

Interference

This equipment has been tested and found to comply with the limits for a Class B digital device, pursuant to Part 15 of the FCC rules. These limits are designed to provide reasonable protection against harmful interference in a residential installation. This equipment generates, uses, and can radiate radio frequency energy and, if not installed and used in accordance with the instructions, may cause harmful interference to radio communications. However, there is no guarantee that interference will not occur in a particular installation. If this equipment does cause harmful interference to radio or television reception, which can be determined by turning the equipment off and on, then the user is encouraged to try to correct the interference by one or more of the following measures:

- Reorient or relocate the receiving antenna
- Increase the separation between the equipment and the receiver
- Connect the equipment into a power source on different circuit than the receiver.

Limited Warranty—Pool Automation & Chlorination Products

10/1/2004

This warranty statement is applicable to all pool automation and chlorination products manufactured by Goldline Controls, Inc. (Goldline) **on or after October 1, 2004**. See the appropriate warranty statement for other Goldline products or for pool automation and chlorination products produced prior to October 1, 2004.

Aqua Rite/Trol/Logic—Residential pools in USA or Canada:

Goldline warrants Aqua Rite, Aqua Trol, and Aqua Logic products (products with Goldline part numbers starting with AQ-RITE-, AQ-TROL-, AQ-LOGIC-, AQL-P-, AQL-PS-, or AQL-CL-) installed on private, residential swimming pools within the USA or Canada to be free from defects in material or workmanship, under normal use and service for **five years** from date of the initial system installation, provided it is installed in accordance with the Goldline installation instructions and specifications provided with the product. If written proof of the date of the initial system installation is not provided to Goldline, the manufacturing datecode on the Aqua Rite, Aqua Trol, or Aqua Logic electronics unit will be the sole determinant of the date of the initial system installation.

If a product is defective, in workmanship or materials and is removed and returned freight prepaid within three (3) years after the date of the initial system installation, Goldline Controls will, at its option, either repair or replace the defective product and return it freight prepaid. If the defective product is returned freight prepaid to Goldline more than three (3) years but within five (5) years of the date of the initial system installation, Goldline, at its option, will either repair or replace the defective product and will charge sixty percent (60%) of the current list price for such repairs or replacements, plus shipping charges. The costs incurred in removal and/or reinstallation of the product are NOT covered under this warranty.

Aqua Rite/Trol/Logic— Commercial pools or any pool outside of the USA or Canada:

Goldline warrants Aqua Rite, Aqua Trol, and Aqua Logic products (products with Goldline part numbers starting with AQ-RITE-, AQ-TROL-, AQ-LOGIC-, AQL-P-, AQL-PS-, or AQL-CL-) installed on commercial pools anywhere or any non-private single family residential pool or any pool outside of the USA or Canada to be free from defects in material or workmanship, under normal use and service for **one year** from date of the initial system installation, provided it is installed in accordance with the Goldline installation instructions and specifications provided with the product. If written proof of the date of the initial system installation is not provided to Goldline, the manufacturing datecode on the Aqua Rite, Aqua Trol, or Aqua Logic electronics unit will be the sole determinant of the date of the initial system installation.

If a product is defective, in workmanship or materials and is removed and returned freight prepaid within one (1) year after the date of the initial system installation, Goldline will, at its option, either repair or replace the defective product and return it freight prepaid. The costs incurred in removal and/or reinstallation of the product are NOT covered under this warranty.

Accessory Products and Replacement parts—any pools, anywhere:

Goldline warrants any replacement parts or accessory products (any pool automation or chlorination product or part with a part number other than AQ-RITE-, AQ-TROL-, AQ-LOGIC-, AQL-P-, AQL-PS-, or AQL-CL-) to be free from defects in material or workmanship, under normal use and service for **one year** from date of the initial system installation, provided it is installed in accordance with the Goldline installation instructions and specifications provided with the product. If written proof of the date of the initial system installation is not provided to Goldline, the manufacturing datecode on the product or part will be the sole determinant of the date of the initial system installation.

If a product is defective, in workmanship or materials and is removed and returned freight prepaid within one (1) year after the date of the initial system installation, Goldline will, at its option, either repair or replace the defective product and return it freight prepaid. The costs incurred in removal and/or reinstallation of the product are NOT covered under this warranty.

Warranty exclusions:

1. Material supplied or workmanship performed by others in the process of installation
2. Damage resulting from improper installation including installation on pools larger than the product rating.
3. Problems resulting from failure to operate the products in accordance with recommended instructions contained in product's owners manual.
4. Problems resulting from failure to maintain pool water chemistry in accordance with recommended levels.
5. Problems resulting from tampering, accident, abuse, negligence, unauthorized repairs or alterations, fire, flood, lightning, freezing, external water, war, or acts of God.

THE EXPRESS LIMITED WARRANTY ABOVE CONSTITUTES THE ENTIRE WARRANTY OF GOLDLINE CONTROLS, INC. WITH RESPECT TO ITS POOL AUTOMATION AND CHLORINATION PRODUCTS AND IS IN LIEU OF ALL OTHER WARRANTIES, EXPRESSED OR IMPLIED, INCLUDING WARRANTIES OF MERCHANTABILITY OR FITNESS FOR A PARTICULAR PURPOSE. IN NO EVENT SHALL GOLDLINE CONTROLS, INC. BE RESPONSIBLE FOR ANY CONSEQUENTIAL, SPECIAL OR INCIDENTAL DAMAGES OF ANY NATURE WHATSOEVER.

NO WHOLESALE, AGENT, DEALER, CONTRACTOR, OR OTHER PERSON IS AUTHORIZED TO GIVE ANY WARRANTY ON BEHALF OF GOLDLINE CONTROLS, INC. THIS WARRANTY IS VOID IF THE PRODUCT HAS BEEN ALTERED IN ANY WAY AFTER LEAVING THE FACTORY.

Aqua Logic Programming Flow Chart

