

Compool® to EasyTouch® Pool and Spa Control System Upgrade



Installation and User's Guide

IMPORTANT SAFETY INSTRUCTIONS
READ AND FOLLOW ALL INSTRUCTIONS
SAVE THESE INSTRUCTIONS

IMPORTANT INFORMATION

How to change your Compool/EasyTouch Upgrade system to a “Single Body” system

Configuring Compool/EasyTouch as a SINGLE BODY SYSTEM

The Compool EasyTouch Upgrade circuit board is factory configured and ready to operate as a **SHARED EQUIPMENT** system (Jumper J25 = ON). To change the Compool EasyTouch Upgrade board to operate a **SINGLE BODY** system, first remove Jumper 25 (place the jumper on one of the pins) and erase the EEPROM (see page 49).

To change Compool EasyTouch circuit board:

Getting There

MENU ▼ SETTINGS ▼ Erase EEPROM ► Erase EEPROM

1. Write down your Compool system settings and connections (e.g. filter pump schedules, auxiliary connection for lights, spa jets etc.).
2. **Change system to SINGLE BODY system (jumper OFF):** Remove circuit board **Jumper J25**. Place the jumper on one of the pins. J25 is located in the upper/center of the circuit board (see page 76).
3. **Erase the circuit board EEPROM:** Power up the Compool EasyTouch Upgrade circuit board. To erase the EEPROM, press **MENU > SETTINGS > Erase EEPROM** and follow the screen prompts as shown below:

Erase EEPROM ▲
Erase ALL? No (Yes) ▼

Up/Down button: Select **Yes**.

Erase EEPROM ▲
Are You Sure?
No (Yes) ▼

Right button: The message “**Erase EEPROM Are You Sure? No**” is displayed.

Up/Down button: Select **Yes**.

AUTO HEATER
SPA 95°F / 100°F
AIR 70°F
MON 09:30 AM

Right button: Press this button to erase system data and restore the factory defaults. The display will go blank, then the main screen will be displayed.

4. **Continue to setup your system using the EasyTouch menu (see page 14).**

© 2010 Pentair Water Pool and Spa, Inc. All rights reserved.

1620 Hawkins Ave., Sanford, NC 27330 • (919) 566-8000

10951 West Los Angeles Ave., Moorpark, CA 93021 • (800) 553-5000

EasyTouch®, Compool®, IntelliChlor®, IntelliFlo®, MagicStream®, ThermalFlo®, QuickTouch®, IntelliBrite®, SAm®, SAL®, FIBERworks®, Photon Generator®, and Pentair Water Pool and Spa® are trademarks and/or registered trademarks of Pentair Water Pool and Spa, Inc. and/or its affiliated companies in the United States and/or other countries. Unless noted, names and brands of others that may be used in this document are not used to indicate an affiliation or endorsement between the proprietors of these names and brands and Pentair Water Pool and Spa, Inc. Those names and brands may be the trademarks or registered trademarks of those parties or others.

Contents

IMPORTANT SAFETY PRECAUTIONS	iii
EasyTouch System Kit Contents	v
Accessory Equipment	v
Technical Support	v
How to Change the system to a SINGEL BODY system	v
Section 1 - Compool to EasyTouch Pool and Spa Control System Upgrade Overview	1
Compool® EasyTouch® Pool and Spa Control System Upgrade Overview	1
Compool upgrade systems	1
Operating EasyTouch	1
IntelliChlor® Electronic Chlorine Generator	1
Compool EasyTouch Upgrade System Overview	2
Compool EasyTouch Upgrade Control Panel	3
Comppol/EasyTouch Upgrade Controls and Buttons	3
iS4 Spa-Side Remote Controller (Optional)	6
QuickTouch® QT4 Wireless Controller (Optional)	6
iS10 Spa-Side Remote Controller (Optional)	6
EasyTouch Indoor and Wireless Control Panel (Optional)	7
Compool/EasyTouch Upgrade Outdoor Control Panel Operating Modes	8
Quick Start - Spa and Pool Operations (Shared Equipment)	9
Heat your spa or pool	9
Adjust your spa or pool heat settings	9
Switch on lights manually and synchronize light colors	10
Using the Once Only timer feature	10
Schedule start and stop times for equipment	11
Program your Spa or Pool	11
Schedules	11
Setting the Egg Timer Feature	12
Section 2 - Setting up the Compool/EasyTouch Upgrade System	13
EasyTouch Menus	14
Main Screen	16
Feature Circuits Menu	17
Lights Menu	18
The Color Swim and Color Set Lighting Features	18
Setting up Lights	19
Assign the Light Circuit Name and Function	19
Setting up IntelliBrite Light Circuits	20
Lights Menu	20
Modes (IntelliBrite Color light shows, Color Swim, Color Set)	20
Modes (Color Swim)	20
Modes (Color Set)	21
Colors	21
Hold/Recall	21
All On / All Off (Lights Menu)	21
Sync	21
Setting up SAM, SAL, PG2000, Color Wheel Lights	22
Config	22
Setting up MagicStream Laminars	23
Using the MagicStream Laminar Features	24
Heat Menu	25
Pool Temp/Src	25
Spa Temp/Src	25
Delay Cancel Menu	26

Contents (Continued)

Schedules Menu	27
Using the Schedules menu	27
Schedule your spa/pool pump to turn on	28
Using the Once Only feature	29
Using the Egg Timer (countdown) Feature	30
Settings Menu: Clock	31
Settings Menu: IntelliFlo® VS and VF	32
IntelliFlo® VS pump	32
IntelliFlo® VS pump	33
Settings Menu: IntelliChlor	35
Settings Menu: ThermalFlo® Heat Pump	36
Settings Menu: Circuit Names	37
Hi-Temp/Lo-Temp Controls for Single Body System	37
EasyTouch Circuit Names	38
Settings Menu: Circuit Functions	39
Freeze Protection	39
Preset Circuit Functions	40
Settings Menu: Custom Names	41
Settings Menu: Valves	41
Settings Menu: 2-Speed Pump	42
Settings Menu: Solar	42
Settings Menu: Delays	43
Settings Menu: F° / C° (Fahrenheit/Celsius)	44
Settings Menu: iS4 Spa-Side Remote Controller	44
Settings Menu: iS10 Spa-Side Remote Controller	45
Settings Menu: iSx Pump Cntrl	46
Assign iSx Pump Cntrl	46
Settings Menu: QuickTouch (QT4) Wireless Remote	47
Settings Menu: Man Heat (Off/On)	48
Settings Menu: Calibration	48
Settings Menu: Erase EEPROM (Erase System Memory)	49
Settings Menu: Set Password	49
Settings Menu: Wireless Addr	50
Spa Side [Off/On]	51
Diagnostics Menu: Software Rev	51
Diagnostics Menu: Bootloader Rev	51
Diagnostics Menu: Self Test	52
Diagnostics Menu: Chlorinator	53
Diagnostics Menu: Water Temp	53
Diagnostics Menu: Solar Temp	53
Diagnostics Menu: Air Temp	54
Diagnostics Menu: Cir Name: [Off/On]	54
Diagnostics Menu: Reset System	54
Diagnostics Menu: Flash Update	54
Section 3 - Troubleshooting	55
Troubleshooting	55
Frequently Asked Questions (FAQ)	55
EasyTouch Error Messages	56
Self Test Error Codes	56
Error Code Table	56
Maximum Programs Exceeded	57
IntelliChlor Error Messages	57
System Problem Diagnosis	58

Contents (Continued)

First Time System Start-Up	61
System Test	61
Testing the Auxiliary Relays	61
Setting up the EasyTouch wireless control panel for the first time	62
Setting up the EasyTouch wireless control panel	62
Synchronizing control panels	63
Wiring ThermalFlo to EasyTouch	63
Wiring Description	63
Section 4 - Compool/EasyTouch Upgrade Kit Installation	65
Compool/EasyTouch Upgrade Kits	65
Compool/EasyTouch Upgrade Models	
Compool/EasyTouch Upgrade Models (Single Body Systems)	66
Compool/EasyTouch Upgrade Models (Shared Equipment Systems)	67
Installing Compool/EasyTouch Upgrade Control Panel (with or without Transformer Kit)	68
Compool Power Center (without sub-panel)	68
Compool Load Center (with breaker sub-panel)	72
Installing the Compool/EasyTouch Upgrade Control Panel (Compool Load Center with sub-panel)	74
Compool/EasyTouch Upgrade Circuit board Wiring Diagram	76
Compool 3810 Circuit board Wiring Diagram	77

IMPORTANT WARNINGS AND SAFETY PRECAUTIONS

⚠ DANGER SERIOUS BODILY INJURY OR DEATH CAN RESULT IF THIS PRODUCT IS NOT INSTALLED AND USED CORRECTLY.

⚠ DANGER INSTALLERS, POOL OPERATORS AND POOL OWNERS MUST READ THESE WARNINGS AND ALL INSTRUCTIONS BEFORE USING THIS PRODUCT.

⚠ WARNING This control system is intended for use in swimming pool applications.

⚠ WARNING Most states and local codes regulate the construction, installation, and operation of public pools and spas, and the construction of residential pools and spas. It is important to comply with these codes, many of which directly regulate the installation and use of this product. Consult your local building and health codes for more information.



IMPORTANT NOTICE - Attention Installer: This Installation and User's Guide ("Guide") contains important information about the installation, operation and safe use of this product. This Guide should be given to the owner and/or operator of this equipment.

⚠ WARNING Before installing this product, read and follow all warning notices and instructions in this Guide. Failure to follow warnings and instructions can result in severe injury, death, or property damage. Call (800) 831-7133 for additional free copies of these instructions. Please refer to www.pentair.com for more information related to this product.

⚠ DANGER Water temperature in excess of 100° F (37.7° C) may be hazardous to your health. Prolonged immersion in hot water may induce hyperthermia. Hyperthermia occurs when the internal temperature of the body reaches a level several degrees above normal body temperature of 98.6° F (37° C.). Effects of hyperthermia include: (1) Unawareness of impending danger. (2) Failure to perceive heat. (3) Failure to recognize the need to leave the spa. (4) Physical inability to exit the spa. (5) Fetal damage in pregnant women. (6) Unconsciousness resulting in danger of drowning. The use of alcohol, drugs, or medication can greatly increase the risk of fatal hyperthermia in hot tubs and spas. To reduce the risk of injury, do not permit children to use or operate this sand filter.



⚠ WARNING When setting up pool water turnovers or flow rates the operator must consider local codes governing turnover as well as disinfectant feed ratios.

⚠ WARNING DO NOT increase pump size; this will increase the flow rate through the system and may exceed the maximum flow rate stated on the drain cover.

⚠ WARNING Water temperature in excess of 100 degrees Fahrenheit may be hazardous to your health. Prolonged immersion in hot water may induce hyperthermia. Hyperthermia occurs when the internal temperature of the body reaches a level several degrees above normal body temperature of 98.6° F (37° C). The symptoms of hyperthermia include drowsiness, lethargy, dizziness, fainting, and an increase in the internal temperature of the body. The effects of hyperthermia include: 1) Unawareness of impending danger. 2) Failure to perceive heat. 3) Failure to recognize the need to leave the spa. 4) Physical inability to exit the spa. 5) Fetal damage in pregnant women. 6) Unconsciousness resulting in danger of drowning.

⚠ WARNING To reduce the risk of injury, do not permit children to use this product unless they are closely supervised at all times.

⚠ WARNING The use of alcohol, drugs, or medication can greatly increase the risk of fatal hyperthermia in hot tubs and spas.

⚠ WARNING Control System is intended to control heaters with built-in high limit circuits **ONLY**. Failure to do so may cause property damage or personal injury.

⚠ WARNING Do not use this product to control an automatic pool cover. Swimmers may become entrapped underneath the cover.

IMPORTANT WARNINGS AND SAFETY PRECAUTIONS

- ⚠ WARNING** For units intended for use in other than single-family dwellings, a clearly labeled emergency switch shall be provided as part of the installation. The switch shall be readily accessible to the occupants and shall be installed at least 10 feet (3.05 m) away, adjacent to, and within sight of, the unit.
- ⚠ WARNING** Except for listed spa-side remote controls, install a minimum of five (5) feet from the inside wall of the pool and spa.
- ⚠ WARNING** **TO PREVENT ELECTROCUTION: INSTALL THE POWER CENTER OR LOAD CENTER AT LEAST FIVE (5) FEET (1.2M) FROM INSIDE WALL OF POOL OR SPA.**

Two Speed Pump Controls Notice (Title 20 Compliance)

Please read the following important Safety Instructions (See page 42 for pump speed setup)

When using two-speed pumps manufactured on or after January 1, 2008, the pump's default circulation speed **MUST** be set to the **LOWEST SPEED**, with a high speed override capability being for a temporary period not to exceed one normal cycle, or two hours, whichever is less.

Important Installation Information

1. All work must be performed by a licensed electrician, and must conform to all national, state, and local codes. The electrical supply for this product must include a suitably rated switch or circuit breaker to open all ungrounded supply conductors to comply with National Electrical Code (NEC), NFPA 70 (including Artical 680) or the Canadian Electrical Code (CEC), CSA C22.1. The disconnecting means must be readily accessible to the tub occupant but installed at least 5 ft. (1.52 m) from the inside wall of the Pool, Spa, or Hot Tub.
2. Install to provide drainage of compartment for electrical components.
3. Install enclosure with conduit holes down.
4. If this system is used to control underwater lighting fixtures, a ground-fault circuit interrupter (GFCI) must be provided for these fixtures. Conductors on the load side of the ground-fault circuit-interrupter shall **not** occupy conduit, junction boxes or enclosures containing other conductors unless such conductors are also protected by a ground-fault circuit-interrupter. Refer to local codes for details.
5. A terminal bar stamped  is located inside the supply terminal box. To reduce the risk of electric shock, this terminal must be connected to the grounding means provided in the electric supply service panel with a continuous copper wire equivalent in size to the circuit conductors supplying this equipment (no smaller than 12 AWG or 3.3 mm). The bonding lug(s) provided on this unit are intended to connect a minimum of one No. 8 AWG for US installation and two No. 6 AWG for Canadian installations solid copper conductor between this unit and any metal equipment, metal enclosures or electrical equipment, metal water pipe, or conduit within 5 feet (1.5 m) of the unit.
6. Use 14 AWG to 6 AWG, 60° / 75° C Copper conductors for all field wiring.
7. Electrical rating: 120/240 VAC 150 AMP Single Phase (3 wire).
8. The input line to the control panel should be protected by a 240 VAC CIRCUIT BREAKER rated at NO MORE then 150 Amperes maximum.

Compool to EasyTouch Upgrade System Kit Contents

The following items are included in the Compool to EasyTouch Upgrade System kit.

- Compool To EasyTouch Upgrade Kit (P/N 521107) - For upgrading CP3xxx systems
 - Compool To EasyTouch Upgrade Kit with Transformer (P/N 521247) - For upgrading Cp100, Cp1000, Cp2000 system.
 - Temperature sensor with 20 foot cable, o-ring and hose clamp (P/N 520272) - Uses for the water temperature sensor
 - Temperature sensor with 40 inch cable - Used for the air temperature sensor
 - Compool to EasyTouch Upgrade Pool and Spa Control System Installation and User's Guide (this manual)
- Optional Equipment
- IntelliChlor Electronic Chlorine Generator Electrolytic Cell - IC20 (P/N 520554), IC40 (P/N 520555) or IC60 (P/N 521105)

Accessory Equipment

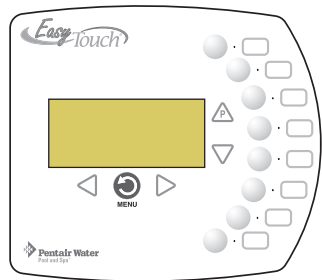

EasyTouch 8 Indoor Control Panel Kit (P/N 520549)



EasyTouch Wireless Control Panel (8 circuit) Kit (P/N 520547)



iS10 Spa-Side Remote Controller (P/N 520149)



iS4 Spa-Side Remote Controller (P/N 520094)



QuickTouch® wireless remote controller Kit (P/N 520148)

EasyTouch Accessories (continued)

EasyTouch Indoor Control Panel, 8 Circuits	(P/N 520549)
EasyTouch Wireless Control Panel, 8 circuits	(P/N 520547)
iS4 Four-Function Spa-Side remote, 150 ft. cable	(P/N 520094)
iS10 Ten-Function Spa-Side remote, 150 ft. cable	(P/N 520149)
QuickTouch four-function wireless remote kit with transceiver assembly	(P/N 520148)
IntelliChlor Acid Cleaning Kit	(P/N 520670)
IntelliChlor Spacer pass-through cell for new pool start-up	(P/N 520588)

Technical Support

Sanford, North Carolina (8 A.M. to 5 P.M.)
 Phone: (800) 831-7133 - Fax: (919) 566-8920
Moorpark, California (8 A.M. to 5 P.M.)
 Phone: (800) 831-7133 - Fax: (805) 553-5515

visit www.pentairpool.com and www.staritepool.com

Section 1

Overview

Compool® EasyTouch® Pool and Spa Control System Upgrade Overview

Welcome to the Compool EasyTouch upgrade Pool and Spa Control system – The next generation in automatic control systems. Your Compool EasyTouch upgrade system opens up a wide range of automation features. Your EasyTouch eight auxiliary system allows you to automatically control all of your spa and pool daily operations. Pool and spa service operations can be manually controlled from the EasyTouch outdoor control panel located at the pool equipment pad. Also available is the optional Indoor Control Panel and Wireless Control Panel which allows automatic control of pool and spa operations from inside your home or outside around your pool area.

The EasyTouch eight auxiliary circuit system is factory configured to operate as a “shared” equipment system or it can be configured as a “single body” system (see page 64). For EasyTouch menu settings, see page 14. The EasyTouch eight auxiliary system can control high voltage (120 VAC / 240 VAC) equipment, automatic valve actuators, pumps, lighting, a conventional heater or a solar heating system and the optional IntelliChlor salt chlorine generator.

Compool upgrade systems

The following Compool systems can be upgraded to the Compool/EasyTouch system: Compool CP3xxx models (see page 66 and 67), also Compool TimeMaster, CP/LX100, CP1000, CP2000 and CP3000 models. **Note: To upgrade Compool TimeMaster, CP/LX100, CP1000, CP2000 models requires Compool/EasyTouch control panel upgrade kit with transformer P/N 521247). Otherwise CP3xxx systems require P/N 521107.** For Compool/EasyTouch Control Panel with or without Transformer Kit installation instructions, see page 65).

Operating EasyTouch

The EasyTouch system is designed to automatically control your pool and spa equipment, lights and other optional equipment. However, you can also manually control all EasyTouch system operations from the outdoor control panel. Using the “Mode” button, the system can be switched from “Auto” mode (normal operating mode) to “Service” mode for manual operation and service purposes. Using the outdoor control panel buttons you can manually override any automatic settings. If required, the EasyTouch outdoor control panel can be password protected. To access a password protected control panel, the correct four digit password must be entered before access is granted (see page 49).

IntelliChlor® Electronic Chlorine Generator

The optional IntelliChlor salt chlorination system allows the EasyTouch system to automatically control water sanitization by using a low concentration of salt (sodium chloride) in the pool and spa water. The IntelliChlor is enabled from the “IntelliChlor” Settings menu (see page 35). IntelliChlor automatically converts the salt into free chlorine which eliminates bacteria and algae in the pool and spa water. The chlorine will then revert back to sodium chloride after killing the bacteria. The outcome of this continuous cycle, practically eliminates the need to use sanitizing chemicals in the pool/spa water. When the pool and spa water is replenished due to backwashing or draining, more salt may need to be added to the pool/spa water. IntelliChlor model IC20 (P/N 520554/520556) is designed for swimming pools up to 20,000 U.S. gallons (75,000 liters). Model IC40 (P/N 520555/520556) is designed for swimming pools up to 40,000 U.S. gallons (151,000 liters). IC60 Cell (P/N 521105): Designed for pools up to 60,000 U.S. gallons (227,124 liters). The pool chlorination amounts may vary depending on number of pool occupants, temperature, environment conditions, rainfall and other elements that might affect the pool water.



IntelliChlor Electronic Chlorine Generator

Compool EasyTouch Upgrade System Overview

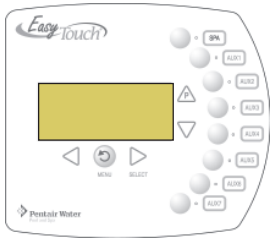

EasyTouch Indoor Control Panel (P/N 520549) (Optional)

Connects to Compool/EasyTouch Upgrade motherboard via RJ12 Adapter or 4-position screw terminal



EasyTouch Wireless Control Panel (8 circuit) (P/N 520547) (Optional)



Low Voltage (DC) circuit breakers



iS4 Spa-Side Remote (P/N 520094) (Optional)



QuickTouch® (QT4) wireless remote Controller (P/N 520148) (Optional)



iS10 Spa-Side Remote (P/N 520149) (Optional)

Temperature Sensors (Water, Air and Solar optional)
Electric Heater - Connects to plug J19 on motherboard

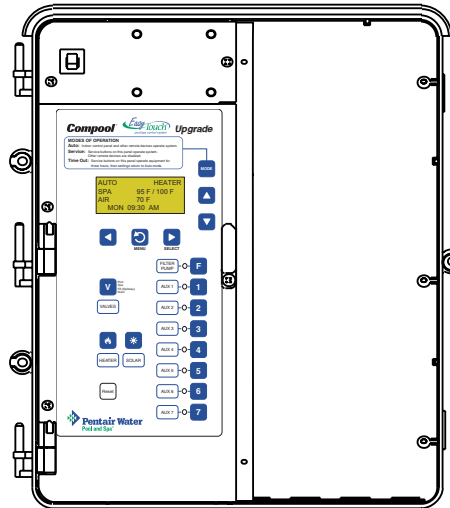

Compool Power Center (shown without subpanel)

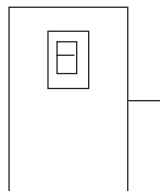

Main Power GFCI Panel 240 VAC 50 AMP (40 AMP recommended 8 AWG)

- **Pumps**
Filter, Cleaner, Spa Jet -
1.5 HP 120 VAC
3 HP 277 VAC
20 FLA/120 LRA, 120 VAC
17 FLA/102 LRA, 277 VAC
- **Pool/Spa Lights**
1.5 KW 120 VAC Tungsten
4.8 KW 240 VAC Tungsten
20 AMP, 277 VAC Ballast
- **Pool/Spa Valve**
Suction and return.
24 VAC valve actuator, shared equipment only
- **Auxiliary Valves**
(Qty. 2) A and B
- **Heater**
Gas or electric
- **Relays**
20 AMP, 2 HP, 240 VAC
30 AMP, 3 HP, 240 VAC optional

Optional equipment



- IntelliChlor Salt Chlorine Generator (SCG)
- IC20 P/N 520554/520556
- IC40 P/N 520555/520556
- CIC60 P/N 521105 (see page 26)

Compool EasyTouch Upgrade Control Panel

Your EasyTouch upgrade system can fully automate your pool, spa functions and any auxiliary circuits (additional pumps and lighting) from the EasyTouch upgrade outdoor control panel or from the optional EasyTouch indoor control panel and EasyTouch wireless control panel. The EasyTouch menu features let you create customized schedules for your pool and spa equipment, heat temperatures, and chlorination settings to switch on and off at a set day and time. Scheduled automatic operations can be performed at either the outdoor control panel, the optional indoor control panel and wireless control panel. For maintenance and service purposes, the outdoor control panel button allows manual control of all pool and spa operations. For menu options, refer to “EasyTouch Menus,” on page 14. The following describes the outdoor control panel buttons, and LED indicators.

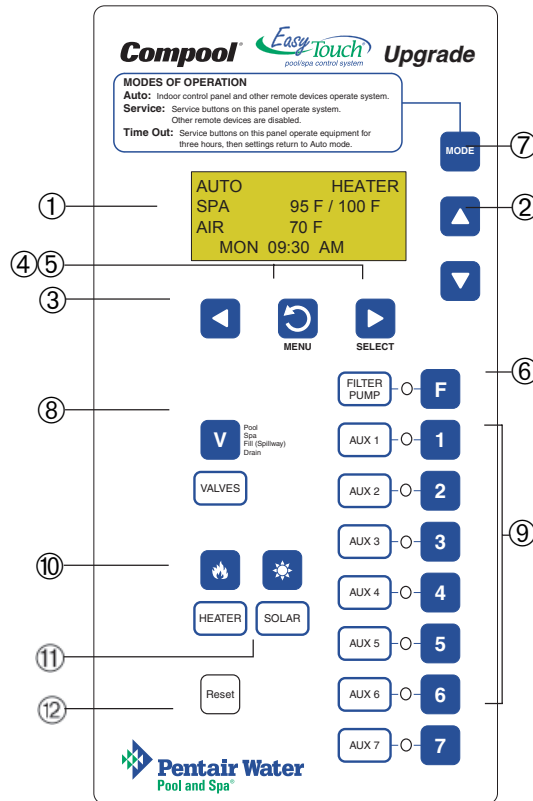



Compool/EasyTouch Upgrade Outdoor Control Panel

Comppol/EasyTouch Upgrade Controls and Buttons

- ① **Liquid Crystal Display (LCD):** The main system display consists of a 16 x 4 alphanumeric character LCD with LED backlighting for easy viewing of the menu items and status messages. If necessary, press the Menu button twice to refresh the display.
- ② **Up/Down buttons:** Use the Up and Down buttons to scroll through the main menu items and to adjust or change settings. Use these buttons after pressing the Menu button to access the main menu items. While editing settings, press and hold the Up or Down button to fast forward or fast reverse through settings and values.
- ③ **Left button:** When in pool or spa mode use the Left and Right button to adjust the temperature level. Press the Left button to lower the set point water temperature. Press the Filter Pump (F) button to display the current water temperature. Use the Left button to scroll through sub-menu selections, setting and values. While editing settings, press and hold the Left button to fast reverse through settings and values.

Controls and buttons (Continued)

- ④  **Menu/back button:** Use this button to access, save and exit from a current menu or sub-menu settings. Also, while in a menu or sub-menu items, use this button to go back to a previous menu level or item. If no menu activity is detected after five minutes, the main screen is displayed. All menu settings are permanently saved and retained in the control panel even after power is removed from the control panel. Control panel buttons are disabled while in the menu mode.
- ⑤  **Right button/SELECT:** When in pool or spa mode use the Left and Right button to adjust the temperature level. Press the Right button to raise the set point water temperature. Press the Filter Pump (F) button to display the current water temperature. Use the Right button to select a sub-menu item for editing. After pressing the Menu button to access the main menu items, use the Right button to select the menu item and access the sub-menu items for adjustment. While editing a settings, press and hold the Right button to fast forward through settings and values.
- ⑥  **Filter Pump (F) button/LED:** Switches a single speed filter pump on and off in “Pool” or “Spa” mode. Press the Valves (V) button to toggle between “Pool” and “Spa” mode and rotate valves. If “Heater” is enabled in the “Heat” menu (see page 25), pressing the Filter Pump button will also enable the selected heat source (Heater/Solar LED on). The default time before the filter pump will switch off is 12 hours. This button operates in “Auto” or “Service” mode.

Single-Speed Filter Pump: If the pump is currently off, press the Filter Pump button (LED on) to switch the pump on. Press the Filter Pump button again to switch the pump off. However, if the heater is operating, and a delay is enabled for valves, this allows the heater to cool down (heater cool-down), then when you press the F button to switch off the pump, only the heater will turn off, then the filter pump will automatically switch off after 10 minutes to allow the heater to cool down. Pentair Water Pool and Spa® heaters do not require a cool down time. To override the “heater cool-down,” press the Filter Pump button again to switch off the pump.

Two-Speed Filter Pump: Press the Filter Pump button (LED on) to switch the two-speed pump on in high speed. If you switch the pump off to low speed shortly after switching it to high speed, the filter pump will automatically remain in high speed for a few minutes before switching back to low speed to allow the pump to prime and establish normal water flow. In order to use the “2-Speed Pump” menu assignments (see page 42), the 2-Speed relay option must be installed in the EasyTouch Load Center.

Freeze Protection: This function protects the pool, plumbing, and equipment against freeze damage. If the outside air temperature sensor falls below 36° F, “Freeze Protection” is activated and the Filter Pump relay is switched on to circulate the pool water. To enable freeze protection for a circuit, see “Settings Menu: Circuit Function,” on page 39.





- ⑦  **Mode button:** Use this button for service purposes to manually control the EasyTouch system. Press this button once activate “Service” mode, to allow AUX circuit buttons, Filter Pump, Valves, Heater and Solar buttons to be operated manually. Press the button a second time to enable “Timeout” mode. This mode is similar to “Service” mode except that the system will automatically return to normal operation (Auto) after three hours. Press the button a third time to return the system to “AUTO” mode. The current operating status is shown in the LCD display. The menu buttons, remote controllers, and menu scheduled operations are disabled (except for switching off equipment manually for emergencies) while the system is in “Service” mode.

Auto: In Auto (automatic) mode the system is in normal operating mode and is controlled by the main control panel LCD menu features.

Service: Use this mode to service pool equipment and to operate equipment manually.

Timeout: Same functionality as “Service” mode, except that the system will automatically return to normal operation (Auto) after three hours.

Controls and buttons (Continued)

- ⑧  **Valves (V) - (Pool/Spa/Fill (Spillway)/Drain) button:** When in normal operating mode, the Valves (V) button is in “Pool” mode. In this mode the valves are automatically rotated so that only the pool water is circulated through the system and the filter pump is activated. Pressing this button once enables “Spa” mode and activates the filter pump to circulate only spa water through the system. “Fill/Spillway” and “Drain” mode can only be used while in “Service” mode (See Mode button for details). “Fill/Spillway” and “Drain” mode are used when cleaning the spa. Pressing the Valves (V) button again returns the system to “Pool” mode. Note that the filter pump will switch off while the pool/spa valves are rotating into position. The current operating mode is shown in the LCD display. *Note: The Valves button (Pool, Spa, Fill (Spillway), Drain) button has no function in “Pool only” or “Spa only” systems. For an EasyTouch single body system, “Pool” and “Spa” modes are Lo- Temp (Pool) and Hi-Temp (Spa) temperature controls. For more information, see “Hi-Temp/Lo-Temp Controls for Single Body Systems,” page 37.*
- ⑨  **Aux 1 - 7 buttons/LEDs:** Auxiliary output circuit buttons operate the pool and spa system valves, lights and other equipment. These auxiliary circuits are assigned in the “Circuit Function” menu, see page 39 for details. There are seven auxiliary circuits (AUX 1- 7) on Compool/EasyTouch outdoor control panel. The Solar button can also be used for an “extra” auxiliary circuit if the Solar circuit is not being for solar equipment. Labels can be affixed next to each auxiliary button to identify the circuit function. Labels can be affixed over each auxiliary button to identify the circuit function. When an auxiliary circuit is activated or the button is pressed, the LED is on. Pressing an auxiliary circuit button will activate the corresponding circuit in either “Auto” or “Service” mode. When a circuit relay is switched on manually, it remains on until either you switch it off manually, or the next time the relay is scheduled to be switched off. For example, if the filter pump is scheduled to automatically run from 9:00 AM to 5:00 PM daily then the filter pump is switched on manually at 9:00 PM, it will run continuously until the next day at 6:00 PM then switch off. The schedule will then continue from then on.
- ⑩  **Heater (Flame) button/LED:** This button is only used in “Service” mode for manual heat on and off control. The Heater LED will be on if “Heater” is enabled in the “Heat” menu setting (see page 25). Switching the heater on automatically controls the output between a “forced off” state and a normal automatic thermostatic control operating state. The heater will continue heating the water until the heater’s current highest set point temperature triggers the heater sensor (approximately 104° F). Note that the Heater button does not activate the pump. Do not activate the heater without running the pump. The heater will not run if water flow is not detected.
- ⑪  **Solar (Sun) button/LED and (Aux Extra):** In solar mode this button is only used in “Service” mode for manual solar heat on and off control. The Solar LED will be on if “Solar” is enabled in the “Heat” menu setting. Solar must also be enabled in the “Solar” menu. Use the Solar button to manually switch the heater control output between a “forced off” state and a normal automatic thermostatic control operating state. When this button is pressed the solar relay is switched on to activate a booster pump if installed and activates valves to rotate to divert water through solar heating panels. If solar equipment is not being used, this button can also be used to switch the AUX EXTRA circuit on and off.
- ⑫  **Reset button:** Press this button to reinitialize the Compool/EasyTouch outdoor control panel.

iS4 Spa-Side Remote Controller (Optional)

The iS4 Spa-Side remote controller is a double-insulated, waterproof device that is UL (1563) listed for installation at the water's edge. Pentair recommends that the iS4 always be installed above the water line of the spa wall, or in the deck within arm's reach of a spa occupant. The iS4 provides remote switching of up to four control circuits from the spa location. It is typically used for activating spa circulation and any three auxiliary pieces of equipment (such as lights, jet pump, air blower, etc.). The red status LED indicator glows steady when in Spa mode and flashes while the spa is heating. For more about assigning circuits to the iS4 buttons, refer to "Settings Menu: iS4 Spa-Side Remote controller," on page 44. The iS4 two installation choices are shown below:

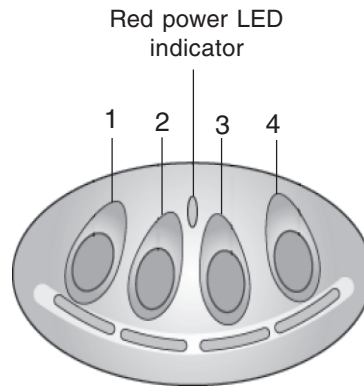

iS4 Spa-Side Remote Controller (Wall or tile mount)

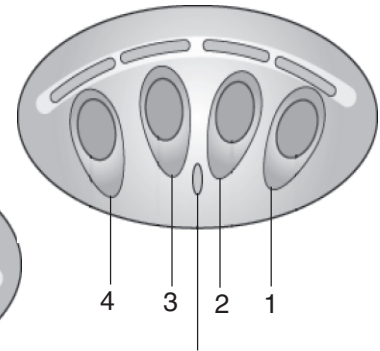

Red power LED indicator

iS4 Spa-Side Remote Controller (Deck mount)

QuickTouch® QT4 Wireless Controller (Optional)

The QuickTouch QT4 wireless remote controller provides switching of up to four circuits. You can use the QT4 wireless controller to activate the spa circulation, and for operating three auxiliary pieces of equipment (such as lights, jet pump, air blower, waterfall, etc.). Each of the four functions on the QT4 wireless controller has an on and an off button. For more about assigning circuits to the QT4 buttons, refer to "Settings Menu: QuickTouch (QT4) Wireless Remote," on page 47.

IMPORTANT: The QT4 wireless controller may be used with wet hands, but should never be submersed in water as this could damage the QT4. If accidental submersion occurs, dry the QT4 out by removing battery cover and removing battery. Position the QT4 so that water can drain out. Reassemble when the QT4 is completely dry.



QuickTouch (QT4) Wireless Remote Controller (P/N 520148)

iS10 Spa-Side Remote Controller (Optional)

An iS10 Spa-Side remote controller can control up to ten functions including a spa temperature adjustment. The iS10 Spa-Side remote controller is listed UL (1563) for use with the EasyTouch systems at the water's edge. Five (5) in-line buttons control up to ten (10) system functions numbered one through five from left to right. The middle peanut-shaped button toggles between the top and bottom row of buttons. The iS10 includes an LED display shows the current spa water temperature. The spa temperature may be increased or decreased by pressing the up or down arrow button located under the display. The temperature display will blink while being changed. After setting the desired temperature, the display will return to steady and show the actual temperature as it meets the set point. The temperature set by the iS10 is only temporary. When the Spa mode is switched OFF, the temperature set at the EasyTouch control panel will resume the next time the spa mode is activated (see "Man Heat" on page 48). The Spa Mode will automatically turn off after 24 hours. For iS10 setup and configuration information, see page 45.



iS10 Spa Side Remote Controller (P/N 520149)

EasyTouch Indoor and Wireless Control Panel (Optional)

The EasyTouch Wireless or the Indoor Control Panel allows you to control your pool and spa daily operations from around your pool area or inside your home. Use the “P” (Pool) and “Spa” (Pool) buttons to heat and filter your pool and spa. The Indoor Control Panel connects to the EasyTouch motherboard in the load center. For more information refer to the EasyTouch Indoor Control Panel User’s Guide (P/N 520616) and the EasyTouch Wireless Control Panel User’s Guide (P/N 520688).

Pool (Lo-Temp) Button: Switches the filter pump on, rotates valve actuator (to isolate pool water from spa water), and switches heater on. Lo-Temp (EasyTouch single body system) sets the low temperature settings for the pool (see page 37)

For details about the control panel LCD status messages, see page 8

Spa (Hi-Temp) Button: Switches the filter pump on, rotates valve actuator (to isolate spa water from pool water), and switches the heater on. Hi-Temp (EasyTouch single body system) sets the high temperature settings for the spa.

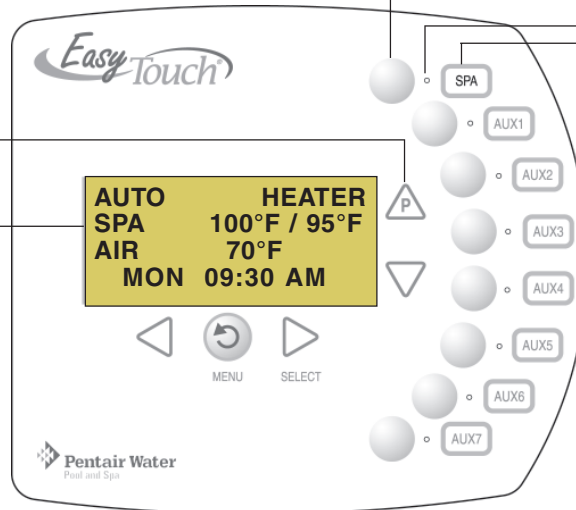

Circuit LED
Circuit name label

Seven user defined auxiliary circuits. Buttons switch the assigned circuit function on/off (12 hour time-out). Down arrow button can also be used for an “extra” auxiliary circuit if solar equipment is not being used

EasyTouch indoor control panel - (P/N 520549)

Pool (Lo-Temp) Button: Switches the filter pump on, rotates valve actuator (to isolate pool water from spa water), and switches heater on. Lo-Temp (EasyTouch single body system) sets the low temperature settings for the pool.

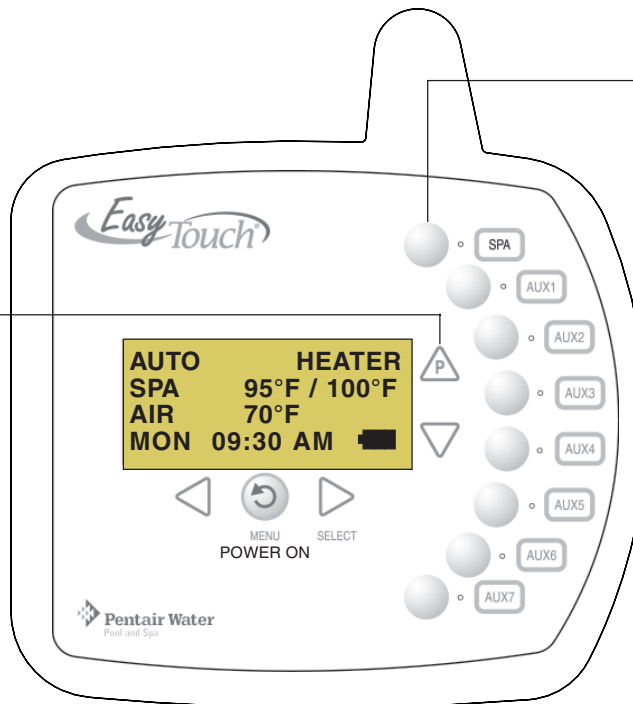

Spa (Hi-Temp) Button: Switches the filter pump on, rotates valve actuator (to isolate spa water from pool water), and switches the heater on. Hi-Temp (EasyTouch single body system) sets the high temperature settings for the spa.

Seven user defined auxiliary circuits. Buttons switch the assigned circuit function on/off (12 hour time-out). Down arrow button can also be used for an “extra” auxiliary circuit if solar equipment is not being used

EasyTouch wireless control panel - (P/N 520547)

Compool/EasyTouch Upgrade Outdoor Control Panel Operating Modes

The Compool/EasyTouch system can run in automatic mode or manual mode. Use the “Mode” button to switch the system from “Auto” mode (normal operating mode) to “Service” for manual operation and service purposes. Before operating EasyTouch, familiarize yourself with the LCD status messages and operating buttons.

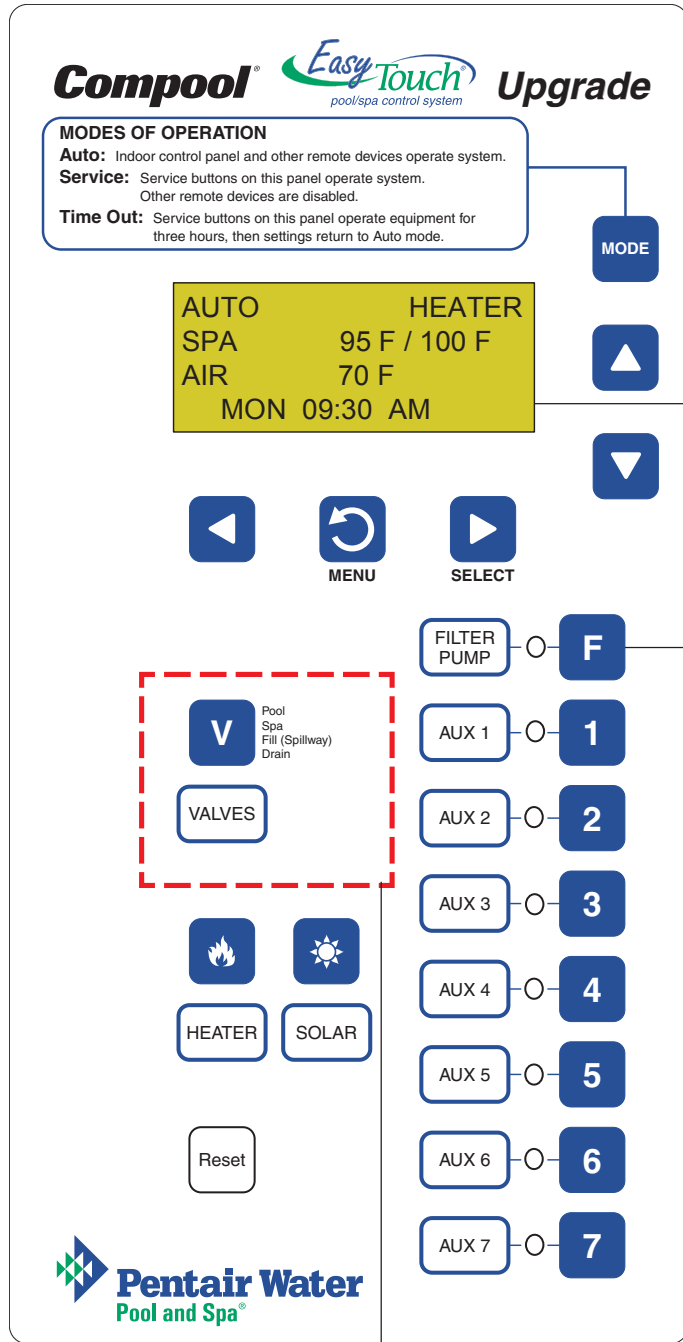

AUTO (Automatic): The system is in normal operating mode. Scheduled programs will run automatically.

HEATER: Displays the heat source (**Off, Heater, Solar Prf., Solar**) as specified in the Heater menu settings (see page 25). When the Filter Pump (F) button is pressed in “Pool” or “Spa” mode, and heat source is enabled (Heater button LED on).

POOL (SPA): Indicates that the Valves (V) button is in “Pool” or “Spa” mode and the Filter Pump (F) button has been pressed to switch on the filter pump. If this display line is blank, it indicates no spa or pool function is active. For an EasyTouch single body system, Hi-Temp (Spa) / Lo-Temp (Pool) sets the temperature settings (see page 37)

95° F / 100° F: Displays the actual spa or pool water temperature (95° F) and the set point temperature (100° F) as set in the “Heater” menu.

AIR: Displays the actual outside air temperature (70° F) as read by the air sensor located near the EasyTouch Load Center.

Date and Time: Displays the EasyTouch system day and time as specified in the “Clock” menu settings (see page 31).

Filter Pump button:

For spa operations, press the **Valves (V)** button to rotate valves into “Spa” mode, then press the **Filter (F)** button to activate the filter pump. Press the Valves button to toggle to “Pool” mode. The Heater button LED will be on if a heat source is enabled in the Heat menu.

Valves (V) button: When in normal operating mode, the system is in “Pool” mode so that only the pool water is circulated through the system. Press the Valves button to enable “Spa” mode and to rotate valves and activate the Filter pump (Filter Pump LED on) automatically so that only the spa water is circulated through the system. Note that the filter pump will switch off while the pool/spa valves are rotating into position. “Fill/Spillway” and “Drain” modes are used only in “Service” mode.

Quick Start - Spa and Pool Operations (Shared Equipment)

The following describes how to adjust heat temperature for the spa and pool water, schedule a daily run time for the pool/spa filter pump and control lights for shared equipment.

Heat your spa or pool

AUTO	HEATER
SPA	95°F / 100°F
AIR	70°F
MON	09:30 AM

First enable the heat source (see “Adjust your spa heat settings” below) then press the **Valves (V)** button to enable “Spa” mode, and press the **Filter Pump** button to activate the filter pump. When in normal operating mode, the Valves (V) button is in “Pool” mode which turns valves and activates the filter pump automatically so that only the pool water is circulated through the system. Press the button to enable “Spa” mode and activate the Filter pump to circulate only spa water through the system. In the main screen shown on left, 95°F is the current temperature and 100° F is set point temperature. By default, the setting “**Man Heat**” is set to “**On**” (see page 48) which allows the spa to begin to heat whenever it is manually switched on.

From the Indoor or wireless control panel (option): First enable the heat source in the Heat menu (see “Heat Menu,” on page 25). Press the **Spa** button (top button) to switch the filter pump on, rotate the valve actuator (to isolate spa water from pool water), and switch the heater on. Press the **Pool** button to switch the filter pump on, rotate the valve actuator (to isolate pool water from spa water), and switch the heater on. For Pool and Spa button location, see page 7.

Adjust your spa or pool heat settings

From the “Heat” menu (**MENU > HEAT > POOL TEMP/SRC OR SPA TEMP/SCR**) you can select the heat source and set the water temperature. The spa or pool water will heat to the settings specified. The EasyTouch system allows for solar and conventional heaters. The EasyTouch will use the heating source that is selected. The heat source selections are:

- **OFF** - No heating even though pump and other circuits may be operating.
- **HEATER** - Gas heater only.
- **SOLAR** - Solar heating system to be the only heat source. In order to display “Solar Only” as a heat option in the “Heat” menu, you must first enable solar in the **Settings > Solar** menu, (see page 42).
- **SOLAR PREF. (Solar Preferred)** - Used if solar and gas heating are combined and you want to use solar heating only when it is most effective. In order to display “Solar Preferred” as a heat option in the “Heat” menu, you must first enable solar in the **Settings > Solar** menu (see page 42).
- **Heat Pump (ThermalFlo):** If a heat pump is being used (ThermalFlo), enable the ThermalFlo and heating setting from the Settings > ThermalFlo > Settings menu options (see page 36).

To set the spa temperature set point and select the heat source:

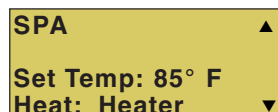
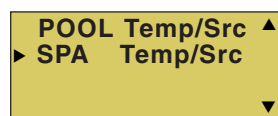

Right button: Select spa temperature and heat source.

Up/Down button: Adjust the spa water temperature.
(from 40° F to 104° F or 4° C to 40° C)

Right or Left button: Select Heat source options.

Up/Down: Set the Heat option: **Off, Heater, Solar, or Solar Preferred.**

Press the **Menu** button to save the settings and to return to the Heat menu or press the button again to return to the main screen. **Note:** Select “**POOL Temp/Src**” to adjust the pool temperature.

Switch on lights manually and synchronize light colors

From the Lights screen you can manually switch all lights on or off, and synchronize colored lights. Up to 12 lights can be controlled. For more information about setting up lights, including IntelliBrite® LED lights and MagicStream® laminars, refer to “Lights Menu” on page 20.



To manually switch on all lights and synchronize light colors:

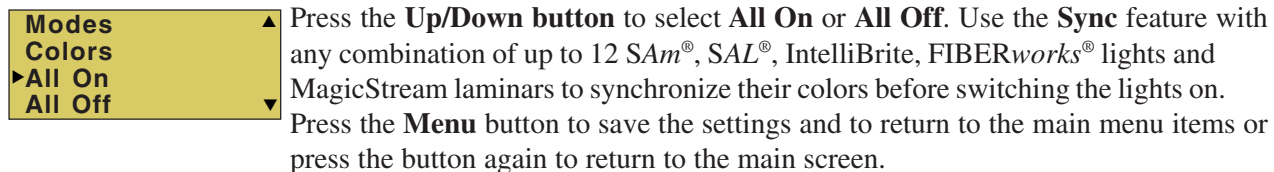

Using the Once Only timer feature

The Schedules “Once Only” timer feature lets you to automatically switch equipment on for one time. This feature allows you to program a circuit to turn on at a particular time on a onetime basis. For example, if you wanted the spa to be heated when you arrive home, you could program the heater to switch on at a specific time and after you have finished using the spa you can switch the heater off manually. After the program has run, it is automatically erased. Unlike using the regular “Schedule” program, the “Once Only” program does not repeat. The circuit must be turned off manually or wait for the 12 hour automatic shut-off. However, you could also reset the 12 hour factory shut-off by entering an “Egg Timer” count down program to extend past the default 12 hours shut-off.

To schedule a specific time to turn on the spa or pool heat using the “Once Only “ feature:

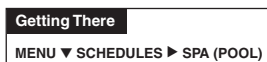

Right button: Select the **Spa** circuit.

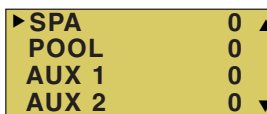

Right button: Select **Mode** if there are existing programs. Skip this step to create a new program.

Up/Down button: Select **New** to create a new program.

Right button: To create a new program and enter the “Mode” settings.

Up/Down button: 1/1 indicates that this circuit has one program. If there are existing programs assigned to this circuit, use these buttons to view and select the existing program settings.

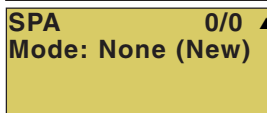

Right button: To select the “Once Only” settings.

Right button: Select start time setting.

Up/Down and Right buttons: Set the start hour (A/P) and minutes. A (AM) and P (PM) time is set when setting the start hour.

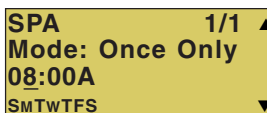

Right button: Select the day of the week to run the program.

Right button: Select which day to run the program then press the **Up/Down button** to enable the bar on top of the letter. A bar on top of the letter indicates the day selected to run the program.

Press the **Menu** button to save the settings and to return to the Schedules menu options. Press the Menu button again to return to the main menu options or press again to return to the main screen.

Schedule start and stop times for equipment

You can set timers (schedules) to automatically run equipment for pool filtration or turn on or off lights. Any EasyTouch circuit can be set to switch on and off on every or any day of the week. Up to 12 total system programs may be created for all circuits combined.

Program your Spa or Pool

You can use the “Schedule” feature to set the time and day(s) when to switch the filter pump on and rotate the pool/spa valves into the “Pool” or “Spa” position. The heater will automatically heat the pool or spa water up to the set point temperature as set in the “Heat” menu (see page 25). If the pool has a separate jet pump or blower controlled by AUX 1 and/or AUX 2, these need to be scheduled separately. If you don’t have enough or you need to conserve auxiliary relay circuits, you can program up to eight (8) “Feature Circuits.” If a feature circuit is scheduled, it must be turned on from the control panel “Feature Circuits” menu to allow the schedule to run (see page 17).

Schedules

To create a schedule for your spa or pool:

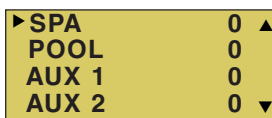
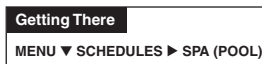

Right button: Select the **Spa** or **Pool** circuit. You can also select any of the available circuits. The generic circuit names are: Spa, Pool, Aux 1-7 and Aux Extra. Aux Extra is only available if the Solar output (J17) plug on the EasyTouch motherboard is not being used for solar equipment. Use the Solar button to switch the “extra” circuit on and off (see page 5).

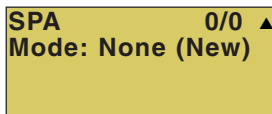

Right button: Select **Mode** if there are existing programs. Skip this step to create a new program.

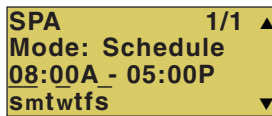

Up/Down button: Select **New** to create a new program.

Right button: To create a new program and enter the “Mode” settings.

Up/Down button: 1/1 indicates that this circuit has one program. If there are existing programs assigned to this circuit, use these buttons to view and select the existing program settings.

Right button: To select the “Schedule” settings.

Right button: Select start and stop time settings.

Up/Down and Right buttons: Set start and stop hour (A/P), minutes. The A (AM) and P (PM) time is set when setting the start and stop hour.

Right button: Select the days of the week to run the program.

Right and Up/Down buttons: By default the program is set to run all the days of the week. If you wish to edit which days to run the program, select the day of the week, then press the **Up/Down** button to remove the bar from the top of the letter. A bar on top of the letter indicates the day selected to run the program.

Press the **Menu** button to save the settings and to return to the Schedules menu options. Press the button again to return to the main menu options or press again to return to the main screen.

Setting the Egg Timer Feature

The “Egg Timer” feature lets you manually switch on equipment and program the system to automatically switch off after a specified time. You can set this timer feature for other equipment such as lighting, spa, or spa jets. Equipment can be set to be on for one minute or 24 hours. The Egg Timer program is factory set to switch off after 12 hours. You also have the option to use the “Don’t Stop” feature to run a circuit continuously until manually switched off.

Please note that in the event of a power failure, the Egg Timer feature will not switch the circuit back on. Use the “Service” mode button to turn the equipment back on. Refer to “Mode button,” page 4 for details.

***Note:** When running the filter pump continuously during a new pool start up, it is recommended to use the “Service” mode, which will automatically restart the filter pump in the event of a power failure.*

To set the Egg Timer feature:

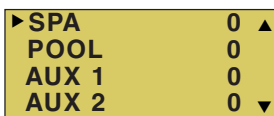
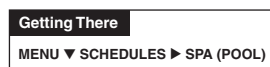

Right button: Select the **Spa** or **Pool** circuit. You can also select any of the available circuits. The generic circuit names are: Spa, Pool, Aux 1-7, Feature 1-8 and Aux Extra. Aux Extra is only available if the Solar output (J17) plug on the EasyTouch motherboard is not being used for solar equipment. Use the Solar button to switch the “extra” circuit on and off (see page 5).

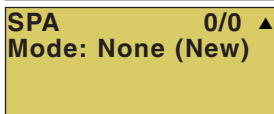

Right button: Select **Mode** if there are existing programs. Skip this step to create a new program.

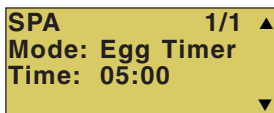

Up/Down button: Select **New** to create a new program.

Right button: To create a new program and enter the “Mode” settings.

Up/Down button: 1/1 indicates that this circuit has one program. You create a total of 12 programs. If there are existing programs assigned to this circuit, use these buttons to view and select the existing program settings.

Right button: To select the “Egg Timer” settings.

Right button: Select the time settings.

Up/Down and Right buttons: Set the hour and minutes for the program to run. The count down time can be set from 00:01 to 23:59 and Don’t Stop. The “Don’t Stop” feature allows the circuit to run continuously until manually switched off.

Press the **Menu** button to save the settings and to return to the Schedules menu options. Press the button again to return to the main menu options or press again to return to the main screen.

Setting up Compool/EasyTouch Upgrade System

Setting up the Compool/EasyTouch Upgrade System for the First Time

Use the following steps to setup up the Compool EasyTouch Upgrade system for the first time.

1. Set the system date and time (page 31)

Set the current date and time.

2. Assign circuit names (pages 37)

Assign the generic default circuit names for output auxiliary equipment. Rename (if necessary) and assign circuit names to the auxiliary (AUX 1, AUX 2) connections. Note the factory set auxiliary names correspond to the plug-in location of the relay on the EasyTouch motherboard. Assign circuit names from the available of circuit names. There are nearly 100 circuit names available (see page 38 for the complete list).

3. Creating custom names for auxiliary circuits (page 41)

If you cannot find a circuit name that fits your application you can create up to 10 additional customized names that can be created before assigning circuit names.

4. Assign a “Circuit Function” to a “Circuit Name” (Page 39)

Assign “Circuit Functions” to circuits. From the “Circuit Function” menu (page 39), you can assign special logic to a circuit by selecting one of the available circuit functions. For the complete list of preset Circuit Functions see page 40. If an auxiliary circuit (AUX) is assigned GENERIC (simple ON/OFF when the button is pushed) then nothing needs to be done.

5. Configure valve actuators (controlled by AUX circuit) (page 41)

The EasyTouch system can drive two auxiliary valve actuators for applications such as solar heating and water features. Assign which circuits that will activate valves A and B. Auxiliary valve actuators can be controlled by any AUX circuit. Valve A is automatically assigned to solar if “Solar” is enabled in the “Solar” menu.

6. Set up optional equipment, solar, two-speed pump (page 42)

Set up additional equipment such as solar, 2-speed pump, and optional equipment if required. Set up the control panel to operate with the optional IntelliChlor chlorine generator (see page 35). To configure EasyTouch for special equipment:

- Is solar heating available? Is solar being used for a heat pump?
- What circuits will turn 2-Speed pumps to High Speed?
- Cool-down cycle for the heater - Lets you set circuits that switch the filter pump to high speed.
- Do you want to delay turning off the filter pump for 10 minutes when the heater is turned off?
- Do you want the spa to heat whenever the Spa button is pressed?

7. Configuring the heater system options (page 25)

Set the type of heat source being used (Heater, Solar, Solar Preferred).

8. Configure the iS4, iS10 spa-side remote, QuickTouch wireless remote buttons (page 44)

Assign circuits to the iS4, iS10 or QuickTouch remote buttons. Once you have checked that all buttons operate properly, place labels on remote buttons.

9. Set the delays feature (page 43)

Enable the one time “delay” feature for the heater, 2-speed pump, and automatic pool cleaner.

10. Schedule on/off times for circuit (page 27 - 30)

Set times for automatic circuit activation. Up to 12 total programs can be created for all circuits combined.

One circuit can have up to a maximum of 9 programs (9/9), which leaves 3 programs that can be used by one circuit or three separate circuits for a total of 12 programs. All user created programs are active all the time; so check that there are not conflicting automated times.

11. Setup the lighting settings (page 18)

From the lighting menu you can enable special control of your pool and yard lighting, such as rotating colored lights, and synchronized colored lights.

EasyTouch Menus

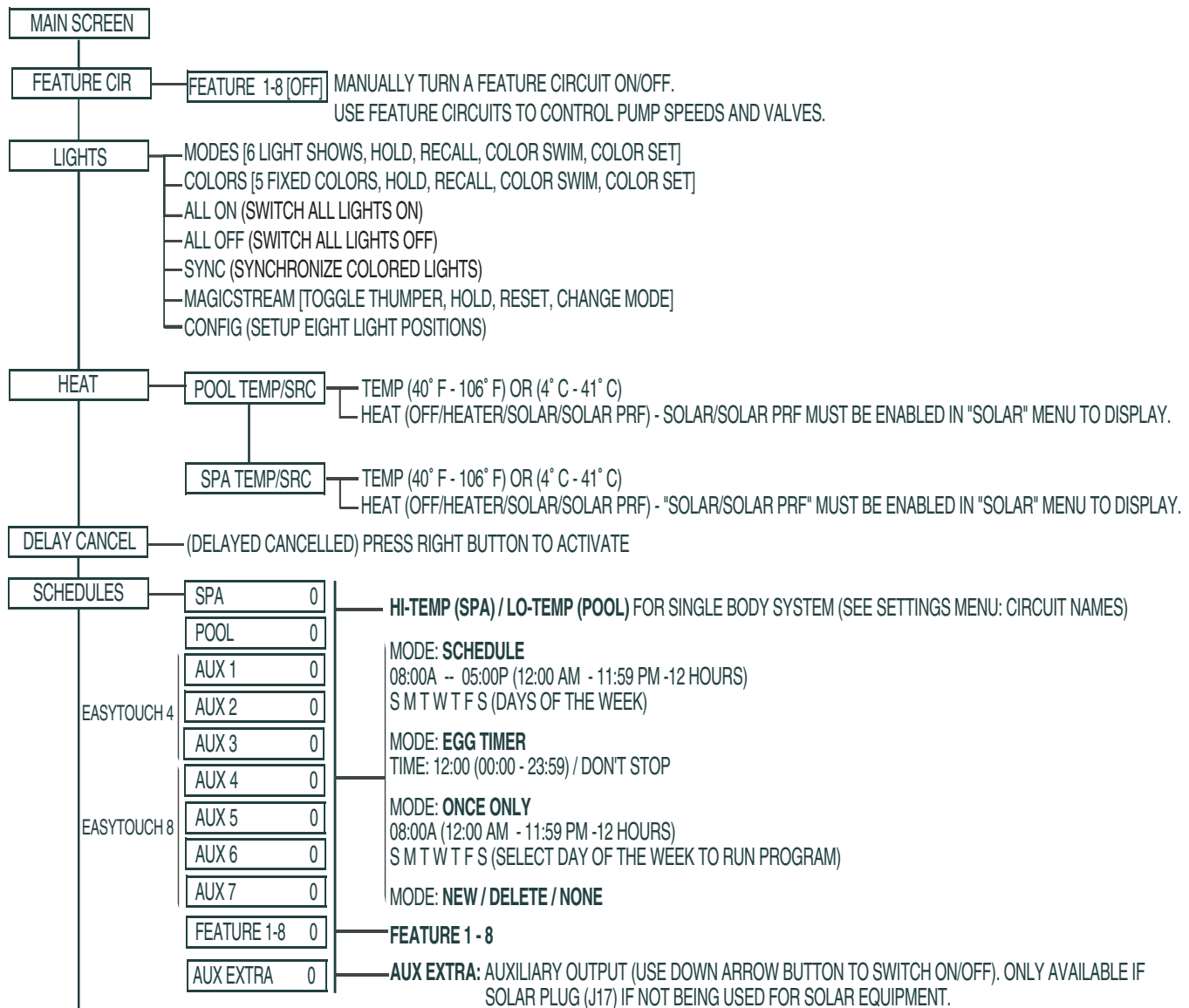

EasyTouch Menus (Continued)

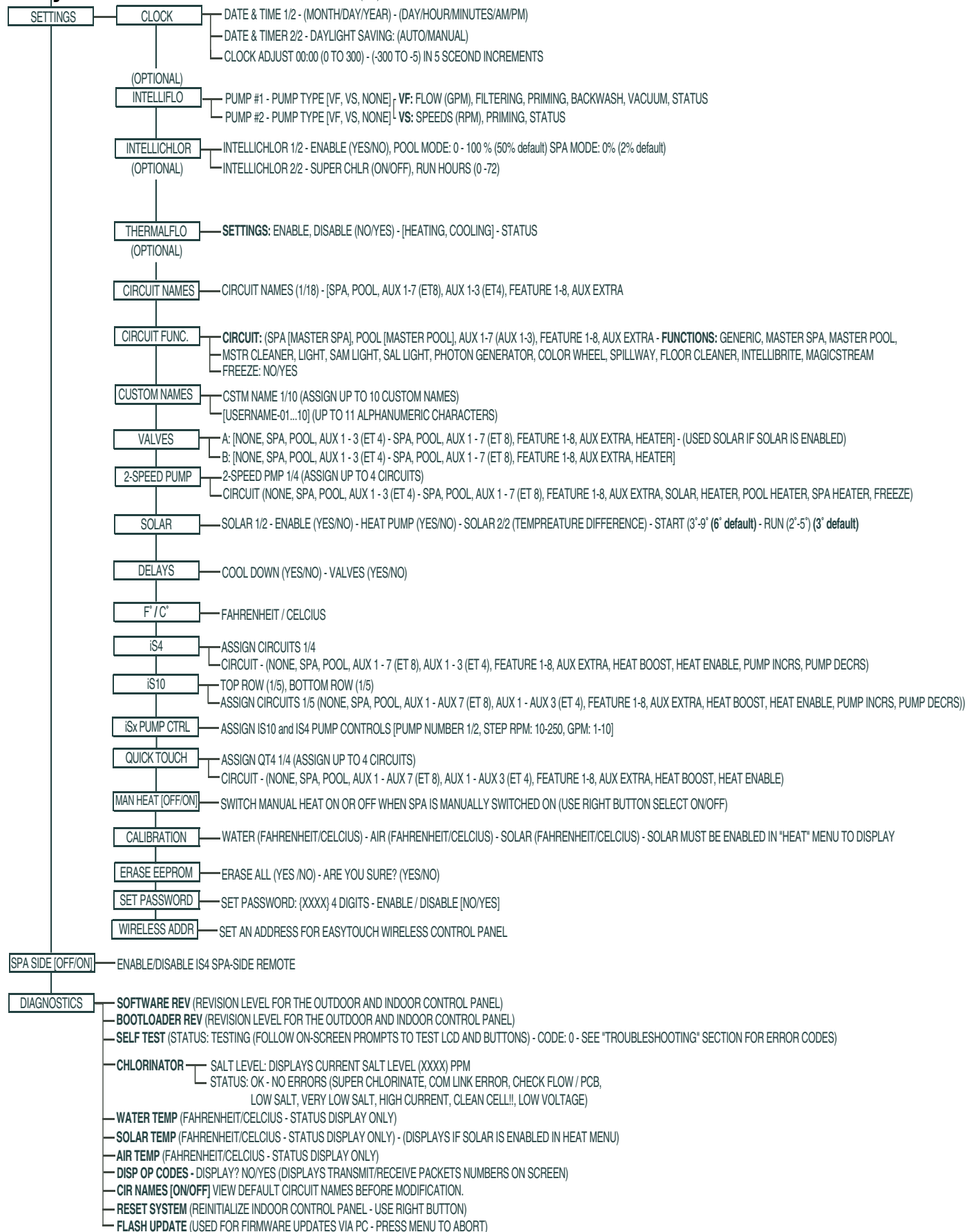

EasyTouch Menus

From the EasyTouch control panel menus you can schedule everyday pool/spa, heating, filtration and cleaning. Lights and laminars can also be scheduled to switch on and off at specific times. The “Settings” and “Schedule” menus are typically used most often for daily spa and pool operations. The “Settings” menu is used by the pool installer to setup installed equipment which is connected to each output relay (filter pump, auxiliary relays, heater, valves, lights, etc.). For EasyTouch equipment installation instructions, see the EasyTouch Installation Guide (P/N 520584).

Main Screen

AUTO	HEATER
SPA 95°F / 100°F	
AIR 70°F	
MON 09:30 AM	

AUTO	HEATER
POOL 85°F / 95°F	
AIR 70°F	
MON 10:30 AM	

AUTO	
AIR 70°F	
MON 11:30 AM	

The EasyTouch main screen displays the current mode of operation (AUTO/SERVICE/TIMEOUT), heat source being used, spa (or pool) actual water temperature (95° F), current heater set point temperature (100° F) and the current ambient air temperature (air sensor). Degree units can be displayed in either Fahrenheit (default) or Celsius (see page 44). If the second display line is blank and the heat source is not displayed, there is no spa or pool function currently active. The main screen is automatically displayed if there is no control panel menu activity for five minutes. If there is an IntelliChlor salt chlorinator generator being used, pool and spa sanitizer settings, and salt levels can be viewed in the Diagnostics, “Chlorinator,” settings (see page 53).

Main Screen Description

AUTO: EasyTouch is in normal (automatic) operating mode. For information about “Service” and “Timeout” operating modes, see page 4.

HEATER: The selected heat source as selected in the “Heat” menu (see page 25). The heat options are:

- **OFF** - No heating even though pump and other circuits may be operating.
- **HEATER** - Gas heater only.
- **SOLAR ONLY** - Solar heating system to be the only heat source. In order to display “Solar Pref.” on the main screen, you must first enable solar in the “Solar” menu (see page 42).
- **SOLAR PREF.** - (Solar Preferred) - For when solar and gas heating are combined, and you want to use solar heating only when it is most effective. In order to display “Solar Pref.” on the main screen, you must first enable solar in the “Solar” menu.

SPA: “SPA” is displayed after the **Valves (V)** button is pressed to set in “spa” mode then the **Filter (F)** button is pressed to switch the filter pump on, rotate the valve actuator (to isolate spa water from pool water), and switch the heater on (if enabled in the “Heat” menu). Pressing the **Valves (V)** button alternates between “Pool” and “Spa” mode. The temperature unit displayed on the left side is the actual water temperature (95° F) and the set point temperature (100° F) as set in the “Heat” menu is displayed on the right side. If this display line is blank, it indicates no spa or pool function is currently active. For Hi-Temp controls (EasyTouch single body system), see page 37.

POOL: “POOL” is displayed after the **Filter (F)** button is pressed to switch the filter pump on, rotate the valve actuator to isolate the pool water from the spa water, and switch the heater on (if enabled in the “Heat” menu). Pressing the **Valves (V)** button alternates between “Pool” and “Spa” mode. The temperature unit displayed on the left side is the actual water temperature (95° F) and the set point temperature (100° F) as set in the “Heat” menu is displayed on the right side. If this display line is blank, it indicates no spa or pool function is currently active. For Lo-Temp controls (EasyTouch single body system), see page 37.

AIR: Displays the actual outside ambient air temperature (70° F) as recorded by the air sensor located near the EasyTouch load center.

DAY and TIME: The current system day and time (AM/PM). See the “Clock” menu to set the system day and time (page 31).

Feature Circuits Menu

There are eight (8) “Feature Circuits” that can be used to control IntelliFlo pump speeds or valves actuators for a spa spillway. Unlike an auxiliary relay circuit, a “Feature” circuit does not connect directly to a relay. “Feature” are turned on and off from the control panel “Feature” circuit menu.

Feature Circuits



To switch a feature circuit ON or OFF:

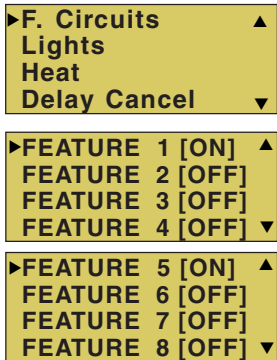

Right button: Select the feature circuit to turn ON or OFF.
Up/Down buttons: Choose assigned feature circuit: FEATURE 1 - 8.
Right button: Switch the selected feature circuits ON or OFF.

When finished, press the **Menu** button twice to return to the main screen.

Lights Menu

From the Lights screen you can manually switch all lights on or off, and synchronize colored lights. Up to eight (8) lights can be independently controlled from the **Lights** screen. Each light requires a separate auxiliary relay circuit. Up to four lights can be assigned on each auxiliary circuit. A circuit name must be assigned to the AUX relay circuits which controls the light. Verify that IntelliBrite, *SAm* and/or *SAL*, and/or *FIBERworks* have been selected in Circuit Function. If *FIBERworks* lighting is being used, it also has to be set up as a Photon Generator® light source (PHOTON GENERATOR) for the circuit controlling the light bulb, and COLOR WHEEL for the circuit controlling the color wheel. For more information about setting up lights, see “Settings Menu: Circuit Function,” on page 39.

The Color Swim and Color Set Lighting Features

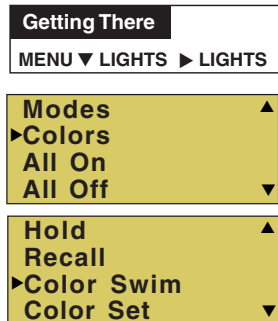

The Color Swim and Color Set lighting features is selected from the **LIGHTS > MODES** and (**COLORS**) menu. At least two (2) Pentair Water Pool and Spa®, IntelliBrite®, *SAm*®, *SAL*®, and/or *FIBERworks*® lighting systems are required to use the lighting features.

- **Color Swim** - Select the Color Swim feature in the **MODES** and **COLORS** menus to start lights to transition through colors in sequence to give the appearance of colors dancing through the water. You can adjust the delay of each light to make the colors move at different speeds using the **LIGHTS > CONFIG** option. This lighting feature requires a separate relay for each light. To switch off the Color Swim feature, select the AUX button assigned to the light circuit or select ALL OFF in the Lights menu.
- **Color Set** - Select the Color Set feature in the **MODES** and **COLORS** menus to switch the light on using specific color as selected in the **COLORS** menu. This feature requires a separate relay for each light. To switch off the Color Swim feature, select the AUX button assigned to the light circuit or select ALL OFF in the Lights menu.
- **Configure** - Select “Configure” to setup the positions of the lights the pool. Up to eight (8) lights can be assigned a position. For more information see page 22.



- **Sync** - Select the Sync feature in the **LIGHTS** menu to switch on all IntelliBrite, *SAm*, *SAL*, or *FIBERworks* color changing lights and synchronize their colors.
- **Smart Start (SS: Yes/No)** - Select Smart Start in the Schedules menu (see page 27). The Smart Start feature automatically starts changing colors when the lights are programmed to switch on. Smart Start is used when Color Swim and IntelliBrite show modes are being used.

Setting up Lights

The following section describes how to assign a light circuit name and function to control Pentair Water Pool and Spa IntelliBrite, *SAM* and/or *SAL*, and/or *FIBERworks* lights.

Assign the Light Circuit Name and Function

The first step in setting up a light circuit is to assign a name to the relay circuit (example; AUX 3, as “Pool Light”), then assign the name “Pool Light” circuit in the Circuit Func. menu as a “light” circuit (IntelliBrite, SAM, SAL..). The light circuit functions are: Light, SAM, SAL, Photon Generator, Color Wheel, Spillway, MagicStream and IntelliBrite (see page 40). After assigning the circuit name and function, the light circuit name “Pool Light” can be setup in the CONFIG menu for light position, color etc.

To assign a circuit function:



Up/Down buttons: Select the circuit number 1/18. Press the **Up button** two times to select AUX 1 to choose this circuit for a light circuit On/Off button. The generic circuits names are: Spa, Pool, Aux 1-7, FEATURE 1-8 (Ft. 1-8), AuxX (Aux Extra). The circuit number (1/18) corresponds to its assigned circuit name.

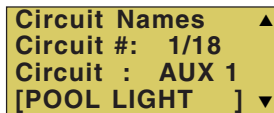

Right button: Select the EasyTouch preset circuit names and user defined custom circuit names.

Up/Down buttons: Scroll through the list of preset names (see page 38 for a complete list of circuit names). Select a name that describes where the light is located or that suits the function, such as “Pool Light.” AUX 1 has now been assigned the circuit name “Pool Light.” If you cannot find a name to match your circuit, you can create your own custom name (see page 41). Repeat this step for all the circuit buttons that you wish to assign names to. “Aux Extra” is only available if the Solar output (J17) plug on the EasyTouch motherboard is not being used for solar equipment. The **Down arrow button** is used to turn the “extra” circuit on and off.

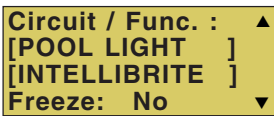

Press the **Menu** button to return to the Settings menu. Press the Down button to and select “Circuit Func.” Press the **Right button** to access the Circuit Func. menu.

Up/Down buttons: Select the already assigned circuit name “Pool Light.”

Right button: View “Circuit Functions” to assign to light circuit “Pool Light.”

Up/Down buttons: Select the type of light circuit function to use. The circuit function names are: LIGHT, SAM LIGHT, SAL LIGHT, PHOTON GEN, COLOR WHEEL, VALVE, SPILLWAY, FLOOR CLEANER, INTELLIBRITE, MAGICSTREAM, GENERIC, and MSTR CLEANER. For a complete list of preset circuit functions, see “Preset Circuit Functions” on page 40.

Note: To use the “Color Swim” or “Color Set” feature, select IntelliBrite, SAM, SAL, Photon Generator or Color Wheel. Select “MagicStream” for MagicStream laminars.

Press the **Menu** button three times to return to the main screen.

Setting up lights

From the Lights screen you can manually switch all lights on or off, synchronize colored lights, and activate color light shows. Up to eight light circuits can be configured from the “Config” light menu. Each light must have its own relay and separate circuit.

Setting up IntelliBrite Light Circuits

Before configuring the lights, be sure the auxiliary (AUX) circuits that control the IntelliBrite lights have been assigned as an “IntelliBrite” light. For more information about “Circuit Functions” (page 39) and “Circuit Names,” (page 37).

Lights Menu

To access the Lights menu screen, press **Menu > Lights**. The Lights menu settings are: MODES, COLORS, ALL ON, ALL OFF, SYNC, MAGICSTREAM, CONFIG:



Modes (IntelliBrite Color light shows, Color Swim, Color Set)

To access the Modes menu, press **Menu > Lights > Modes**. There are six pre-programmed color light shows to choose from. From the “Modes” screen you can select various preset show color lighting effects, such as “American mode” and “Sunset mode”, “Color Swim” or “Color Set.” Using the “Hold” and “Recall” feature (see page 21) you can also capture and save a unique color light show effect to recall at a later time.

The IntelliBrite color “Mode” settings light shows are:

- **Party:** Rapid color changing building the energy and excitement
- **Romance:** Slow color transitions creating a mesmerizing and calming effect
- **Caribbean:** Transitions between a variety of blues and greens
- **American:** Patriotic red, white and blue transition
- **Sunset:** Dramatic transitions of orange, red and magenta tones
- **Royalty:** Richer, deeper, color tones

IntelliBrite Light: If the IntelliBrite light was not previously on, after selecting a color show mode, no illumination will occur for up to ten (10) seconds (depending on the selection), then a white light will momentarily illuminate, followed by the color show mode selection. If the light was previously on, selecting the a color show mode button will momentarily illuminate the previously selected color before changing to the selected color show.

Modes (Color Swim)

The Color Swim feature cycles through white, magenta, blue and green colors. Using IntelliBrite lights, Color Swim emulates the Pentair Water Pool and Spa SAM and SAL Color Swim feature.

IntelliBrite Light Color Swim/Color Set: If the light was not previously on, after selecting Color Swim, no illumination will occur for approximately six (6) seconds followed by the selection. If the light was previously on, after selecting the Color Swim feature, the previously selected color will momentarily illuminate, no illumination will occur for approximately six (6) seconds followed by the selection.

Setting up lights (Continued)

Modes (Color Set)

The “Color Set” feature allows any combination of up to eight IntelliBrite lights, and Pentair SAm, SAL and or Fiberworks lighting to be preset to specific colors. Fixed light colors are selected and activated from the Colors screen.

IntelliBrite Light: *If the light was not previously on, after selecting the fixed colored light, no illumination will occur for approximately six (6) seconds followed by the selection. If the light was previously on, after selecting the colored light, the previously selected color will momentarily illuminate, no illumination will occur for approximately six (6) seconds followed by the selection.*

Colors

Choose any one of the five fixed colors to create a spectacular underwater lighting effect. The fixed colors are: **Blue, Green, Red, White** and **Magenta**. You can switch each fixed colored light on or off from the Colors screen.

IntelliBrite Light: *If the light was not previously on, after selecting a fixed colored light, no illumination will occur for up to ten (10) seconds (depending on the selection), then a white light will momentarily illuminate, followed by the color selection. If the light was previously on, selecting the a color button will momentarily illuminate the previously selected color before changing to the selected color.*

To select a fixed color press: **Menu > Lights > Modes > Colors:**

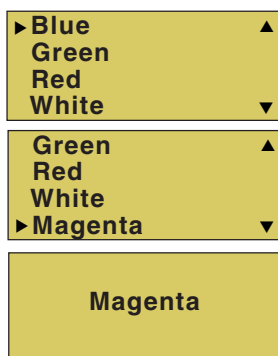

Up/Down buttons: Choose a color for the light.

Right button: Switch the selected colored light ON. To switch the light off, go to the main Lights menu and select **All Off**, or press the AUX button assigned to the light. The AUX button will also switch the light on.

Press the **Menu** button three times to return main menu.

⚠ WARNING - IntelliBrite Lights: During the off/on switching process, before the selected color is displayed, no illumination will occur. This operating mode is normal during the switching process. During this period the pool and spa will be dark and precautions should be taken to avoid unforeseen accidents. Failure to observe this warning may result in serious injury or death to pool and spa users.

Hold/Recall

Select Hold and Recall from the “Modes” or “Color” screen to capture and save a unique color effect and recall it at a later time. For example, while a light show (Romance Mode) is active, select “Hold” to save the exact colors that are being displayed, then later, to recall the exact color effect, select “Recall.”

Note: *After selecting Hold or Recall, no illumination will occur for up to 10 seconds, then a white light will momentarily illuminate, followed by the saved color.*

All On / All Off (Lights Menu)

Select **All On** or **All Off** from the Lights screen to manually switch all lights on or off, including any MagicStream laminar circuits. Press the control panel auxiliary button (AuxX) assigned to a light circuit will also switch a light on or off.

Sync

Select **Sync** from the “Lights” screen to synchronize colors for all IntelliBrite, SAm, SAL and FIBERworks color changing lights.

Setting up lights (Continued)

Config

From the “Config” screen you can setup the IntelliBrite light position, and specify the color of each pool and spa light. Any combination of up to eight IntelliBrite lights, Pentair SAM, SAL and or Fiberworks lights can be preset for specific colors and position when using the “Color Swim” and “Color Set” feature. Fixed light color are selected and activated from the Colors screen. *Note: The “Config” menu settings do not apply to the MagicStream laminars.*

To select configure a light position and color: **Menu > Lights > Config:**

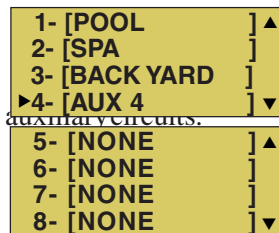

Up/Down buttons: Choose the light circuit (1-8) to configure. Select an available auxiliary circuit (NONE). For more about assigning an auxiliary circuit to a light, see “Circuit Functions (page 39) and “Circuit Names” (page 37). Up to eight (8)

Right button: Select the light to setup.

Up/Down buttons: Select the light circuit.

Right button: Select the light color selection.

Up/Down buttons: Select the light color (**Blue, Cyan, Green, Lt. Green, White, Lt. Magenta, Magenta, Lavender**).

Right button: Select the light position selection.

Up/Down buttons: Select the light position. A light can be assigned to any position from 1 through 12. To ensure that the “Color Swim” and “Color Set” lighting feature color effects are correct, set the position of the light according to where it’s located in the pool or spa. **Position 1** will lead all the other lights in the color changing sequence. **Position 2** follows Position 1 and so on. There are 12 position to choose from. More than one light may be assigned to the same position number so that their colors may be synchronized. For example, to make the colors swim right to left, make your right most light Position 1. You may need to go back to and scroll through your lights to find the right most light, and set it as Position 1.

Right button: Select the light delay selection. The Delay time between two or more lights can be set from 0 to 60 seconds. Use a higher delay time for lights spread further apart. Try five seconds for all lights and observe the effect. Use different time settings to achieve unique lighting moods and effects.

Press the **Menu** button to setup other lights or press Menu button four times to return main screen.

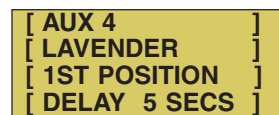

Setting up SAM, SAL, PG2000, Color Wheel Lights

Before using the lighting feature “Color Swim” or “Color Set” with Pentair SAM or SAL lights, make sure the AUX relay circuits which control the lights have been assigned as “light” circuit and that the name (AUX 1, AUX 2) has been changed to best fit the light being used. Verify that *SAM* and/or *SAL*, and/or *FIBERworks* have been assigned in “Circuit Functions” as SAM or SAL light. If *FIBERworks* lighting is incorporated, it also has to be set up as a “PHOTON GENERATOR” light for the circuit controlling the light bulb, and COLOR WHEEL for the circuit controlling the color wheel it self. The circuit light “functions” are: Light, SAM, SAL, Photon Generator, Color Wheel, and IntelliBrite, see page 40 for a more information.

Setting up MagicStream Laminars

The MagicStream® Laminar provide a clear, turbulence-free stream of water that is lit with a fiber optic cable, or an LED light for a dazzling nighttime effect. The 12 VAC powered LED light can generate a series of multicolored light shows, or can be set to display a continuous, single color. If desired, the built-in solenoid “thumper” can create a random “wrinkle,” in the Laminar’s stream, causing it to display a brilliant spot of light that moves along the stream’s arc. The light enhancer can be adjusted to maximize the light in the arc.

Up to twelve (12) MagicStream Laminar circuits can be displayed on the main Lights screen, assuming each laminar has its own relay and separate circuit.. From the Lights screen you can activate the MagicStream laminars (changing color modes, turn Thumper on/off, Hold and Reset). For more information, see the MagicStream Installation Guide, P/N 520969.

Setting up MagicStream Laminar LED Lights

To setup MagicStream laminar circuits, first assign each laminar auxiliary relay circuit a circuit name (see “Circuit Names” page 37, then assigned the laminar relay circuit name to “MAGICSTREAM” in the circuit functions menu (Circuit Func.).

To setup the MagicStream laminar circuit names and function:

Getting There
MENU ▼ SETTINGS ▼ CIRCUIT NAMES ►

IntelliFlo ▲
IntelliChlor ▲
►Circuit Names
Circuit Func. ▼

Up/Down buttons: Select the circuit number 1/18. Press the **Up button** two times to select AUX 1 to choose this circuit for the MagicStream circuit On/Off button. The generic circuits names are: Spa, Pool, Aux 1-7, FEATURE 1-8 (Ft. 1-8), AuxX (Aux Extra).

Circuit Names ▲
Circuit #: 1/18
Circuit : AUX 1
[STREAM] ▼

The circuit number (1/18) corresponds to its assigned circuit name.

Right button: Select the EasyTouch preset circuit names and user defined custom circuit names.

Up/Down buttons: Scroll through the list of preset names (see page 38 for a complete list of circuit names). Select a name that describes where the MagicStream laminar is located or that suits the function, such as “Stream.” AUX 1 has now been assigned the circuit name “Stream.” for the first MagicStream laminar. Repeat this step for the next laminar circuit. If you cannot find a name to match your circuit, you can create your own custom name (see page 41). “Aux Extra” is only available if the Solar output (J17) plug on the EasyTouch motherboard is not being used for solar equipment. The **Down arrow button** is used to turn the “extra” circuit on and off.

Getting There
MENU ▼ SETTINGS ▼ CIRCUIT FUNC. ►

Press the **Menu** button to return to the Settings menu. Press the Down button to and select “Circuit Func.” Press the **Right button** to access the Circuit Func. menu.

Circuit / Func. : ▲
[STREAM]
[MAGICSTREAM]
Freeze: Yes ▼

Up/Down buttons: Select the already assigned circuit name “Stream.”

Right button: View the “Circuit Functions” to assign to laminar circuit “Stream.”

Up/Down buttons: Select the type of circuit function to use, in this case select “MAGICSTREAM.” The circuit function names are: LIGHT, SAM LIGHT, SAL LIGHT, PHOTON GEN, COLOR WHEEL, VALVE, SPILLWAY, FLOOR CLEANER, INITELLIBRITE, MAGICSTREAM, GENERIC, and MSTR CLEANER. For a complete list of preset circuit functions, see “Preset Circuit Functions” on page 40.

Right button/ Up Button: Turn “Freeze” protection ON.

Press the **Menu** button three times to return to the main screen. *Continue on next page...*

Using the MagicStream Laminar Features

The MagicStream laminar features are displayed in the MagicStream menu. Each time a MagicStream feature is activated, MagicStream resumes with the same features in operation as when last switched off. The MagicStream features are as follows:

Toggle Thumper - Pressing this button creates a "wrinkle" in the laminar stream, producing a brilliant spot of light in the laminar arc.

Hold - Select Hold to capture the current color effect while colors are changing. The colors will stop changing. Selecting Hold again will resume the color changing mode.

Reset - Pressing this button reverts to the **Random** color changing mode with the Thumper ON.

Change Mode - Pressing this button (each successive OFF/ON combination) will cycle through **Sync**, **Random** and **Party**. Color changing mode - The color of the light changes automatically, according to one of the following three programs:

Sync - Colors will change at ten second intervals. In this mode, multiple laminars will synchronize colors together. Note: To sync multiple laminars (two or more AUX circuits), be sure to define the "MagicStream" circuits in the "Circuit Functions" menu.

Random - Colors will change at ten (10) second intervals in a random sequence. In this mode, multiple laminars will NOT synchronize colors together.

Party - Colors will change randomly and slowly at first, then speed up, until the sequence ends with quick flashes and strobes. The sequence then repeats, beginning with the slow changes. In this mode, multiple Laminars will NOT synchronize colors together.

To access the MagicStream laminar features:

Getting There	
MENU ▼ LIGHTS ► LIGHTS	
All On ▲ All Off Sync ► MagicStream ▼	Down button: Choose MagicStream. Right button: Select MagicStream . Up/Down button: Select the desired MagicStream features.
Toggle Thumper ▲ Hold Reset ► Change Mode ▼	Right button: Use this button to activate the selected MagicStream feature. After the button is pressed, the following screen displays the name of the selected feature (indicating that the MagicStream feature has been activated) then returns to the MagicStream feature menu.
Change Mode	Press the Menu button three times to return to the main screen.

Heat Menu

Use the heat menu settings to specify the set point temperature and select the heat source for the pool and spa water. The water will begin to heat whenever the heater is manually switched on, (by pressing the Valves (V) button (on the Outdoor Control Panel) or the “Pool” or “Spa” button on the Indoor Control Panel), even if the heater is set to off. The spa will also begin to heat when switched on by the optional iS4/iS10 Spa-Side remote, or EasyTouch wireless remote. The EasyTouch system allows for solar and conventional heaters. The EasyTouch will use the heating source that is selected. The heat source selections are:

- **OFF** - No heating even though pump and other circuits may be operating.
- **HEATER** - Gas heater only. Use the Heater button to automatically switch the heater on which controls the output between a “forced off” state and a normal, automatic thermostatic control operating state. The heater will continue heating the water until the heater’s current highest set point temperature triggers the heater sensor (approximately 104° F or 40° C). Note that the Heater button on the control panel does not activate the pump. Do not activate the heater without running the pump. The heater will not run if water flow is not detected.
- **SOLAR ONLY** - Solar heating system to be the only heat source. In order to display “Solar Pref.” on the main screen, you must first enable solar in the “Solar” menu (see page 42).
- **SOLAR PREF. (Solar Preferred)** - Solar and gas heating systems are installed, and you want to use solar heating only when it is most effective. In order to display “Solar Pref.” on the main screen, you must first enable solar in the “Solar” menu. To set the spa temperature and select the heat source:

Pool Temp/Src

Getting There

MENU ▼ HEAT

To set the pool temperature and select the heat source:

▶ POOL Temp/Src ▲ SPA Temp/Src ▼	Right button: Select pool temperature and heater options. Up/Down button: Set the pool temperature (from 40° F to 104° F). Right or Left button: Select Heater options.
POOL ▲ Temp: 72° F Heat: Off ▼	Up/Down: Set Heater option: Off, Heater, Solar, or Solar Preferred. Press the Menu button to save the settings and to return to the previous menu or press the button again to return to the main screen.

Spa Temp/Src

To set the spa temperature and select the heat source:

▶ POOL Temp/Src ▲ SPA Temp/Src ▼	Right button: Select spa temperature and heater options. Up/Down button: Set the spa temperature (from 40° F to 104° F or 4° C to 40° C). Right or Left button: Select Heater options.
SPA ▲ Temp: 85° F Heat: Off ▼	Up/Down: Set Heater option: Off, Heater, Solar, or Solar Preferred. Press the Menu button to save the settings and to return to the Heat menu or press the button again to return to the main screen.

Note: For an EasyTouch single body system, “Pool” and “Spa” modes are Lo-Temp (Pool) and Hi-Temp (Spa) temperature controls. For more information, see “Hi-Temp/Lo-Temp Controls for Single Body Systems,” on page 37.

Delay Cancel Menu

Use the Delay Cancel feature for service or testing purposes. For convenience, on a onetime basis, the Delay Cancel feature will cancel the following safety delays. Please note, generally there is no need to cancel any of the following delays except for servicing or testing the system.

- **Heater Cool-Down Delay Cancel:** Shuts Filter Pump off immediately.
- **2-Speed Filter Pump five-minute START on HIGH SPEED Delay Cancel:** Shifts pump to low speed.
- **Automatic Pool Cleaner START Delay:** Starts Cleaner Pump immediately, without normal delay in which the filter pump first runs for 5 minutes.
- **Automatic Pool Cleaner SOLAR Delay:** Allows Cleaner Pump to run even though solar delay has shut it off for 5 minutes.

Some heaters require a cool-down cycle before being switched off. This can be setup in the menu to run the filter pump an additional ten minutes to dissipate residual heat built up inside the heater combustion chamber. The Delay Cancel feature is mainly for use by service technicians when it's necessary to shut the filter pump off immediately, and know the heater has not been running. Heaters manufactured by Pentair Water Pool and Spa do not require this cool-down period and do not need the delay to be set up.

Note: For Information about assigning delays to the pool and spa valves, refer to “Settings Menu: Delays” on page 43.



Delay Cancel

To activate Delay Cancel:

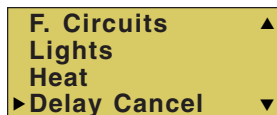

Up/Down button: Select Delay Cancel.

Right button: Use this button activate Delay Cancel for one time only. “Delay Cancelled” is displayed after pressing the Right button.

Press the **Menu** button to return to the main screen.

Schedules Menu

Use the Schedules menu to create programs to schedule start and stop times to automatically run equipment, such as pumps and lights. Any circuit can be programmed to switch on and off at a specific time on every or any specific day of the week. The number of programs that can be created for circuits are as follows:

- Up to 12 total programs can be created for all circuits combined.
- One circuit can have up to a maximum of 9 programs (9/9), which leaves 3 programs that can be used by one circuit or three separate circuits for a total of 12 programs.

Using the Schedules menu

Use the Schedules menu features to program operating schedules for the pool, spa and auxiliary circuits:

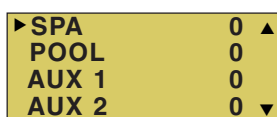

Choose the circuit to program

Up/Down button: Select the generic circuit name to program: Spa, Pool, Aux 1-7, Feature 1- 8, Aux 1-3 and Aux Extra. Aux Extra is only available if the Solar output is not being used. See Solar button on page 5 for details.

The current number of programs for each circuit is displayed opposite the circuit name. A circuit can have up to 9 programs (9/9). Three additional programs can be assigned to another circuit or three separate circuits for a maximum of 12 programs.

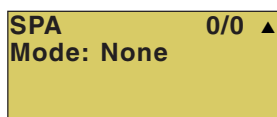

Create a new program

The current number of programs for each circuit is indicated opposite to the circuit name. 0/0 indicates no programs assigned to this circuit.

Right button: Select “Mode” selection.

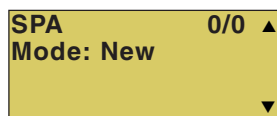

Up/Down button: Select **New** to create a new program. Use “None” when a circuit has existing programs and you wish to exit the “Mode” selections without modifying the existing programs.

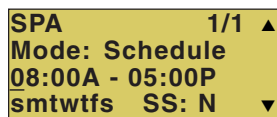

Choose the type (Mode) of program to run

After selecting “New” the current program number (1/1) for this circuit is displayed.

Right button: Select “Mode” selection.

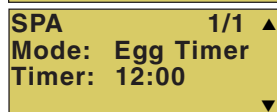

Up/Down button: Choose the program to run: **Schedule, Egg Timer, Once Only, New, Delete, and None**. If there are existing programs assigned to this circuit, use these buttons to view and select the existing program settings.

Mode Selection:

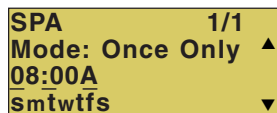

Schedule: Set start, stop times and the day(s) of the week to automatically switch pool/spa circuits on or off. Default run time for the “Schedule” feature is 8:00 AM to 5:00 PM. If you program the start and stop times the same the schedule is will run for 24 hours. *Note: SS: N (Smart Start) is displayed if a light circuit is being scheduled (see page 18).*

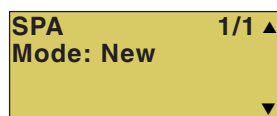

Egg Timer: A one time program that switches on a function at a specific time, and counts down the preset time to the switch off the function. After the “Egg Timer” schedule has finished, the system can be operated in manual mode. The “DON'T STOP” option allows a circuit to run continuously until its switched off manually.

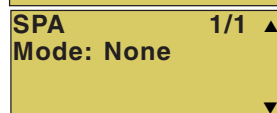

Once Only: Schedule a circuit to switch on at a particular time on a onetime basis.

New: press the **Right** button to create a new program.

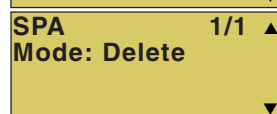

Delete: Select the program and press the **Right** button to delete it.

None: Press the **Right** button to exit the “Mode” selections without modifying the program.

Schedules Menu (Continued)

Schedule your spa/pool pump to turn on

Use the Schedule feature to set the time and day(s) when to switch the filter pump on and rotate the pool or spa valves into the “Spa” or “Pool” position. The heater will automatically heat the spa or pool water up to the set point temperature as set in the “Heat” menu (see page 25). If the pool has a separate jet pump or blower controlled by AUX 1 and/or AUX 2, these need to be scheduled separately.

Schedule Example

When a circuit relay is switched on manually, it remains on until you either switch it off manually, or the next time the relay is scheduled to be switched off. For example, if the filter pump or any circuit is scheduled to run from 9 AM to 4 PM and the programmed schedule is turned OFF at 1:00 PM and then turned on at 1:10 PM, the circuit will turn OFF at its programmed OFF time of 4:00 PM. But if the circuit is turned on after 4:00 PM, the factory set Egg Timer of 12 hours is now engaged. So if the circuit was turned on at 6:00 PM that circuit will turn off at 6:00 AM (12 hours later). If the circuit was turned ON at 5:00 PM and because a programmed OFF time had been set to turn off at 4:00 PM, the circuit would operate for 11 hours. A spa or pool program can be overridden using the Spa button or Pool button to switch the circuit on. If you program the start and stop times the same, the schedule will run for 24 hours if scheduled to run for one day. In “Service” mode, a pool or spa program can be overridden using the Filter (F) button and pool/spa Valves (V) button on the outdoor control panel in the EasyTouch load center. **Note:** *The following example describes how to use the “Schedule” feature to program the spa circuit to switch the filter pump on and rotate the valves into the “Spa” position and switch the heater on. This example can also be used to program when to filter and heat your pool, and switch light or auxiliary circuits on or off.*

To create a schedule for your spa or pool pump to turn on:

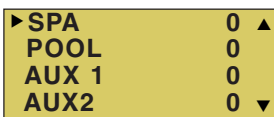

Right button: Select the **SPA or POOL** circuit. The available generic circuit names are: Spa, Pool, Aux 1-7, Feature Circuit 1-8 and Aux Extra. Aux Extra is only available if the Solar output (J17) plug on the EasyTouch motherboard is not being used for solar equipment. Use the Solar button to switch the “extra” circuit on and off (see page 5).

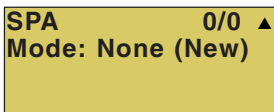

Right button: Select **Mode** if there are existing programs. Skip this step to create a new program.

Up/Down button: Select **New** to create a new program.

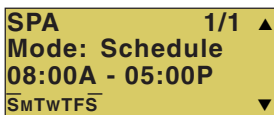

Right button: To create a new program and enter the “Mode” settings.

Up/Down button: 1/1 indicates that this circuit has one program. If there are existing programs assigned to this circuit, use these buttons to view and select the existing program settings.

Right button: To select the “Schedule” settings.

Right button: Select start and stop time settings.

Up/Down and Right buttons: Set start and stop hour (A/P), minutes.

The A (AM) and P (PM) time is set when setting the start and stop hour.

Right button: Select days of the week to run the program.

Right and Up/Down buttons: By default the program is set to run all the days of the week. If you wish to edit which days to run the program, select the day of the week, then press the **Up/Down** button to remove the bar from the top of the letter. A bar on top of the letter indicates the day selected to run the program.

Press the **Menu** button to save the settings and to return to the Schedules menu options. Press the button again to return to the main menu options or press again to return to the main screen.

Using the Once Only feature

The “Once Only” feature allows you to program a circuit to switch on at a particular time and day on a onetime basis. A typical use for this feature is to have the spa and heater switch on before you get home from work for one evening. Unlike the regular “Schedule” timer, this feature does not repeat. After this event has finished, the program is automatically erased. The circuit must be switched off manually or wait for the 12 hour automatic shut off. If you wish to override the 12 hour default shut-off time you can extend the time by using the “Egg Timer” countdown feature (page 30).

Note: The following example describes how use the “Once Only” feature to program the spa circuit to switch the filter pump on and rotate the valves into the “Spa” position and switch the heater on for one time only. This example can also be used if you wanted to program when to filter and heat your pool, and switch light or auxiliary circuits on.

The set a “Once Only Timer” program for the spa:

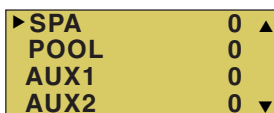
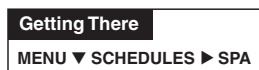

Right button: Select the **Spa** circuit. The generic circuit names are: Spa, Pool, Aux 1-7, Feature Circuit 1-8, and Aux Extra. Aux Extra is only available if the Solar output (J17) plug on the EasyTouch motherboard is not being used for solar equipment. Use the Solar button to switch the “extra” auxiliary circuit on and off (see page 5).

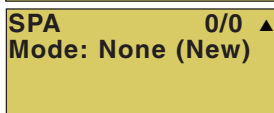

Right button: Select **Mode** if there are existing programs. Skip this step to create a new program.

Up/Down button: Select **New** to create a new program.

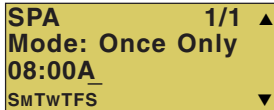

Right button: To create a new program and enter the “Mode” settings.

Up/Down button: 1/1 indicates that this circuit has one program. If there are existing programs assigned to this circuit, use these buttons to view and select the existing program settings.

Right button: To select the “Once Only” settings.

Right button: Select start time settings.

Up/Down and Right buttons: Set the start hour (A/P) and minutes. A (AM) and P (PM) time is set when setting the start hour. Note: if the Start Time is set to an hour which has already passed, then the program will be executed the following day. Another day of the week may also be chosen. The stop time will be 12 hours later, or can be turned off manually. The 12-hour shut off can be changed to any length of time by entering another program using the “Egg Timer” program (page 30).

Right button: Select the day of the week to run the program.

Right button: Select which day to run the program then press the **Up/Down button** to enable the bar on top of the letter. A bar on top of the letter indicates the day selected to run the program.

Press the **Menu** button to save the settings and to return to the Schedules menu options. Press the button again to return to the main menu options or press again to return to the main screen.

Using the Egg Timer (countdown) Feature

The “Egg Timer” feature allows you switch off a circuit automatically after a specified time. The time period is from one minute to 24 hours or run continuously. The “Egg Timer” (countdown) feature is useful for switching off lighting and spa therapy jets. For example, a jet pump can be setup to switch off in 15 minutes, even if you switch it on using the iS4 or iS10 Spa-Side remote control or whenever you switch your spa on, you would like it to automatically switch it off in two hours. All Egg Timer programs are factory set to switch off after 12 hours. You also have the option to use the “Don’t Stop” feature to run a circuit continuously until manually switched off.

In the event of a power failure, the “Egg Timer” feature will not switch the circuit back on. Use the “Service” mode to turn the equipment back on. Refer to “Mode button,” page 4 for more information. For running the filter pump continuously during new pool start up, it is recommended to use the “Service” mode, which will automatically restart the filter pump in the event of a power failure.

The following example describes how use the “Once Only” feature to program the spa circuit to switch the filter pump on and rotate the valves into the “Spa” position and switch the heater on for one time only. This example can also be used if you wanted to program when to filter and heat your pool, and switch light or auxiliary circuits on.

To set the Egg Timer feature:

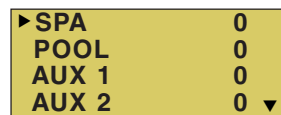

Right button: Select the **Spa** circuit. The generic circuit names are: Spa, Pool, Aux 1-7, Feature Circuit 1-8 and Aux Extra. Aux Extra is only available if the Solar output (J17) plug on the EasyTouch motherboard is not being used for solar equipment. Use the Solar button to switch the “extra” auxiliary circuit on and off (see page 5).

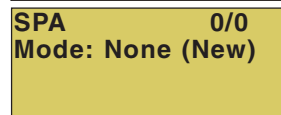

Right button: Select **Mode** if there are existing programs. Skip this step to create a new program.

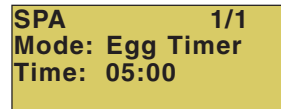

Up/Down button: Select **New** to create a new program.

Right button: To create a new program and enter the “Mode” settings.

Up/Down button: 1/1 indicates that this circuit has one program. If there are existing programs assigned to this circuit, use these buttons to view and select the existing program settings.

Right button: To select the “Egg Timer” settings.

Right button: Select the time settings.

Up/Down and Right buttons: Set the hour and minutes for the program to run. The count down time can be set from 00:01 to 23:59 and Don’t Stop. The “Don’t Stop” feature allows the circuit to run continuously until manually switched off.

Press the **Menu** button to save the settings and to return to the Schedules menu options. Press the button again to return to the main menu options or press again to return to the main screen.

Settings Menu: Clock

Use the Clock menu to set the EasyTouch system date and time. The day, time and AM/PM is displayed on the main screen. The system clock settings are used for the EasyTouch system scheduled operations. The EasyTouch system clock will continue to run if power is removed from the EasyTouch system at the load center.



Clock

To set the system date and time:

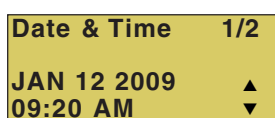

Right button: Select day setting.

Up/Down buttons: Set the day of the month.

Right button: Select year setting.

Up/Down buttons: Set the year.

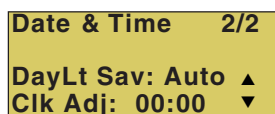

Right button: Select the next set of settings (2/2).

Up/Down buttons: Set Daylight Savings to Auto or Manual. Auto keep track of the semi annual time changes. If you do not live in an area that observes daylight savings time, choose Manual.

Right button: Select the clock adjustment setting. If the internal system clock loses time during the month, use this setting to set the number of seconds in five second increments per month to automatically adjust the clock to the correct time.

Up/Down buttons: Adjust the offset in five second increments.

Press the **Menu** button to save the settings and to return to the Settings menu options. Press the button again to return to the main menu options or press again to return to the main screen.

Settings Menu: IntelliFlo® (or IntelliPro® pump)

The EasyTouch system communicates with the IntelliFlo pump via a two-wire RS-485 cable (PN 350122). For more information about the IntelliFlo pump see the IntelliFlo VS Installation and User's Guide (P/N 357269), for the IntelliFlo VF pump, see the IntelliFlo VF Installation and User's Guide (P/N 350075). From the IntelliFlo menu setting the following pumps can be programmed to run at specific U.S. gallons per minute (GPM) or speed (RPM):

- The IntelliFlo VF (15-130 GPM) and IntelliPro® VF (15-130 GPM) pump.
- The IntelliFlo VS+ SVRS (1100-3450 RPM), IntelliFlo VS3050 (400-3110 RPM) and IntelliPro VS3050 (400-3450 RPM) pump.

How many IntelliFlo pumps will EasyTouch support?

EasyTouch can support a total of two IntelliFlo (or IntelliPro) VF or IntelliFlo VS pumps in any combination with up to eight GPMs or RPMs per pump. For example pumps can be connected to EasyTouch as follows:

- 1 IntelliFlo VF + 1 IntelliFlo VS
- 2 IntelliFlo VF
- 2 IntelliFlo VS

IntelliFlo® VS pump

To access the IntelliFlo or IntelliPro VS menu:

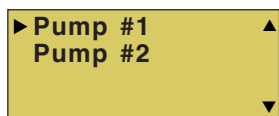

Up or Down button: Choose **Pump #1** or **Pump #2**.

Right button: Select **Pump #1** to assign as **IntelliFlo VF** or **IntelliFlo VS**.

Right button: Select **Pump Type**.

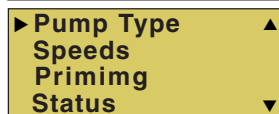

Up/Down buttons: Select **VS** (IntelliFlo VS).

Menu button: Press the menu button to save selection and go to the IntelliFlo VS menu settings.

Down button: Choose **Speeds**.

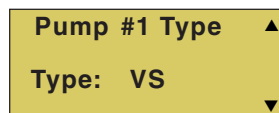

Right button: Access the IntelliFlo VS settings for **Pump #1**.

Up/Down button: Select the circuit number 1 of 8 (1/8). The default speed for each circuit correspond to the four speed buttons on the IntelliFlo VS control panel. The preset speed for each button is: Speed 1 button 750 RPM, Speed 2 button 1500 RPM, Speed 3 button 2350 RPM, and Speed 4 button 3110 RPM.

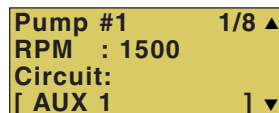

Right button: Select RPM to change the pump speed.

Up/Down buttons: Set speed of the pump from 400 to 3110 RPM in increments of 10 RPM (For the IntelliFlo VS), 400-3450 RPM (IntelliPro VS).

iS4/iS10 pump speed control: IntelliFlo pump speed can be increased or decreased in increments from an iS4 or iS10 spa-side remote. See "iSx Pump Control" in the "Settings" menu (page 46).

Press the Right button to view the circuit names.

Press the Up/Down buttons to assign the circuit: None, Spa, Pool, Aux 1-7, Feature 1-8, Aux Extra (only if Solar is not selected, see page 25 and 42), Heater, Pool Heater, Spa Heater, Freeze, Pool/Spa, Solar/Heat. "Aux Extra" is only available if the Solar output (J17) plug on the EasyTouch motherboard is not being used for solar equipment.

Right button: Press the Up arrow button and go to the next circuit page settings (2/8) and repeat the previous steps.

When finished setting up the circuits, press the **Menu** button to save the settings and to return to the Settings menu options. Press the button two times to return to the main screen.

IntelliFlo VF pump

To access the IntelliFlo VF menu:

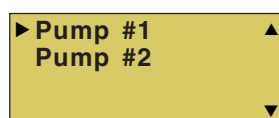

Up or Down button: Choose **Pump #1** or **Pump #2**

Right button: Select **Pump #1** to assign as **IntelliFlo VF** or **IntelliFlo VS**.

Right button: Select **Pump Type**.

Up/Down buttons: Choose **Select VF** (IntelliFlo VF).

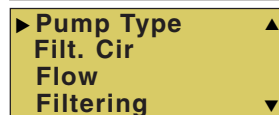

Menu button: Press the menu button to save selection and go to the IntelliFlo VS menu settings.

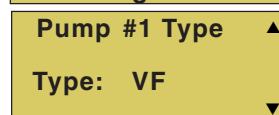

Press the Down button: Choose **FILT. CIRCUIT**. Press the **Right button** to access the filter circuits settings. **Press the Up/Down buttons** to assign the circuit:

None, Spa, Pool, Aux 1-7, Feature 1-8, Aux Extra (only if Solar is not selected, see page 25 and 42), Heater, Pool Heater, Spa Heater, Freeze,

Pool/Spa, Solar/Heat. “Aux Extra” is only available if the Solar output (J17) plug on the EasyTouch motherboard is not being used for solar equipment. Press the **MENU button** to save and exit to Pump menus.

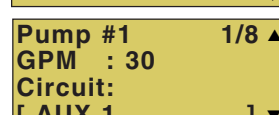

Press Down/Up button to select FLOWS. **Press the Right button to access settings:** **Press the Up/Down buttons** to set GPM and CIRCUIT for circuit 1 of 8.

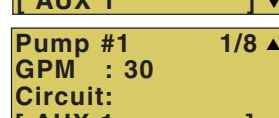

After circuit selection is finished, press the **Up arrow button** and go to the next circuit page settings (2/8) and repeat setup. Up to eight (8) circuits can be assigned.



When finished, Press the **MENU button** to save and exit to Pump menus.

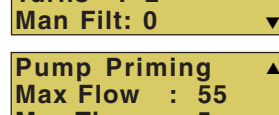

Press Down/Up button to select FILTERING, PRIMING, BACKWASH, VACUUM, or STATUS. **Press the Right button to access settings:** **Press the Up/Down buttons** to set parameters. See IntelliFlo VF parameter descriptions

below:

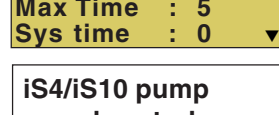

Filtering -Pool Size/Gallons: 0 - 255 (Kgals) - **Turnovers per day:** (1 - 8)

Filtering Manual Filter GPM: (15 - 130) Default 30 GPM: Manual Filter sets the flow at which the pump will run if it is turned on manually. The IntelliFlo pump will only run in the 'Filter' mode during the programmed times. For example, if the pump is programmed (start/stop times) for the pool circuit to run from 8:00 AM to 4:00 PM everyday. This program or programs are used by IntelliFlo to calculate at what speed it must run given those 'ON' times to achieve the turnover(s) for that sized pool for the basic filter mode.

Priming - Max Prime Flow GPM: (15 - 130) Default 55 GPM: Every time the pump starts this parameter will negotiate the maximum flow of the pump. If the flow is too high, equipment damage can occur. If the flow is too low the pump will not prime. This “flow” is system dependent and may require adjustment. The pump will never flow more than this parameter is set to, however, it is common for the pump to ramp up and down quickly while priming. Always try to keep this flow as low as possible for cost savings and safety.

Priming - Max Prime Time: (1 - 15 minutes) Default 15 min.: Use this parameter to set the time that you want IntelliFlo try and prime before it reports an error. Remember that the IntelliFlo will attain prime every time it starts and goes through this cycle. The IntelliFlo mechanical seal can withstand about 15 minutes before severe damage occurs. The lower the time the quicker you will get a priming error if the system is difficult to prime. A well plumbed pool without having the strainer removed should prime in less than 30 seconds. If the strainer has been removed for cleaning and a substantial amount of air is in the system it should prime in about 60 to 90 seconds on the average, however, all systems will be different.

Priming - System Prime Time: (0 - 5 minutes) Default 0 min.: Remember that the average unit will prime in a short period of time because the IntelliFlo has the ability to monitor itself to make sure it is primed. “System Prime Time” is for systems that require high flows that priming flow can provide but it is deemed that more time is needed to fully relieve all the air. The builder can program a pre determined amount of time, up to 5 minutes, to aid in relieving the air from difficult filters or complex vertical plumbing. The “System PrimeTime” should only be used where large air traps become problems within the system. The display will inform the user when this is engaged and when it is finished during the priming cycle at each start up cycle.

iS4/iS10 pump

speed control:

IntelliFlo pump speed can be increased or decreased in increments from an iS4 or iS10 spa-side remote. See “iSx Pump Control” in the “Settings” menu (page 46).

IntelliFloVF parameters (Continued)

Backwash	▲
Clean Filt : 10	
Flow GPM : 60	
Duration : 5	▼

Clean Filter PSI (1 - 50 psi) Default 14 PSI

The average PSI setting is between 10 PSI and 20 PSI for most pools and filters. The entered PSI value splits the percentage meter for the filter. When the "clean filter" value is reached, EasyTouch displays an alert message and the pump stops monitoring flow rates and starts managing pressure. The value represents the change in pressure over time from start up (system clean) to present day (system getting dirty). The changes can come from anywhere in the system, for example clogged skimmers or pots in pumps. Setting this parameter at a lower level will cause the alert message to come up sooner and you will have to clean your filter (cartridge) or backwash your filter (sand or DE) sooner.

Backwash Flow GPM (15 - 130 GPM) Default 60 GPM.

Backwash Duration (1-60 minutes) Default 5 minutes.

Rinse Time (1-60 minutes) Default 1 minute.

Pump Vacuum	▲
Flow (gpm) : 50	
Time (min) : 10	▼

Vacuum Flow GPM (15-130 GPM) Default 50 GPM

This setting sets the GPM that the pool vacuum will use.

Vacuum Time Mins. (1 - 600 minutes (10 hours) Default 10 minutes

This parameter can be set from 1 to 600 minutes. The typical setting is 10 minutes. This setting sets the amount of time you wish to run the pool vacuum.

GPM: 73	▲
1927 RPM 1980 W	
Filter: 7	
Status: NORMAL	▼

Status screen: Displays current operating information: GPM, RPM, Filter minutes, and pump communication status.

Settings Menu: IntelliChlor

While the EasyTouch system is in normal operating mode (“Pool,” “Spa” mode or “Spa Fill (Spillway),” it will control the IntelliChlor chlorine output level. The amount of chlorine introduced into the pool is determined by the amount of salt in the water, water temperature, and the amount of time the pool pump is running in “Pool” mode. Note: While in “Freeze Protection” mode, IntelliChlor will not operate or produce chlorine during the time that the filter pump is operating. For more information, refer to the IntelliChlor Electronic Chlorine Generator User’s Guide (P/N 520589).

IntelliChlor



To setup the IntelliChlor :

IntelliChlor	1/2▲
Enable: No	
Level: 50%	▼
IntelliChlor	2/2▲
Super Chlr: Off	
Run Hours: 24	▼

Right button: Enable/Disable IntelliChlor. (To select SuperChlor, run hours, press the Up/Down button - 2/2).

Up/Down buttons: Select **Yes** or **No** to enable or disable IntelliChlor.

Right button: POOL Mode “50%” setting.

Up/Down buttons: Set the chlorination output level for the pool water from 0 to 100%. EasyTouch will determine the chlorinator output level when the system is operating in “Spa” or “Pool” mode. The amount of chlorine introduced into the pool/sap is determined by the amount of salt in the water, water temperature, and the amount of time the pool/spa operates in these modes mode.

Right button: SPA Mode “0%” setting.

Up/Down buttons: Set the chlorination output level for the spa water from 0 to 20%. To prevent over chlorination of the spa, the EasyTouch system will automatically drop the chlorine output levels to 1/20th of the current pool output when the spa is switched on. For example, if the pool output level is set to 60%, when the spa is switched on, the chlorination level is reduced to 3%.

Right button: Select the next set of settings (2/2).

Up/Down buttons: Select 2/2.

Right button: Move the Super Chlorination settings.

Up/Down buttons: Set Super Chlorination **On** or **Off**. See note below about Super Chlorination.

Right button: Select “Run Hours” setting.

Up/Down buttons: Set the number of hours to run Super Chlorination. 24 hours is the default setting. Run hours can be set from 0 to 72 hours.

Press the **Menu** button to save the settings and to return to the Settings menu options. Press the button again to return to the main menu options or press again to return to the main screen.

Note: For IntelliChlor status messages, see “Diagnostics: Chlorinator” page 53.

About Super Chlorination: The Super Chlorination feature is used to introduce large amounts of chlorine into the pool water if there has been heavy rain fall, many bathers in the pool, cloudy water conditions, etc. When Super Chlorination is enabled, the system will switch on the filter pump, set the pool/spa valves to the correct position, and set the IntelliChlor chlorine generator to maximum output. This process continues for 24 hours. At the end of the Super Chlorination process, the pool will return to normal operation. It is possible to manually stop the Super Chlorination process and switch off the filter pump using the Filter (F) button on the main control panel at the pool equipment pad. When the filter pump is switched on again using the Filter (F) button, the Super Chlorine process will resume for the duration of time left.

Settings Menu: ThermalFlo® Heat Pump

ThermalFlo screen

From the ThermalFlo® heat pump screen you can view the current ThermalFlo operation status, and set the unit to operate with for heating only, cooling only, or both heating and cooling if the unit is reversible. Connection from ThermalFlo is via the COM PORT on the EasyTouch motherboard. See page 63 for ThermalFlo to EasyTouch COM port wiring information. The ThermalFlo must be set to default ADDRESS 1. One ThermalFlo unit can be connected to EasyTouch.

*Note: Once the ThermalFlo is enabled, use the **Left** and **Right** arrow buttons to adjust the ThermalFlo temperature and cooling, (see page 3).*

ThermalFlo

To access ThermalFlo settings menu:

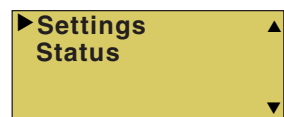

Right button: Access the “Settings” menu.

Up/Down buttons: Select **Yes** or **No** to enable or disable ThermalFlo.

Right button: Select the “Heating” setting.

Up/Down buttons: Select **Yes** or **No** to use for heating.

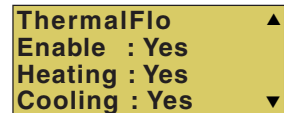

Right button: Select the “Cooling” setting.

Up/Down buttons: Select **Yes** or **No** to use for cooling only or if the unit is reversible select both heating and cooling.

Press the **Menu** button to save the settings and to return to the ThermalFlo Settings and Status menu options.

Press the **Menu** button three times to return to the main screen.

To access ThermalFlo Status menu:

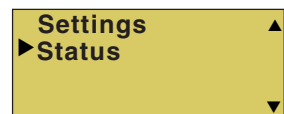

Right button: Access the “Status” menu.

Press the **Menu** button to return to the main screen.

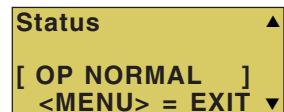

Settings Menu: Circuit Names

Labeling Circuit Buttons in the EasyTouch Load Center

EasyTouch is factory configured to display each output circuit by its generic name (e.g. AUX 1, AUX 2, etc.). These generic circuit auxiliary names can be assigned a new names which are more descriptive of the equipment being controlled. This makes it much easier to operate all of the pool, spa and lighting equipment without having to memorize what each output controls.

For circuit identification, adhesive backed circuit name labels are provided for placement next to each auxiliary control panel button. Use the written list of circuit names (buttons) that you made while setting up the EasyTouch system load center. Identify what you labeled circuit button 1, button 2 etc. The circuit names you assign should match the labels you put on the EasyTouch load center control panel buttons and/or the optional Indoor Control Panel buttons. Note that examples shown below use the factory set generic output names displayed in the EasyTouch control panel menus.

Circuit Names

To assign circuit names:

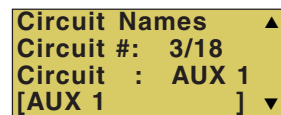

Up/Down buttons: Select the circuit number 1/18. Press the **Up button** two times to select AUX 1. The generic circuits names are: Spa (1/18), Pool (2/18), Aux 1-7, Ft 1. (10/18) - Ft. 8 (17/18), AuxX (18/18 - Aux Extra). The circuit number 1/18 corresponds to its assigned circuit name. This name can be changed to suite the function. Aux Extra is only available if the Solar output (J17) plug on the EasyTouch motherboard is not being used for solar equipment. Use the Solar button to switch the “extra” auxiliary circuit on and off (see page 5).

Right button: Select to EasyTouch preset circuit names and user defined custom circuit names.

Up/Down buttons: Scroll through the list of alphabetical programmed names. If you cannot find a name to match your circuit, you can create your own custom name (see page 41). Repeat for all the circuit buttons that you wish to assign names to. For a complete list of EasyTouch circuit names, see page 38.

Press the **Menu** button to save the settings and to return to the Settings menu options. Press the button again to return to the main menu options or press again to return to the main screen.

Note: After a generic circuit name is changed and saved, the new name is displayed in the menu settings. You can view the default generic circuit names in the menu settings before they were changed by enabling “Cir Names.” Refer to “Diagnostics: Cir Names (Off),” on page 54.

Hi-Temp/Lo-Temp Controls for Single Body System

For an EasyTouch single body system, you have the option to control your pool and spa temperature settings using the Valves (V) button or the Spa (Hi-Temp) and Pool (Lo-Temp) button on the optional Indoor control Panel. Change the circuit name **SPA** to **HI-TEMP** and **POOL** to **LO-TEMP** so that the display shows the correct temperature controls for your single body system.

EasyTouch Circuit Names

AERATOR	MALIBU LTS
AIR BLOWER	MIST
AUX 1	MUSIC
AUX 2	NOT USED
AUX 3	OZONATOR
AUX 4	PATH LIGHTS
AUX 5	PATIO LTS
AUX 6	PERIMETER L
AUX 7	PG2000
AUX 8	POND LIGHT
AUX 9	POOL PUMP
AUX 10	POOL
AUX EXTRA	POOL HIGH
BACKWASH	POOL LIGHT
BACK LIGHT	POOL LOW
BBQ LIGHT	POOL SAM
BEACH LIGHT	POOL SAM 1
BOOSTER PUMP	POOL SAM 2
BUG LIGHT	POOL SAM 3
CABANA LTS	SECURITY LT
CHEM. FEEDER	SLIDE
CHLORINATOR	SOLAR
CLEANER	SPA
COLOR WHEEL	SPA HIGH
DECK LIGHT	SPA LIGHT
DRAIN LINE	SPA LOW
DRIVE LIGHT	SPA SAL
EDGE PUMP	SPA SAM
ENTRY LIGHT	SPA WTRFLL
FAN	SPILLWAY
FIBER OPTIC	SPRINKLERS
FIBER WORKS	STREAM
FILL LINE	STATUE LT
FLOOR CLNR	SWIM JETS
FOGGER	WTR FEATURE
FOUNTAIN	WTR FEAT LT
FOUNTAIN 1	WATERFALL
FOUNTAIN 2	WATERFALL 1
FOUNTAIN 3	WATERFALL 2
FOUNTAINS	WATERFALL 3
FRONT LIGHT	WHIRLPOOL
GARDEN LTS	WTRFL LGHT
GAZEBO LTS	YARD LIGHT
HIGH SPEED	FEATURE 1
HI-TEMP	FEATURE 2
HOUSE LIGHT	FEATURE 3
JETS	FEATURE 4
LIGHTS	FEATURE 5
LOW SPEED	FEATURE 6
LO-TEMP	FEATURE 7
	FEATURE 8

Custom Circuit Names (11 characters maximum)

USERNAME-01	_____
USERNAME-02	_____
USERNAME-03	_____
USERNAME-04	_____
USERNAME-05	_____
USERNAME-06	_____
USERNAME-07	_____
USERNAME-08	_____
USERNAME-09	_____
USERNAME-10	_____

Settings Menu: Circuit Functions

Assigning Circuit Functions

From the “Circuit Functions” menu you can assign special logic to the cleaner pump, spa spillway, lights and MagicStream® laminar circuits. For example, when setting up an automatic pool cleaner pump, you would assign the circuit function “MASTER CLEANER.” With this "Cleaner" logic the cleaner pump would force the filter pump on, and the cleaner pump would start after a delay of five minutes. The cleaner pump would automatically shut off whenever the spa and/or solar is switched on.

Freeze Protection

Freeze protection switches on a circuit if the outside air temperature sensor detects the temperature is getting close to freezing (below 35° F). The system will switch on all circuits that have been assigned freeze protection, and runs the circuits for 15 minutes to stop the pipes from freezing. This is especially important if there is a pool and spa combination. If freeze protection is set to both the spa and pool circuits, the filter pump switches on and the pool and spa valves alternate every 15 minutes to keep the water moving in both the pool and spa. This process continues until the freeze condition is over.

Circuit Functions

Getting There

MENU ▼ SETTINGS ▼ CIRCUIT Func. ► CIRCUIT/ Func.

To assign a circuit function and freeze protection:

Circuit/Fun.	▲
[SPA]
[Master Spa]
Freeze: Yes/No	▼

Up/Down buttons: Choose the circuit name (displayed on the second line). The generic circuits names are: Spa [Master Spa - Freeze protection on by default], Pool [Master Pool - Freeze protection on by default], Aux 1-7, Feature 1-8 and Aux Extra. Aux Extra is only available if the Solar output (J17) plug on the EasyTouch motherboard is not being used for solar equipment. Use the Solar button to switch the “extra” auxiliary circuit on and off (see page 5).

Right button: Select the “Circuit Function” setting to select the circuit function for the select circuit name displayed on the line above.

Up/Down buttons: Select the circuit function. This is the circuit that you wish to assign the function logic to. For a complete list of preset circuit functions, see “Preset Circuit Functions,” on page 40.

Right button: Select Freeze Protection.

Up/Down buttons: Select **Yes** or **No** to assign freeze protection to this circuit. If “Yes” is selected, the circuit will switch on if the air temperature drops to 35° F.

Note: for the POOL circuit the filter pump will have freeze protection. For the SPA circuit the filter pump will run and the pool/spa valves will switch between pool and spa at 15 minutes intervals throughout the freeze condition. For the MASTER CLEANER circuit freeze protection is generally not needed for pool cleaner pumps since they get water flow from the filter pump. Just make sure that POOL has freeze protection.

Press the **Menu** button to save the settings and to return to the Settings menu options. Press the button again to return to the main menu options or press again to return to the main screen.

Preset Circuit Functions

Generic	No special Logic. Simple On/Off control of a circuit with all the programmable capabilities.
Master Spa	Works with automatic pool cleaner pumps or cleaner valve actuator. It does the following: <ul style="list-style-type: none"> - Forces the filter pump on 5 minutes before the cleaner pump switches on. - Switch the cleaner off when the spa is on. - Switch the cleaner off for 5 minutes when the solar heating begins.
Master Pool	Works with automatic pool cleaner pumps or cleaner valve actuator. It does the following: <ul style="list-style-type: none"> - Forces the filter pump on 5 minutes before the cleaner pump switches on. - Switch the cleaner off when the spa is on. - Switch the cleaner off for 5 minutes when the solar heating begins.
Master Cleaner	Works with automatic pool cleaner pumps or cleaner valve actuator. It does the following: <ul style="list-style-type: none"> - Forces the filter pump on 5 minutes before the cleaner pump switches on. - Switch the cleaner off when the spa is on. - Switch the cleaner off for 5 minutes when the solar heating begins.
Light	Allows special lighting features to work, such as ALL lights on or ALL lights off.
SAM Light	Activates special color lighting programs on other screens on the Indoor Control Panel when used with SAM pool lights. For example, you can have ALL lights on or ALL lights off.
SAL Light	Activates special color lighting programs on other screens on the Indoor Control Panel when used with SAL spa lights. For example, you can have ALL lights on or ALL lights off.
Photon Generator	Photon Generator® light source allows Pentair Fiberworks fiber optic bulb be operated by the Lights menu features Sync, Rotate, ALL ON and ALL OFF when used with SAM and SAL lighting.
Color Wheel	Activates special color lighting programs on other screens on the Indoor Control Panel when used with Pentair Fiberworks. For example, you can have ALL lights on or ALL lights off.
Spillway	For pool/spa combinations where the spa is raised above the pool. This setting moves the return valve so that the filter pump pulls the water from the pool and returns it to the spa, creating a water fall effect. Automatic pool cleaners are turned off when this feature is turned on.
Floor Cleaner	This setting moves a 3-way valve every 20 minutes alternating flow between 2 cleaner system valves that feed the pop-up heads.
IntelliBrite	Activate an Intellibrite LED light.
MagicStream	Activate a MagicStream laminar.

Settings Menu: Custom Names

There are nearly 100 circuit names available to choose from. If you cannot find one to fit your application you can create up to 10 custom names. Each name can be up to 11 alphanumeric characters. After a custom name is saved, it is then available for selection in the Schedules, 2-Speed Pump, iS4 and QuickTouch menus.



Custom Name

To assign a custom circuit name:

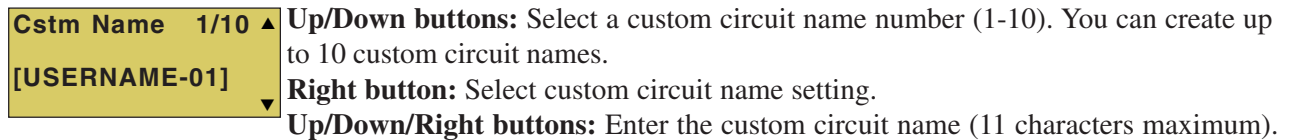

Press the **Menu** button to save the settings and to return to the Settings menu options. Press the button again to return to the main menu options or press again to return to the main screen.

Settings Menu: Valves

This feature lets you assign a circuit to Valve A or B. The EasyTouch system can drive two auxiliary valve actuators (A and B) for applications such as solar heating and water features. By assigning AUX circuits to control valve actuators, you can conserve auxiliary circuits for high voltage relays for controlling pumps and lights.

Valve A: Resides on the EasyTouch motherboard. If solar heating is setup and is not configured as a heat pump, then Valve A is dedicated for controlling the solar heating valve actuator. Solar is enabled in the “Solar” menu. The Valve A selection will display “USED SOLAR.”

Valve B: Resides on the EasyTouch motherboard. Can be configured to be controlled by any circuit.



Valves

To assign a circuit to Valve A and Valve B:

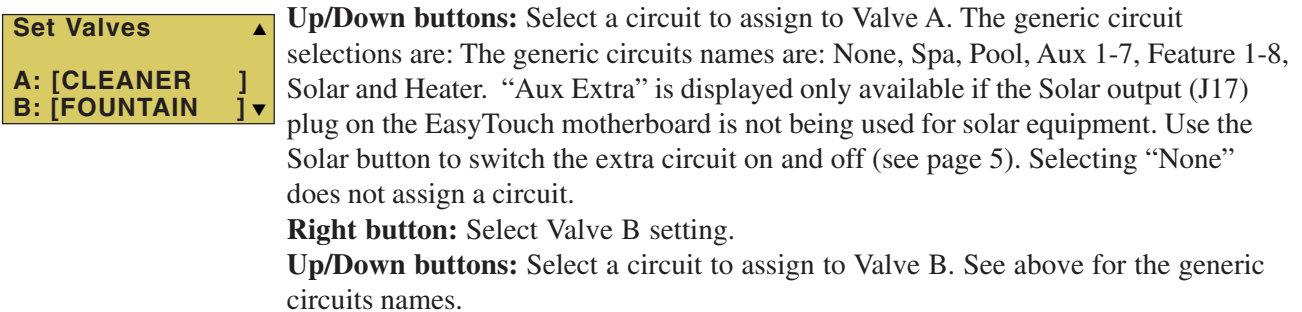

Press the **Menu** button to save the settings and to return to the Settings menu options. Press the button again to return to the main menu options or press again to return to the main screen.

Settings Menu: 2-Speed Pump

Equipment circuits selected in this menu will automatically switch a two-speed filter pump to high speed when these circuits are on. If a two-speed pump is assigned to solar, a cleaner or a pump, when activated the pump will automatically run for five minutes in high speed then switch to low speed. For example, when on, the filter pump will switch to high speed whenever the JETS or CLEANER is on. There must be a two-speed relay installed in the EasyTouch Load Center in order for the “2-Speed Pump” menu settings to function.

2-Speed Pump



To configure a two-speed pump to a circuit:

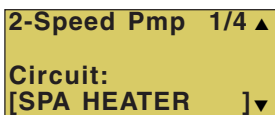

Up/Down buttons: Select a circuit that will switch the filter pump to high speed. You can set up to four circuits to use a two-speed pump (1/4, 2/4, 3/4, 4/4).

Right button: Assign a circuit setting.

Up/Down buttons: Select the circuit to assign to a two-speed pump. The generic circuits names are: None, Spa, Pool, Aux 1-7, Feature 1-8, Solar, Heater, Pool Heater, Spa Heater and Freeze. “Aux Extra” is displayed only available if the Solar output (J17) plug on the EasyTouch motherboard is not being used for solar equipment. Use the Solar button to switch the extra circuit on and off (see page 5). Selecting “None” does not assign a circuit. *Note: You can use a Feature circuit to change a 2-Speed pump to high speed.*

Right button: Assign the next circuit (2/4).

Up/Down buttons: Select the first digit for the circuit number (1/4, 2/4, 3/4, 4/4).

Right button: Select circuit setting.

Up/Down buttons: Select the next circuit. When finished press the **Menu** button. Press the **Menu** button to save the settings and to return to the Settings menu options. Press the button again to return to the main menu options or press again to return to the main screen.

Settings Menu: Solar

Use the solar settings to setup solar or configure solar as a heat pump:

Setting Up Solar Control: Ensure that the solar temperature sensor is installed.

About Installing Solar Heating: First, install the solar sensor at the collectors and connect to the EasyTouch load center. If “HEAT PUMP” is selected and is being used in place of a solar heating system, install Solar sensor near the EasyTouch Load Center. Connect the wires to the SOLAR screw terminals according to the wiring diagram on page 60. Plug the solar valve actuator cable into three-pin socket marked VLV A on the EasyTouch motherboard. If a solar booster pump is being installed, connect the pump to a power relay and plug a low voltage cable from relay into the two-pin socket marked SOLAR on the EasyTouch motherboard.

Note: If Solar is not selected (No), the EasyTouch menu selections display “AUX EXTRA” instead of “SOLAR.” This allows the solar plug (J17) on the EasyTouch motherboard to be used as an “extra” auxiliary output circuit. The Solar button is used to switch on and off the extra auxiliary circuit.

To access the Solar menu:



Solar

To enable a solar heater and set the temperature start and run time settings:

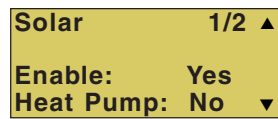

Up/Down buttons: Select **Yes** or **No** to enable solar (1/2). In order to display the solar selection as a heat source in the main screen, select **Yes**.

Right button: Select the Heat Pump setting.

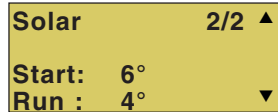

Up/Down buttons: Select **Yes** or **No** to enable solar as a heat pump. **Heat Pump Control instead of Solar:** Select **Yes** if a heat pump is being used in place of a solar heating system. If Solar is set to heat pump, Valve A is free for other circuits.

Right button: Select 2 of 4 (2/4) to access the solar temperature differential start up and run settings.

Up/Down buttons:

Start: Set the temperature differential to start heating from 3° to 9°. For example, if “Start” is set to 3°, this ensures that the temperature has to deviate by 3° at least to the specified set point temperature (in the Heat menu, on page 25) before it switches on. Once the solar comes on it will start converging as it is heating. This ensures that it will not continually be switching on and off.

Run: Set the temperature differential to stop heating from 2° to 5°. This setting sets how close to the target set point temperature to switch off solar heat.

Press the **Menu** button to save the settings and to return to the Settings menu options. Press the button again to return to the main menu options or press again to return to the main screen.

Settings Menu: Delays

Setup which functions (pool/spa, and valves) to assign the delay feature. Delays can be assigned to the following equipment.

- **Heater Cool-Down Delay Cancel:** Shuts Filter Pump off immediately.
- **2-Speed Filter Pump five-minute START on HIGH SPEED Delay Cancel:** Shifts pump to low speed.
- **Automatic Pool Cleaner START Delay:** Starts Cleaner Pump immediately, without normal delay in which the filter pump first runs for 5 minutes.
- **Automatic Pool Cleaner SOLAR Delay:** Allows Cleaner Pump to run even though solar delay has shut it off for 5 minutes.

Some heaters require a cooldown cycle before being switched off. This can be setup to run the filter pump an additional ten minutes to dissipate residual heat built up inside the heater combustion chamber. You can also cancel the delay feature. For information about using the cancel delay feature, refer to “Delay Cancel” on page 26.



Delays

To assign the delay feature:

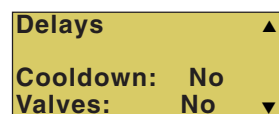

Press the **Up/Down buttons** to select **Yes** or **No** to enable or disable delays for the pool and spa circuits (“Cooldown”). Press the **Right button** to select the valves setting. Press the **Down buttons** to select **Yes** or **No** to enable or disable delays for valves. Press the **Menu** button to save and to return to the Settings menu options. Press the **Menu** button again to return to the main menu or press again to go to the main screen.

Settings Menu: F° / C° (Fahrenheit/Celsius)

The temperature settings for the water, solar and air can be displayed in either Fahrenheit or Celsius.



F° / C°

To change the temperature units:



Up/Down buttons: Select either Fahrenheit or Celsius. Press the Menu button to save the settings and to return to the Settings menu options. Press the **Menu** button again to return to the main menu options or press again to return to the main screen.

Settings Menu: iS4 Spa-Side Remote Controller

You can specify any iS4 Spa-Side remote button to control different functions by assigning each button to a specific circuit. For example, you can use the iS4 Spa-Side remote to activate the spa circulation and for operating auxiliary equipment such as heater, lights, jet pump, heat boost, air blower, waterfall, etc.). You can also use the “Pump Incrs” and “Pump Decrs” circuit to increase or decrease the pump speed for an IntelliFlo VF (GPM) or VS (RPM) pump. For example, if the “Pump Incrs” circuit is assigned to an iS4 button, each press of the button will increase the pump speed in specific speed increments as specified in the “iSx Pump Cntrl” menu setting (see page 46). Speed increments are set from 10 to 250 RPM (or 1 to 10 GPM, for the IntelliFlo VF).



Assign iS4

Before configuring the iS4 Spa-Side remote controller assign names to the circuits (see page 42).

To assign iS4 Spa-Side buttons:

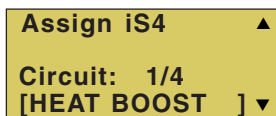

Up/Down buttons: Select a circuit to one of the iS4 buttons. You can set up to four circuits (1/4, 2/4, 3/4, 4/4).

Right button: Select the circuit setting.

Up/Down buttons: To configure the first button on the iS4 Spa-Side Remote, scroll through the circuit names and find the circuit that you would like to assign to the first button on the iS4. The generic circuits selections are: None, Spa, Pool, Aux 1-7, Feature 1-8, Solar (if selected in “Heat” menu), Heat Boost, Heat Enable, Pump Incrs, Pump Decrs. “Aux Extra” is displayed only available if the Solar output (J17) plug on the EasyTouch motherboard is not being used for solar equipment. Use the Solar button to switch the extra circuit on and off (see page 5). Selecting “None” does not assign a circuit.

Note: The “Heat Boost” feature will switch on the heater for seven minutes to increase the spa water temperature. Each time the spa Heat Boost button is pressed, the temperature will increase about 1° F. The temperature will not go beyond the 104° F limit.

Right button: Assign the next circuit (2/4).

Up/Down buttons: Select the first digit for the circuit number (1/4, 2/4, 3/4, 4/4) and repeat the procedure for the other three buttons.

Press the **Menu** button to save the settings and to return to the Settings menu options. Press the button again to return to the main menu options or press again to return to the main screen.

Note: To disable or enable the iS4 Spa-Side remote, see Settings Menu: Spa Side,” on page 51.

Settings Menu: iS10 Spa-Side Remote Controller

You can specify any iS10 Spa-Side remote button to control different functions by assigning each button to a specific circuit. The iS10 has ten assignable circuit buttons; five buttons on the top row and five buttons on the bottom row. You can also use the “Pump Incrs” and “Pump Decrs” circuit to increase or decrease the pump speed for an IntelliFlo VF (GPM) or VS (RPM) pump. For example, if the “Pump Incrs” circuit is assigned to an iS10 button, each press of the button will increase the pump speed in specific speed increments as specified in the “iSx Pump Cntrl” menu setting (see page 46). Speed increments are set from 10 to 250 RPM (or 1 to 10 GPM, for the IntelliFlo VF).

Assign iS10



Before configuring the iS10 Spa-Side remote controller assign names to the circuits (see page 37).

To assign iS10 Spa-Side buttons:



Up/Down buttons: Select the “Top” or Bottom” row to assign circuits to.

Right buttons: Select a circuit to one of the iS10 buttons. Five top row buttons can be assigned circuits (1/5, 2/5, 3/5, 4/5 and 5/5). See “iS10 button assignments” below for details.

Right button: Select the circuit setting.

Up/Down buttons: To configure the first button on the iS10 Spa-Side Remote, scroll through the circuit names and find the circuit that you would like to assign to the first button on the iS4. The generic circuits selections are: None, Spa, Pool, Aux 1-7, Feature 1-8, Solar (if selected in “Heat” menu), Heat Boost, Heat Enable, Pump Incrs, Pump Decrs. “Aux Extra” is displayed only available if the Solar output (J17) plug on the EasyTouch motherboard is not being used for solar equipment. Use the Solar button to switch the extra circuit on and off (see page 5). Selecting “None” does not assign a circuit.

Note: The “Heat Boost” feature will switch on the heater for seven minutes to increase the spa water temperature. Each time the spa Heat Boost button is pressed, the temperature will increase about 1° F. The temperature will not go beyond the 104° F limit.

Right button: Assign the next circuit (2/5).

Up/Down buttons: Select the first digit for the circuit number (1/5, 2/5, 3/5, 4/5) and repeat the procedure for the other three buttons.

Press the **Menu** button to save the settings and to return to the Settings menu options. Press the button twice to return to the main screen.

iS10 button assignments

Button 1	SPA	POOL
	HI-TEMP	LO-TEMP
Button 2	AUX 1	AUX 5
Button 3	AUX 2	AUX 6
Button 4	AUX 3	AUX 7
Button 5	AUX 4	AUX 8

Settings Menu: iSx Pump Cntrl

From this menu setting you can specify the IntelliFlo VS or VF pump speed (RPM, GPM) in step increments, for the assigned iS4 or iS10 button using the “Pump Incrs” or “Pump Decrs” circuit (see page 44 and 45). For example, the “Pump Incrs” and “Pump Decrs” circuit can be assigned to any two iS10 buttons. Each press of the assigned “increase” button will increase the pump speed in specific speed increments, as specified in the “iSx Pump Cntrl” menu setting. Speed increments are set from 10 to 250 RPM or 1 to 10 GPM.

Assign iSx Pump Cntrl

Before configuring the pump step speed, be sure to specify the IntelliFlo pump number and type in the IntelliFlo menu (“Pump #1, Pump #2,” Pump Type), see page 32.

Getting There

MENU ▼ SETTINGS ▼ iSx PUMP CNTRL ► ASSIGN IS10 & 4QT4

To assign a pump step speed:

**Assign iS10 & 4
Pump Controls
Pump Number: 1
Step RPM: 010**

Up/Down buttons: Select the “Pump Number” as specified in the IntelliFlo menu (see page 32).

Right buttons: Select the pump “Step” speed.

Up/Down buttons: Adjust the “Step” pump speed. Settings are:

- IntelliFlo VS, 10 to 250 RPM
- IntelliFlo VF 1 to 10 GPM.

**Assign iS10 & 4
Pump Controls
Pump Number: 1
Step GPM: 001**

Press the **Menu** button to save the settings and to return to the Settings menu options. Press the button twice to return to the main screen.

Settings Menu: QuickTouch (QT4) Wireless Remote

The QuickTouch QT4 wireless remote controller provides switching of up to four circuits. For example, you can use the QT4 wireless remote to activate the spa circulation, and for operating three auxiliary pieces of equipment (such as heat enabled, lights, jet pump, heat boost, air blower, waterfall, etc.).

Each of the four functions on the QT4 wireless controller has an on and an off button. To switch a circuit on or off, press and hold the appropriate button for at least a full second.

The QT4 buttons can be assigned to any available circuit. However, the QT4 has the following preset circuits assigned to the four buttons:

- Spa button activates the spa circuit.
- A button activates **Auxiliary 1** circuit.
- B button activates **Auxiliary 2** circuit.
- C button activates **Auxiliary 3** circuit.

Assign QT4

Getting There

MENU ▼ SETTINGS ▼ QUICKTOUCH ► ASSIGN QT4

To assign circuits to the QuickTouch wireless controller buttons:

Assign QT4 ▲

Circuit: 1/4
[SPA] ▼

Up/Down buttons: Select a circuit to assign to one of the QuickTouch wireless remote buttons. You can set up to four circuits (1/4, 2/4, 3/4, 4/4).

Right button: Select the circuit setting.

Up/Down buttons: To configure the first button (1/4) on the QuickTouch wireless remote. Use these buttons to scroll through the circuit names and find the circuit that you would like to assign to the first button. The generic circuits selections are: None, Spa, Pool, Aux 1-7, Feature 1-8, Aux Extra, Heat Boost and Heat Enable. Selecting “None” does not assign a circuit. “Aux Extra” is only available if the Solar output (J17) plug on the EasyTouch motherboard is not being used for solar equipment. Use the Solar button to switch the “extra” auxiliary circuit on and off (see page 5).

Note: The “Heat Boost” feature will switch on the heater for seven minutes to increase the spa water temperature. Each time the spa Heat Boost button is pressed, the temperature will increase about 1° F. The temperature will not go beyond the 104° F limit.

Right button: Assign the next circuit (2/4).

Up/Down buttons: Select the first digit for the circuit number (1/4, 2/4, 3/4, 4/4), then repeat the procedure for the other three buttons.

Press the **Menu** button to save the settings and to return to the Settings menu options. Press the button again to return to the main menu options or press again to return to the main screen.

Settings Menu: Man Heat (Off/On)

By default manual heat (Man Heat) is set to “On,” which allows your spa to begin to heat whenever it is manually switched on, (by pressing the **Valves (V)** button and **Filter Pump (F)** button on the outdoor control panel or the **Spa** button on the Indoor Control Panel), even if the Heat menu setting is set to “OFF” (see page 25). Your spa will also begin to heat when switched on by the iS4 Spa-Side remote. This feature allows you to program your spa to filter daily with the heater set to off, and then be ready to heat whenever the Spa button is pressed manually.



Man Heat

To enable or disable spa manual heat when switched on manually:

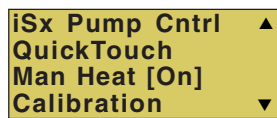

Right button:: Select **Off** to disable or **On** to automatically begin spa heating whenever the spa is switched on manually. Press the **Menu** button to save the settings and to return to the main screen.

Settings Menu: Calibration

The EasyTouch system includes two temperature sensors (10 kΩ) for water and ambient air temperature. You can also add an additional sensor for controlling solar heating systems. Generally, these sensors are accurate and you do not have to calibrate them. However, long plumbing runs and water features can cause temperatures at a body of water to be different from the temperature sensor reading. You can manually recalibrate the sensors to adjust for this. You only need to calibrate one body of water, since the temperature sensor is common to both the pool and spa. The system must be in “Service” mode to calibrate sensors.



Calibration

Before you start, you need an accurate all weather thermometer. If you are calibrating the air sensor, wait until the sensor is not in direct sunlight. For the air temperature sensor, make sure that the sensor is located in the shade for accurate readings.

To calibrate the water, air and solar temperature sensors:

1. Press the **Mode** button on the control panel to place the system in “Service” manual mode.
2. Press the **Filter Pump (F)** button to switch on the pool/spa filter pump.
3. Place the thermometer in the spa or pool water. Take an accurate temperature reading. When calibrating the air sensor, place the thermometer next to the air sensor. The air sensor is normally located near or under the EasyTouch load center enclosure, not inside the enclosure. Take an accurate temperature reading in the shade.
4. Use the **Up** or **Down** buttons to raise or lower the water temperature to match the corresponding thermometer temperature reading.
5. After calibrating the water sensor, use the **Right** button to select the “AIR” setting and repeat step 4 and repeat the procedure for the solar sensor. Ensure that the solar sensor is in the sun for accurate readings.
6. After calibrating all the sensors, press the **Menu** button to save the settings and to return to the Settings menu options. Press the button again to return to the main menu options or press again to return to the main screen.

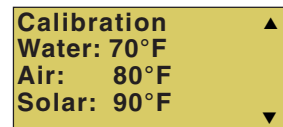

Settings Menu: Erase EEPROM (Erase System Memory)

EasyTouch system configuration data is stored and retained in “Flash” memory in an EEPROM located on the control panel motherboard and optional Indoor Control Panel. The EasyTouch user system configuration data can be erased to restore the factory defaults settings. System information automatically downloads from programmed components to non-programmed components in case of accidental memory loss and to ease board replacement. Any optional controllers (iS4, iS10 or QuickTouch QT4 controller) that were configured need to be reconfigured.

Erase EEPROM

The following procedure describes how to erase the system memory from either the main EasyTouch control panel or the EasyTouch Indoor Control Panel.

CAUTION: This procedure will erase all system settings. Any optional controllers will need to be reconfigured.

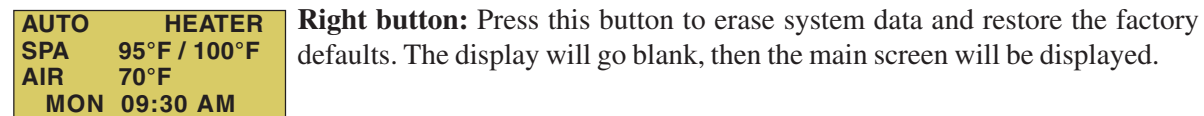
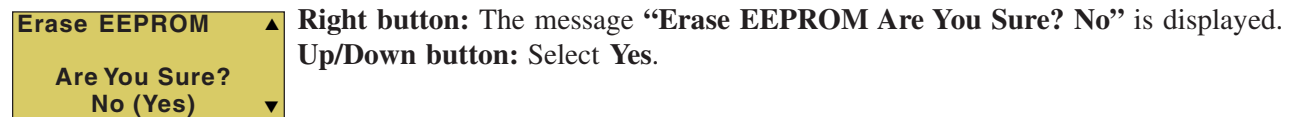
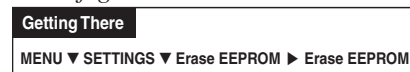

Settings Menu: Set Password

If required, the password feature allows you to password protect the EasyTouch control panel. To access a password protected control panel, you must enter the correct four digit password before access is granted.

Password

To enable the password protect feature:

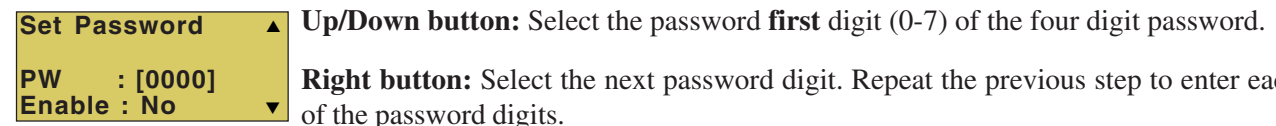

Right button: After you are finished entering the four password digits, press the Right button to enable the password feature.

Up/Down button: Select Yes enable the password feature.

Press the **Menu** button three times to save the settings and to return to the main screen.

Note: If the password feature is enabled, the current four digit password can be viewed from the EasyTouch outdoor control panel in the “Set Password” setting.

Settings Menu: Wireless Addr

Use this feature to configure the EasyTouch wireless control panel with a unique communication address to allow the wireless device to operate with the EasyTouch outdoor control panel (see page 62).

Wireless Addr

Getting There

MENU ▼ SETTINGS ▼ WIRELESS ADDR ► Press Right arrow button

To search and lock on to the EasyTouch wireless control panel:

Address Wireless
Scanning ...

Right button: Press this button to automatically search and lock on to the EasyTouch Wireless Control Panel within range of the EasyTouch transceiver antenna. For more information about the EasyTouch wireless control panel, refer to the EasyTouch Wireless Control Panel User's Guide (P/N 520688).

Address Wireless
Sending Address..

<MENU>

Press the **Menu** button to save the settings and to return to the Settings menu selections.

Spa Side [Off/On]

Enable or disable the iS4 Spa Side remote. This feature is useful for families with young children or when you go on vacation. It allows you to switch off the iS4 Spa Side remote at the control panel so that the remote cannot be used.

Spa Side

To enable or disable the iS4 Spa Side remote:

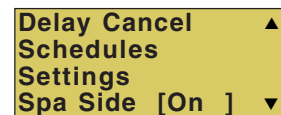
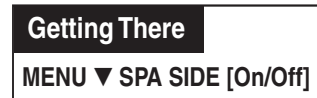

Right button: Select **On** or **Off** to enable or disable the spa side remote. Press the **Menu** button to save the settings and to return to the main screen.

Diagnostics Menu: Software Rev

Displays the current software revision for the EasyTouch main control panel and the optional indoor control panel.

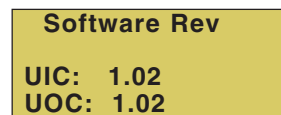

UIC: Displays the current software revision level for the indoor control panel.
UOC: Displays the current software revision level for the outdoor control panel. Press the **Menu** button to return to the Settings menu options. Press the button again to return to the main menu options or press again to return to the main screen.

Diagnostics Menu: Bootloader Rev

Displays the current bootloader revision for the indoor control panel and the main EasyTouch control panel.

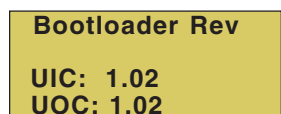

UIC: Displays the current bootloader revision level for the indoor control panel.
UOC: Displays the current bootloader revision level for the outdoor control panel. Press the **Menu** button to return to the Settings menu options. Press the button again to return to the main menu options or press again to return to the main screen.

Diagnostics Menu: Self Test

Tests the control panel LCD and buttons. Follow the on-screen prompts to perform the tests.

Getting There

MENU ▼ DIAGNOSTICS ▼ SELF TEST

Note: If the Indoor Control Panel is connected to the EasyTouch outdoor control panel, select “LINK CLOSED” in the UART test to abort the UART test. This allows the test to complete with and display PASSED.

Firmware Version
Soft: 1.02
Boot: 1.02
Press Any Button

Press the **Right** button to display the current software and boot loader revision levels for the EasyTouch outdoor control panel.

Press the **Right** button to start the test:

Press the Right button to start the test:

Press Any Button



Display Test: Press any button to start the LCD test.

Backlight Test: Press the **Left** then **Right** button.

Backlight On
<=Backlight On
>=Backlight Off

Contrast Test: Press any button to continue.

LED Test: Press any button to continue. All of the button LEDs will be tested.

Contrast:
Press any button

Switch Test: Press any button to continue. As prompted, press the appropriate buttons.

LED Test

UART Test: Select “LINK CLOSED” to abort this test if the optional Indoor Control Panel is connected to the EasyTouch load center.

Switch Test
Press any button

Status: Passed - Code 0: After you have completed the test an error code is displayed. “Passed” is displayed if the test was successful. For error code descriptions, see “Self Test Error Codes,” on page 56.

UART Test
<=Link Closed
>=Link Open

Press the **Menu** button to return to the Settings menu options. Press the button again to return to the main menu options or press again to return to the main screen.

Diagnostics Menu: Chlorinator

Displays the current IntelliChlor chlorination system status. For more information, refer to the IntelliChlor Electronic Chlorine Generator User's Guide (P/N 520589).



Chlorinator ▲
Salt Level:3200ppm
Status:
[OK-NO ERRORS] ▼

Menu: Press this button to return to the Settings menu options. Press the button again to return to the main menu options or press again to return to the main screen.

SALT LEVEL: Displays the current salt level. Values from 0 to 12750 ppm in 50 ppm increments.

IntelliChlor Status messages:

SUPER CHLORINATE: IntelliChlor is in “Super Chlorination mode (see page 35 for details)

COM LINK ERROR: Check cable from IntelliChlor to EasyTouch motherboard.

Check FLOW/PCB: Check IntelliChlor electrolytic cell controller. Refer to IntelliChlor User's Guide troubleshooting information.

LOW SALT: Add salt to pool water. The water salt level is between 2500 ppm and 2900 ppm. The IntelliChlor will continue to produce chlorine at a reduced level.

VERY LOW SALT: Not enough salt in pool. The water salt level has fallen below 2500 parts per million (ppm). IntelliChlor will not produce chlorine until additional salt is added manually.

HIGH CURRENT: Check IntelliChlor electrolytic cell controller. Refer to IntelliChlor User's Guide troubleshooting information..

CLEAN CELL!: Cell has calcium build up and requires cleaning. Refer to IntelliChlor User's Guide for cleaning instructions.

LOW VOLTAGE: Check IntelliChlor electrolytic cell controller. Refer to IntelliChlor User's Guide troubleshooting information.

OK - NO ERRORS: IntelliChlor is in normal operating mode.

Diagnostics Menu: Water Temp

Displays the current water temperature for the pool and spa.



Water Temperature ▲
75° F ▼

Press the **Menu** button to return to the Settings menu options. Press the button again to return to the main menu options or press again to return to the main screen.

Diagnostics Menu: Solar Temp

Displays the current solar temperature.



Solar Temperature ▲
85° F ▼

Press the **Menu** button to return to the Settings menu options. Press the button again to return to the main menu options or press again to return to the main screen.

Diagnostics Menu: Air Temp

Displays the current outside air temperature.

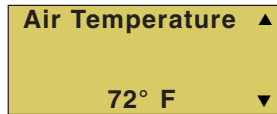

Press the **Menu** button to return to the Settings menu options. Press the button again to return to the main menu options or press again to return to the main screen.

Diagnostics Menu: Cir Name: [Off/On]

This feature is useful if you have renamed many circuits and want to view the original factory default circuit names.

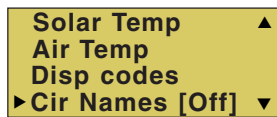

To enable:

Right button: Select **On** to view the factory default circuit names.

Press the **Menu** button to exit.

To disable:

Right button: Select **Off** to disable the feature.

Press the **Menu** button to exit.

Diagnostics Menu: Reset System

Reinitialize the Outdoor Control Panel. Resetting the Outdoor Control Panel will not effect the system configuration settings.

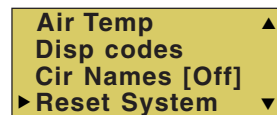

Right button: Press the Right button to reset system. The main screen will be displayed and communication will be established with the optional EasyTouch Indoor Control Panel if installed.

Diagnostics Menu: Flash Update

Use this feature to update the EasyTouch Outdoor Control Panel firmware. The EasyTouch motherboard must be connected to a personal computer (PC) in order to update the firmware.



Press the **Menu** button to exit the flash mode.

Section 3

Troubleshooting

Troubleshooting

Use the following troubleshooting information to help resolve problems that may occur when using the EasyTouch system. If by following the recommended actions you are still unable to resolve the problems, please contact Technical Support (see page vi).

Frequently Asked Questions (FAQ)

How do I setup a two-speed pump?

A two-speed pump operates using two relays and one or more circuits. The first relay turns the pump on or off. Assuming this is a filter pump, this circuit is controlled by the pool and spa circuits or any other circuit that may be tied to the filter pump (such as circuits with freeze protection, etc.). The second relay switches the pump from low speed to high speed. The default condition is low speed. Up to seven circuits may be assigned to trigger the pump to high speed. Note: These circuits do not switch the pump on.

To configure a two-speed pump relay, refer to “Settings Menu: 2-Speed Pump,” on page 42. For relay location and wiring (see page 60). The 2-Speed pump relay connector is plugged into the 2-SPD output on the EasyTouch motherboard.

Can I switch the heater on and change the temperature from the spa?

The heater may be switched on from the spa location using the iS4 Spa-Side remote or by the QuickTouch wireless remote controller. To learn more about these remotes and controllers, see page 6. However, the iS4 and QuickTouch wireless remote controller cannot adjust the water temperature.

How do I switch on solar heating?

The system must first be configured for solar heating. Go to the “Heat” menu (see page 25) and enable “Solar” as the heat source (**Settings Menu: Heat > Solar**). Note: Do not set solar as a heat pump. Then the heating method must be selected for each body of water.

EasyTouch Error Messages

Error Messages

If the system detects that a sensor is not connected to the EasyTouch load center or it is defective, an error message is displayed in the “Diagnostics” menu. The following lists the sensor errors.

Error Message	Possible Cause	Solution
Air Err (Displays on the Main Screen)	Air sensor not connected to the EasyTouch motherboard.	Check that the air sensor plug is connected to J21 connector on the motherboard. Check that the sensor wire is connected properly.
Air Temperature Err (Displays in the "Diagnostics" menu)	Air sensor not connected to the EasyTouch motherboard.	Check that the air sensor plug is connected to J21 connector on the motherboard.
Water Temperature Err (Displays in the "Diagnostics" menu)	Water sensor not connected to the EasyTouch motherboard.	Check that the water sensor plug is connected to J21 connector on the motherboard.
Solar Temperature Err (Displays in the "Diagnostics" menu)	Solar sensor not connected to the EasyTouch motherboard.	Check that the solar sensor plug is connected to J21 connector on the motherboard.

Self Test Error Codes

The “Self Test” feature is intended for use by service personnel. If after performing a control panel self test (see page 52) there were no errors detected, Code 0 is displayed, indicating that there were no problems and the test was successful. If a problem is detected during the test, an error code is displayed upon completion of the test. For example Code 3 would indicate a problem with the LEDs on the control panel. If multiple errors are detected, multiple code numbers are displayed. For example, Codes 4, 2, 1, would indicate problems detected with the buttons, LEDs, and the LCD backlight on the control panel.

The following lists the control panel self test error codes.

Error Code Table

Error Code	Description
Code 0	PASS - The control panel has no problems
Code 1	LCD backlight
Code 2	LCD contrast
Code 3	LEDs
Code 4	Switch (buttons)
Code 5	UART loopback test
Code 6	Sensor/Relay/Valves test

Maximum Programs Exceeded

The “Maximum Programs Exceeded” message displays in the “Schedules” menu if you try to create a new program after exceeding the 12 program limit. To create a new program you must first delete an existing program. For information about deleting a program, refer to “Schedule Menu” on page 27.

IntelliChlor Error Messages

IntelliChlor status and error messages are displayed in the “Chlorinator” menu (see page 53). Use the following information to resolve IntelliChlor system problems. To access the IntelliChlor menu, press **Menu > Diagnostics > Chlorinator**.

Status Message	Possible Cause	Solution
OK-NO ERRORS	IntelliChlor normal operating mode.	N/A
SUPER CHLORINATE	IntelliChlor is in "Super Chlorination" mode for 24 hours.	IntelliChlor is in “Super Chlorination mode (see page 35 or details)
COM LINK ERROR	IntelliChlor communication error with EasyTouch motherboard.	Check cable from IntelliChlor to EasyTouch motherboard.
CHECK FLOW/PCB	Check IntelliChlor electrolytic cell.	Refer to IntelliChlor User’s Guide troubleshooting information.
LOW SALT	Add salt to pool water.	The water salt level is between 2500 ppm and 2900 ppm. The IntelliChlor will continue to produce chlorine at a reduced level. See IntelliChlor User’s Guide for details.
VERY LOW SALT	Not enough salt in pool.	The water salt level has fallen below 2500 parts per million (ppm). IntelliChlor will not produce chlorine until additional salt is added manually. See IntelliChlor User’s Guide for details.
HIGH CURRENT	Check IntelliChlor electrolytic cell.	Check IntelliChlor electrolytic cell controller. Refer to IntelliChlor User’s Guide troubleshooting information.
CLEAN CELL!!	Cell has calcium build up and requires cleaning.	Cell has calcium build up and requires cleaning. Refer to IntelliChlor User’s Guide for cleaning instructions.
LOW VOLTAGE	Check IntelliChlor electrolytic cell.	Refer to IntelliChlor User’s Guide troubleshooting information.

System Problem Diagnosis

Use the following information to resolve system problems.

Problem: The system works in Service Mode, but Indoor Control Panel fails to operate.

Symptom	Possible Cause	Solution
Indoor Control Panel has no power - (screen, blank, no LEDs, buttons not working).	Bad wiring run from Outdoor Control Panel/motherboard in the Load Center.	Verify cable and ensure no connections are broken. In some cases a wire is broken under the insulation. The two center wires of the four conductor cable are suspect (Green and Yellow)
Indoor Control Panel lights up, but fails to operate correctly. The unit will not turn equipment on/off, or may turn some items on, but not off and may not LEDs near buttons on control panel.	Defective Cable/wiring	Verify cable and ensure no connections are broken. In some cases a wire is broken under the insulation. The two center wires of the four conductor cable are suspect (Green and Yellow)

Problem: iS4 fails to operate.

Symptom	Possible Cause	Solution
iS4 fails to operate equipment.	iS4 is disabled.	See page 51 to enable the iS4.
	Defective Wiring	Verify iS4 setup. Ensure the iS4 in question has the expected circuit assignments, and is not assigned to unused circuits.
	Incorrect configuration or button setup.	See page 44 to setup the iS4 buttons.
	Defective iS4	Replace defective iS4
iS4 fails to operate only some of the switches, but others work fine.	Defective wiring on one or more iS4 leads	Verify wiring on motherboard and iS4.
	Incorrect configuration or circuit to switch assignment.	Verify motherboard connection.

Problem: iS104 fails to operate.

Symptom	Possible Cause	Solution
iS10 fails to operate equipment.	iS10 is disabled.	See page 51 to enable the iS10
	Defective Wiring	Verify iS10 setup. Ensure the iS4 in question has the expected circuit assignments, and is not assigned to unused circuits.
	Incorrect configuration or button setup.	See page 45 to setup the iS10 buttons.
	Defective iS10	Replace defective iS10
iS10 fails to operate only some of the switches, but others work fine.	Defective wiring on one or more iS10 leads	Verify wiring on motherboard and iS10.
	Incorrect configuration or circuit to switch assignment.	Verify motherboard connection.

Problem: The Quick Touch remote will not work, or will not work dependably.

Symptom	Possible Cause	Solution
POWER LED does not light on the Receiver board located in the plastic clam shell.	EasyTouch Load Center does not have power	Ensure power is being supplied and that the power center operates correctly without the receiver installed
	Defective cable or connection to the Load Center	Verify the function of the board using known good cable set. Check all wiring
	Defective Receiver board	Contact Technical Support
COMM LINK LED does not light or blink. In normal operation LED will blink at least every 2 seconds	Defective cable or connection to the Load Center	Verify the function of the board using known good cable set
	Defective receiver board	Replace receiver board
Address switches are incorrectly configured	Verify that the address switches on the transmitter and handheld receiver board are correct and match	Transmitter battery has failed
	Replace Transmitter battery	Defective Transmitter or Receiver
Unit functions, but some circuits do not work, or operate the incorrect circuit	QuickTouch configuration is incorrect	See page 47 to setup buttons
Unit fails to operate, or fails to operate dependably at range	Excessive electrical noise	Relocate the receiver away from "noisy" electrical equipment such as blower motors
	Too many obstructions between the transmitter and receiver	Relocate the receiver away from ground metal and obstructions
	Receiver unit is too near the ground	Relocate the receiver to maximize the distance between the receiver antenna and the ground

Problem: The Quick Touch remote will not work, or will not work dependably (Continued).

Symptom	Possible Cause	Solution
Unit seems to turn on or off circuits without the user / transmitter	A near by home is operating a similar wireless unit	Select an alternate address code for the transmitter and receiver. Change the switches on both receiver and remote to an alternate, but matching setting.
Unit dependably turns equipment ON, but once equipment is running it does not dependably turn equipment OFF, or range is greatly reduced when equipment is running	Undue electrical noise is being produced by one or more pieces of equipment in close proximity to the receiver.	Relocate the Receiver away from equipment such as blower motors. Relocate the receiver in a location that provides fewer obstructions to the area the user commonly operates the transmitter.
Unit operates, but has greatly reduced range compared to prior function	Transmitter Battery is failing.	Replace Transmitter battery (type 2032 3V).

First Time System Start-Up

The following information describes a basic system start-up procedure. Before you power up the EasyTouch system at the Load Center first check the following:

Check Electronics

Check that the following plugs are seated correctly on the EasyTouch Load Center motherboard. For connector locations, refer to the EasyTouch System Wiring Diagram on page 60.

- Relay connectors - **FLTR PUMP - AUX 1 - 7**
- Temperature sensors connectors - **WATER, SOLAR, AIR**
- Transformer wire harness - **J1**
- Heater control connector - **ELEC HTR and GAS HEATER (J19)**

System Test

Follow the steps below to test the EasyTouch control panel to activate the heater, valves and pumps. This test assumes that all system equipment has been properly installed and connected to the EasyTouch Load center.

Testing Valve Actuators and Pumps:

Use the following steps to test the valve actuators (CVA24T) for proper rotation.

To test the valve actuators and pump:

1. Switch on the electrical power at the house breaker.
2. Switch on the EasyTouch Load Center. You may need to switch on the breakers on the Load Center.
3. Press the **Mode** button to enable “Service” mode.
4. Press the **Valve (V)** button to select “Pool” mode.
5. Press the **Filter Pump (F)** button to activate the filter pump. Water will be removed from the pool and returned to the pool. A spa bypass line divert a small amount of water to the spa. Make sure the filter pump turns on correctly. If the pump has two speeds: Press the button one time to run the pump in low speed. Press the button again to run the pump in high speed. Press the button again to switch the pump off. A Two-Speed pump has to be configured in the 2-Speed menu (see page 42).
6. Set both valve actuators (CVA-24T) for suction and return. Use the toggle switch on the rear of the CVA-24T to withdraw and return water from the pool.
7. Press the **Valves (V)** button. Step through all four valve positions: Pool, Spa, Fill, Drain. Make sure the valves turn on correctly and the water is moving in the correct direction for each position. If necessary, flip the actuator toggle switch to change the direction of the water.

Note: *With the filter pump operating, if water is not being removed and returned to the pool, it may be necessary to reverse the **RETURN** with **VLV A** (or **VLV B**) plugs on the EasyTouch motherboard.*

Testing the Auxiliary Relays

Affix the auxiliary relay labels to the appropriate buttons on the EasyTouch control panel and/or the EasyTouch Indoor Control Panel. If necessary, write the function on the control panel.

1. Step through the rest of the auxiliary buttons. Notice which button turns on which equipment. You may need to walk the property to find what each button turns on.
2. Write down what each button switches on, including the number of the circuit. You need this information when you set up the Indoor Control Panel.
3. Label the circuit buttons on the outdoor control panel and the EasyTouch Indoor Control Panel.

Setting up the EasyTouch wireless control panel for the first time

Setting up the EasyTouch wireless control panel

In order for the EasyTouch wireless control panel to communicate with the EasyTouch system outdoor control panel, the first time the wireless device is powered up it must first be assigned a unique communication address. For this process you need to access the menu for each control panel. For convenience it's easier to setup the wireless device at the outdoor control panel.

From the EasyTouch load center outdoor control panel

1. Switch power on to the EasyTouch load center.
2. Press **Menu** button, and select **Settings > Address** and press the **Right** arrow button.

Address Wireless
Scanning ...

Address Wireless
Sending Address..
<MENU>

The EasyTouch outdoor control panel will display "Scanning..." for about five seconds while it searches for the EasyTouch wireless device within range of the transceiver antenna. After the scanning process has finished, "Sending Address" is displayed. The system is now waiting to lock on to the EasyTouch wireless control panel. Proceed to step 3.

From the EasyTouch wireless control panel

3. Press the **Power On** button located on the front of the wireless device.
Note: After replacing depleted batteries a check battery message is displayed on the screen. Press the **MENU** button twice to continue.
4. Press **Menu** button, and select **Settings > Address** and press the **Right** arrow button.
5. Select "Address" and press the **Right** arrow button to lock on to the unique address that is being transmitted from the outdoor control panel.

NO ADDRESS

▶ Address
Abort

***Note:** If you choose "Abort," the device can continue to operate using the factory default address. If the outdoor control panel has been previously addressed, the wireless may not operate the system. Each time the device is switched on the "NO ADDRESS" will be displayed. This mode is not recommended for permanent use.*

6. After selecting "Address" the wireless device unit will lock on to a unique address and display "Found ADDRESSED." Press the **Menu** button to save and exit this mode. The device is ready for operation.

Address Lock
Found
ADDRESSED
<MENU>

***Note:** "Unit Mismatch" displays if the outdoor control panel has an existing system image. See page 63 for details.*

Unit Mismatch ▲
Download from
Outdoor ▼

7. **On the outdoor control panel:** Press the outdoor control panel **MENU** button three times to exit the "Sending Address" mode and return to the main screen. The system will continue to transmit an address until the Menu is button is pressed to stop the process.

***Note:** To readdress the EasyTouch wireless device, repeat steps 2 through 7 on the wireless device to restart the address process.*

Synchronizing control panels

If the EasyTouch outdoor control panel was previously setup with specific pool and spa information and an additional indoor or wireless control panel with factory default information is installed, during the installation process the outdoor control panel will automatically download the system information to the connected control panel. If the outdoor, indoor or wireless control panels have different revision levels or contain previous setup information, you can choose which system image to upload or download.

Synchronizing control panels is initiated from the indoor or wireless control panel. The following describes how to synchronize an indoor or wireless control panel.

Download from outdoor to indoor control panel

- Press the **Menu** button to download the system image from the EasyTouch outdoor control panel.



Upload to outdoor from indoor control panel

- Press the **Up/Down** button to access the "Upload" screen.
- Press the **Menu** button to upload the system image from the indoor or wireless control panel to the EasyTouch outdoor control panel.

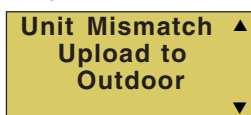

Note: To erase existing control panel system information, use the "Erase EEPROM" feature. Refer to "Erase EEPROM" on page 49 for more information.

Wiring ThermalFlo to EasyTouch

Be sure to check the ThermalFlo terminal block wire colors and pinouts (located on the back of the Auto Set board) before connecting it to the EasyTouch COM port on the motherboard. See the wiring table below for the pin configuration. For ThermalFlo setup information, see page 36.

IMPORTANT: On the ThermalFlo AutoSet board ONLY CONNECT PIN 3 (YELLOW) and PIN 2 (GREEN) to the EasyTouch COM port pins YELLOW and GREEN respectively. Do not use pin 1 or pin 4 on the AutoSet board or the EasyTouch motherboard. These pins are not used.

Wiring Description

EasyTouch COM port wire color	Description	ThermalFlo pin number and wire color
PIN 4 (RED) NOT USED	+15 VDC	PIN 4 (RED) NOT USED
PIN 3 (YELLOW)	+ DATA	PIN 3 (YELLOW)
PIN 2 (GREEN)	- DATA	PIN 2 (GREEN)
PIN 1 (BLACK) NOT USED	GROUND	PIN 1 (BLACK) NOT USED

Blank Page

Section 4

Compool/EasyTouch Upgrade Kit Installation

This section describes how to install the Compool/EasyTouch control panel upgrade kit into a Compool load center or power center. For Compool CP3xxx models complete upgrade list, see page 66 and 67. Compool models TimeMaster, CP/LX100, CP1000, CP2000, CP3000 can also be upgraded to an EasyTouch system.

- To upgrade a Compool control panel in a power center (without sub-panel), only requires the replacement of the Compool control panel with the EasyTouch control panel (See page 68).
- To upgrade the Compool/EasyTouch control panel in a Compool load center (with breaker sub-panel), requires removal and reinstallation of the existing transformer. *Note: To upgrade Compool TimeMaster, CP/LX100, CP1000, CP2000 models requires Compool/EasyTouch control panel upgrade kit with transformer P/N 521247). Otherwise CP3xxx systems require P/N 521107.*

Compool/EasyTouch Upgrade Kit for:

- **Compool CP-3xxx series (not CP3830)**
- **LX100 control systems**
- **CP100 control systems**
- **CP1000, CP2000, and CP3000 systems**



Compool 3xxx Load Center
(with breaker sub-panel)



Compool 3xxx Power Center
(without breaker sub-panel)



Compool LX100 Power Center

Compool/EasyTouch Upgrade Models

The following tables list detailed upgrade information for Compool CP3xxx models. Compool TimeMaster, CP/LX100, CP1000, CP2000, CP3000 can also be upgraded to an EasyTouch system.

Singel Body Systems	COMPOOL				EASYTOUCH	
	CP3810SLX	CP3810SX	CP3820SLX	CP3820SX	EasyTouch 4P, 4PSC	EasyTouch 8P, 8PSC
Features						
Enclosure Type	Metal	"Plastic (Blk)"	Metal	Plastic (Blk)	Metal	Metal
Max. Circuits	Filter + 7Aux	Filter + 7Aux	8Aux	8Aux	Filter + 3Aux	Filter + 7Aux
Pwr Relays	4 Std/ 8 Max	4 Std/ 8 Max	8 Std/ 8 Max	8 Std/ 8 Max	4 Std/ 4 Max	8 Std/ 8 Max
Relay Amps	20 A (2HP)	20 A (2HP)	20 A (2HP)	20 A (2HP)	25 A (3HP)	25 A (3HP)
Compatible Heaters	Gas/Elec Solar/Heat Pump	Gas/Elec Solar/Heat Pump	Gas/Elec Solar/Heat Pump	Gas/Elec Solar/Heat Pump	Gas/Elec Solar/Heat Pump	Gas/Elec Solar/Heat Pump
Circuit Brkr Panel & Capacity	4 @ 230V	None	4 @ 230V	None	4 @ 230V	4 @ 230V
Valve Actuator Outputs (Aux)	1 Std/ 4 Max	1 Std/ 4 Max	? Std/ ? Max	? Std/ ? Max	2 Std/ 2 Max	2 Std/ 2 Max
Valve Actuators Included w/ System	0	0	0	0	0	0
Indoor Control Support	Std (Required)	Std (Required)	Std (Required)	Std (Required)	Accessory	Accessory
Temp Sensors	Compool Type water (25ft/air (1ft)	Compool Type water (25ft/air (1ft)	Compool Type water (25ft/air (1ft)	Compool Type water (25ft/air (1ft)	IntelliTouch Type water(20ft)/air(40in)	IntelliTouch Type water(20ft)/air(40in)
Transformer Type	Pri: 115/230V Sec:10/18/24 V	Pri: 115/230V Sec:10/18/24 V	Pri: 115/230V Sec:10/18/24 V	Pri: 115/230V Sec:10/18/24 V	Pri: 115/230V Sec:12/18/24 V	Pri: 115/230V Sec:12/18/24 V

Compool/EasyTouch Upgrade Models (Single Body Systems)

Shared Equipment Systems	COMPOOL							EASYTOUCH	
	CP3400TLX	CP3400TX	CP3600TLX	CP3600TX	CP3800TLX	CP3800TX	EasyTouch 4, 4SC	EasyTouch 8, 8SC	
Features									
Enclosure Type	Metal	Plastic (Blk)	Metal	Plastic (Blk)	Metal	Plastic (Blk)	Metal	Metal	
Max. Circuits	Filter + 3Aux	Filter + 3Aux	Filter + 5Aux	Filter + 5Aux	Filter + 7Aux	Filter + 7Aux	Filter + 3Aux	Filter + 7Aux	
Pwr Relays	4 Std/ 4 Max	4 Std/ 4 Max	6 Std/ 6 Max	6 Std/ 6 Max	8 Std/ 8 Max	8 Std/ 8 Max	4 Std/ 4 Max	8 Std/ 8 Max	
Relay Amps	20 A (2HP)	20 A (2HP)	20 A (2HP)	20 A (2HP)	20 A (2HP)	20 A (2HP)	25 A (3HP)	25 A (3HP)	
Compatible Heaters	Gas/Elec Solar/Heat Pump	Gas/Elec Solar/Heat Pump	Gas/Elec Solar/Heat Pump	Gas/Elec Solar/Heat Pump	Gas/Elec Solar/Heat Pump	Gas/Elec Solar/Heat Pump	Gas/Elec Solar/Heat Pump	Gas/Elec Solar/Heat Pump	
Circuit Brkr Panel & Capacity	4 @ 230V	None	4 @ 230V	None	4 @ 230V	None	4 @ 230V	4 @ 230V	
Valve Actuator Outputs (Aux)	1 Std/ 4 Max	1 Std/ 4 Max	1 Std/ 4 Max	1 Std/ 4 Max	1 Std/ 4 Max	1 Std/ 4 Max	2 Std / 2 Max	2 Std / 2 Max	
Valve Actuators Included w/ System	2	2	2	2	2	2	2	2	
Indoor Control Support	Std (Required)	Std (Required)	Std (Required)	Std (Required)	Std (Required)	Std (Required)	Accessory	Accessory	
Temp Sensors	Compool Type water (25ft/air (1ft)	Compool Type water (25ft/air (1ft)	Compool Type water (25ft/air (1ft)	Compool Type water (25ft/air (1ft)	Compool Type water (25ft/air (1ft)	Compool Type water (25ft/air (1ft)	IntelliTouch Type water(20ft/air(40in)	IntelliTouch Type water(20ft/air(40in)	
Transformer Type	Pri: 115/230V Sec:10/18/24 V	Pri: 115/230V Sec:10/18/24 V	Pri: 115/230V Sec:10/18/24 V	Pri: 115/230V Sec:10/18/24 V	Pri: 115/230V Sec:10/18/24 V	Pri: 115/230V Sec:10/18/24 V	Pri: 115/230V Sec:12/18/24 V	Pri: 115/230V Sec:12/18/24 V	

Compool/EasyTouch Upgrade Models (Shared Equipment Systems)

Installing Compool/EasyTouch Upgrade Control Panel (with or without Transformer Kit)

The following procedure describes how to install the Compool/EasyTouch upgrade control panel (with or without the transformer kit) in a Compool power center (without breaker sub-panel). For Compool/EasyTouch upgrade control panel (with or without the transformer kit) in a Compool load center (with breaker sub-panel), see page 70.

Risk of electrical shock or electrocution:

⚠ DANGER



This equipment must be installed by a licensed or certified electrician or a qualified pool service professional in accordance with the National Electrical Code and all applicable local codes and ordinances. Improper installation will create an electrical hazard which could result in death or serious injury to pool users, installers, or others due to electrical shock, and may also cause damage to property.

Compool Power Center (without sub-panel)

For Compool CP2000 and older systems the existing transformer is removed and replaced with the Compool/EasyTouch Upgrade with Transformer Kit (TimeMaster, CP/LX100, CP1000, CP2000) P/N 521247. Otherwise, CP3xxx systems require P/N 521107. See page 72. The new transformer (3 wires) supplies the correct power for the EasyTouch circuit board. Remove the old transformer along with the attached terminal block and wires and discard. The transformer can be configured for 115 VAC or 230 VAC input power (as shown on page 71).

To remove the Compool control panel (see illustration on page 69):

⚠ WARNING Switch the main AC power OFF to the Compool power center

1. Unlatch the Compool power center front door and open the door (illustration below shows door removed).
2. Loosen the control panel retaining screw and open the control panel.
3. Disconnect all connectors from the Compool circuit board. For connector locations, see “Compool Circuit board Wiring Diagram” on page 77.
4. To remove the control panel from the power center, open the control panel/face plate to the widest position then lift up the control panel/face plate to release it from its two hinges.
5. **To install the Compool/EasyTouch Upgrade Control Panel, see instructions below.**
6. **To remove and replace the existing Compool transformer, see instructions on page 70.**

To install the Compool/EasyTouch upgrade control panel (see illustration on page 69):

⚠ WARNING Switch the main AC power OFF to the Compool power center

1. Mount the Compool/EasyTouch control panel/face plate on the power center hinges.
2. Connect all the necessary connectors to the EasyTouch circuit board. For connector locations, see “Compool/EasyTouch Upgrade Circuit board Wiring Diagram” on page 76.
3. Close the control panel/face plate and tighten the retaining screw.
4. Close the front door and the latch.

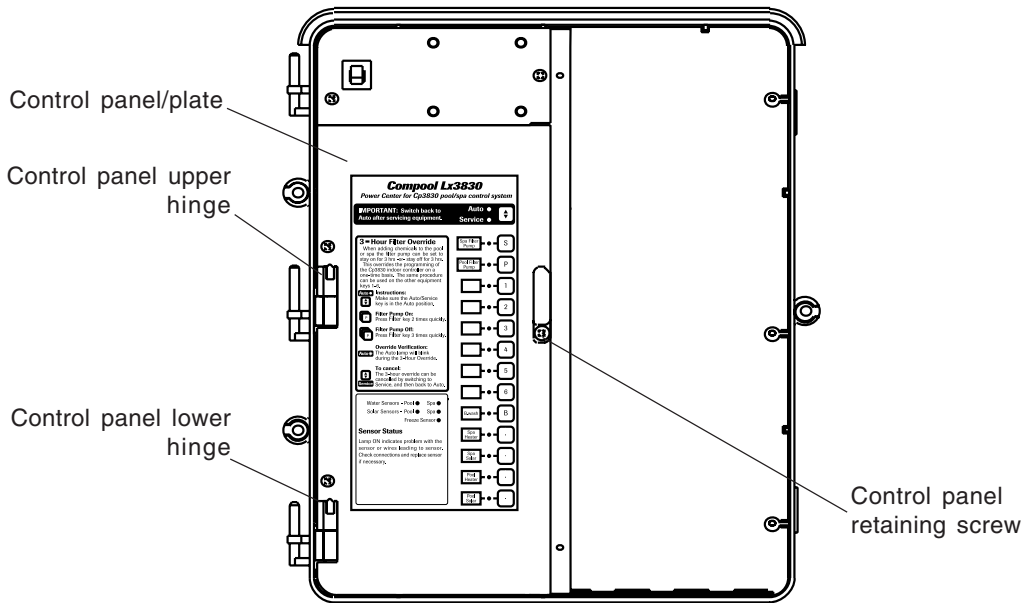

Compool power center (without breaker sub-panel)

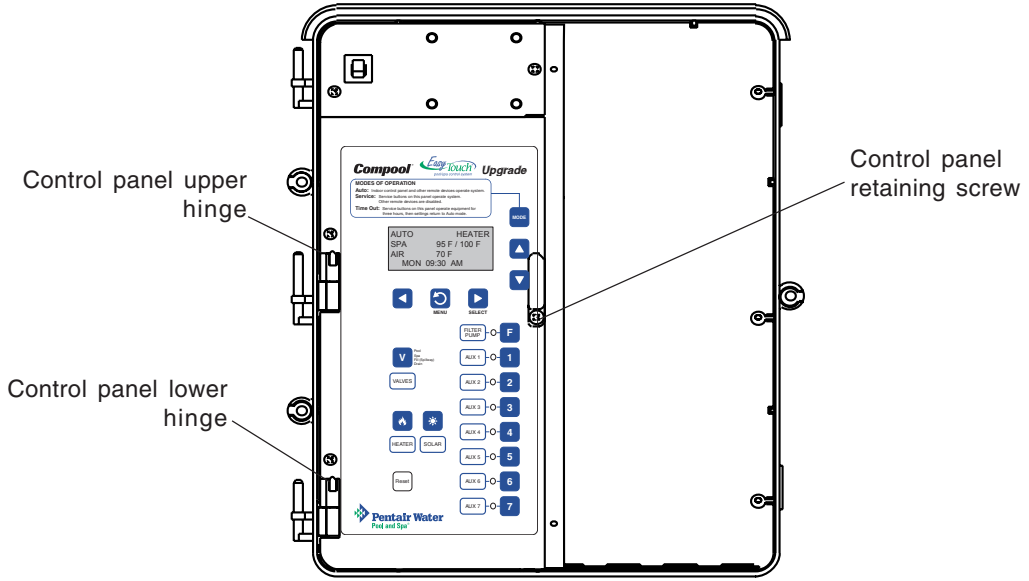

Compool Power Center upgraded with Compool/EasyTouch Control Panel

Removal/Replacement of Compool Power Center Transformer Assembly:

⚠ WARNING Switch the main AC power OFF to the Compool power center

For Compool CP2000 and older systems remove the existing Compool transformer and replace it with the transformer in the Compool/EasyTouch Upgrade with Transformer Kit (P/N 521247).

To remove and replace the Compool power center transformer assembly:

1. Remove the four (4) screws securing the transformer assembly. Save the screws for reinstallation. Leave the transformer assembly in place.
 - a) Remove the three (3) screws securing the service panel to expose the high voltage compartment in the right side of the load center.
 - b) Disconnect the transformer wire and the main input AC power wires from the BLUE TERMINAL BLOCK located in the high voltage compartment of the power center.
 - c) Remove the terminal block by lifting the tab on the right side of the block. Remove the terminal block and the transformer with attached wires from the power center.
2. **To replace the Compool/EasyTouch upgrade transformer kit), see page 71.**

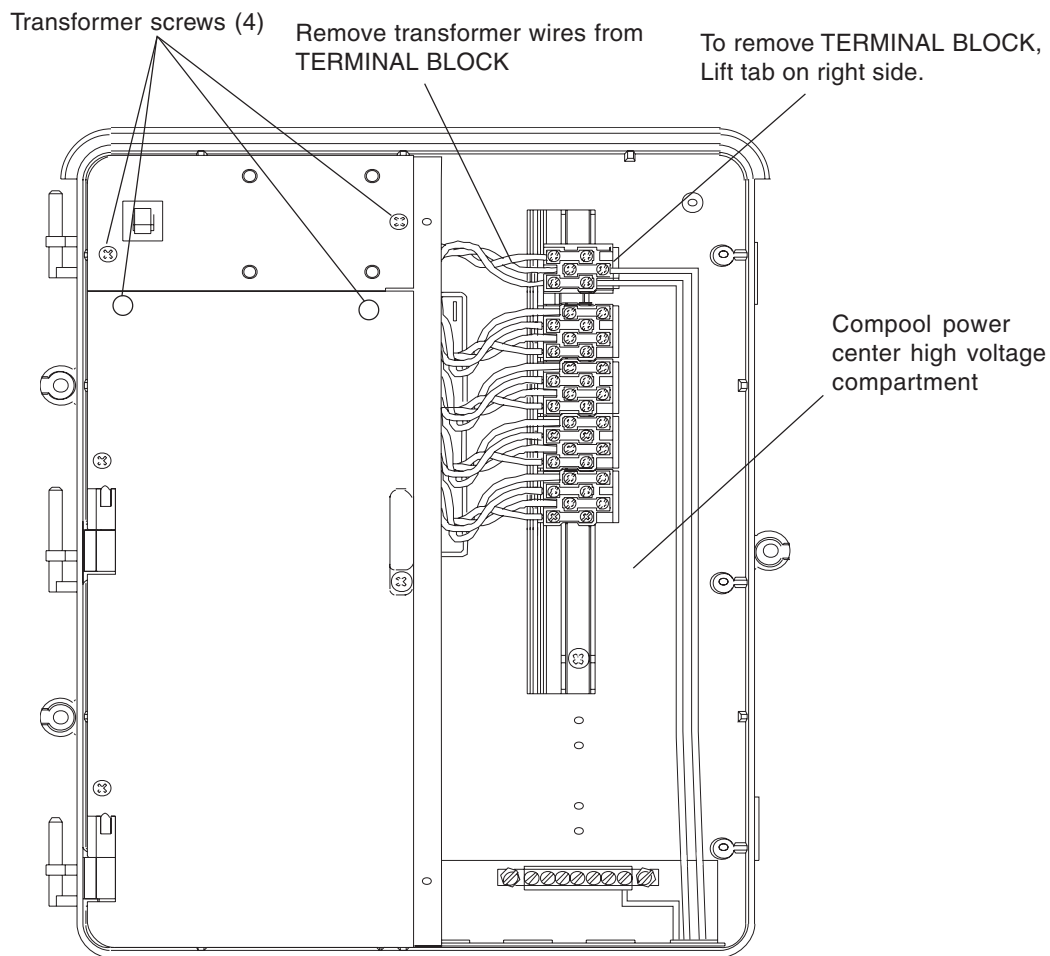

Compool power center

To install the Compool/EasyTouch Upgrade Transformer Assembly:

⚠ WARNING Switch the main AC power OFF to the Compool power center

1. Mount the new transformer assembly above the low voltage compartment of the power center. Route the three (3) wires through the bushing in the high voltage barrier. See illustration on page 72.
2. Reuse the four mounting screws to secure the transformer assembly.
3. In the high voltage compartment, affix the wiring labels (included) either side of the “blue terminal block” and connect the wires as shown below. Note: You will need to cut the new labels to fit over the existing labels.
4. Mount the new “BLUE TERMINAL BLOCK” (included) onto the mounting rail in the high voltage compartment of the load center. Press down to snap in place. Reconnect wiring for the transformer and input AC power.
5. In the low voltage compartment, plug the transformer assembly cable into the socket at the top of the Compool/EasyTouch circuit board. See “Compool/EasyTouch Upgrade Circuit board Wiring Diagram” on page 76.
6. Mount the service panel over the high voltage compartment and secure with the three screws.

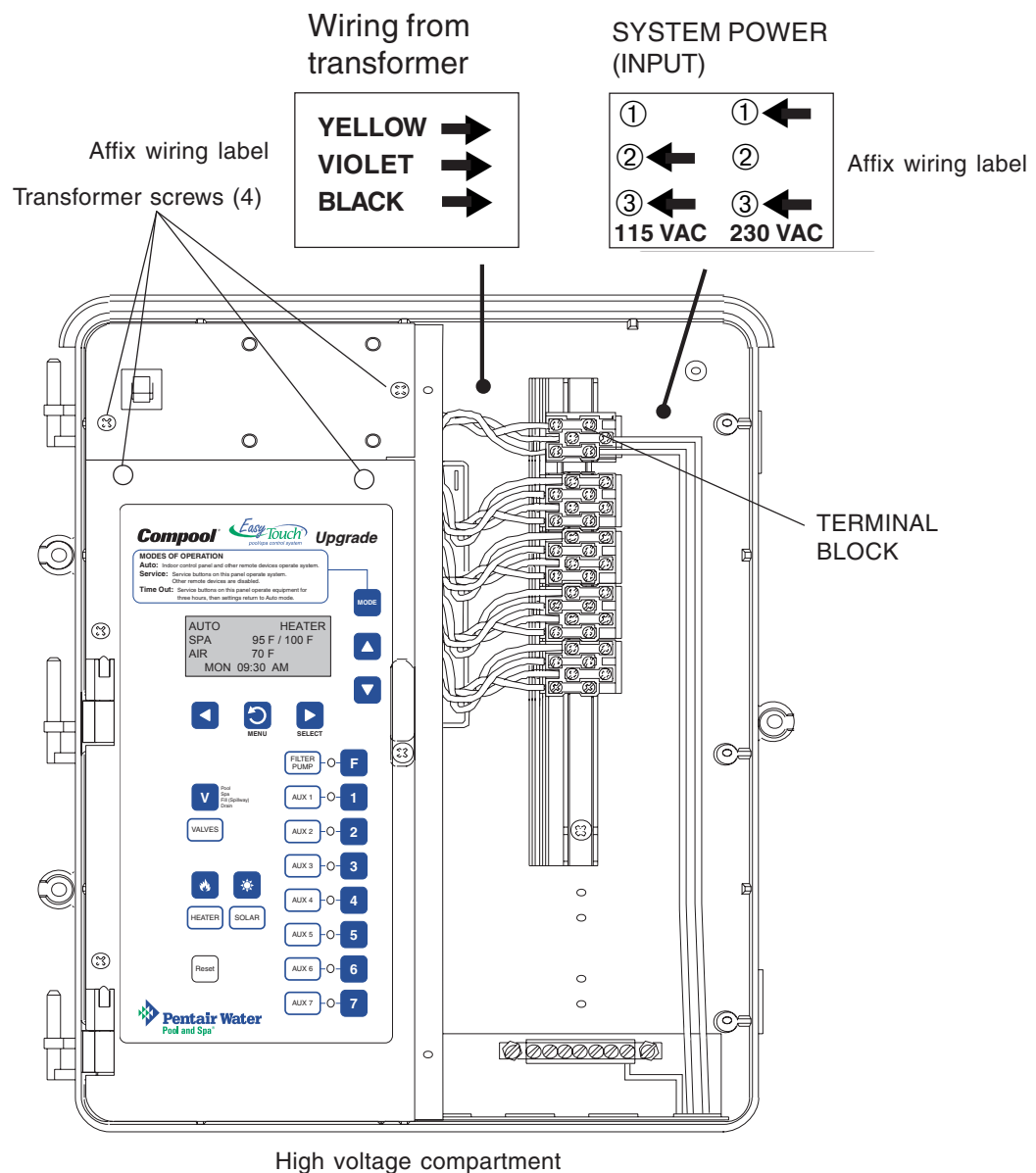

Compool Load Center (with breaker sub-panel)

To upgrade the Compool/EasyTouch control panel in a Compool load center (with breaker sub-panel), requires temporary removal of the existing transformer to allow the removal of the Compool control panel from the load center and the installation of the Compool/EasyTouch control panel.

To upgrade the Compool/EasyTouch control panel in a Compool load center (with breaker sub-panel), requires removal and reinstallation of the existing transformer. **Note: To upgrade Compool TimeMaster, CP/LX100, CP1000, CP2000 models requires Compool/EasyTouch control panel upgrade kit with transformer P/N 521247). Otherwise CP3xxx systems require P/N 521107.** The new transformer (3 wires) supplies the correct power for the EasyTouch circuit board. Remove the old transformer along with the attached terminal block and wires and discard. The transformer can be configured for 115 VAC or 230 VAC input power (as shown on page 75).

To remove the Compool control panel and transformer assembly:

⚠ WARNING Switch the main AC power OFF to the Compool load center

1. Unlatch the Compool power center front door and open the door.
2. Loosen the control panel retaining screw and open the control panel into its widest position.
3. Remove the four (4) screws securing the transformer assembly. Save the screws for reinstallation. Leave the transformer assembly in place.
4. Open the control panel/face plate to its widest position.
3. Disconnect all connectors from the Compool circuit board. For connector locations, see “Compool Circuit board Wiring Diagram” on page 77. **Note: If the Compool load center has a time clock installed (TimeMaster/CP100 models) in the top of the Compool control panel, remove the three screws securing the time clock and remove the time clock. This allows access to the Compool transformer bracket (see illustration on page 73).**
4. To remove the Compool control panel from the load center; while holding the transformer, carefully lift up the control panel/face plate and release it from its two hinges. Remove it from the load center.

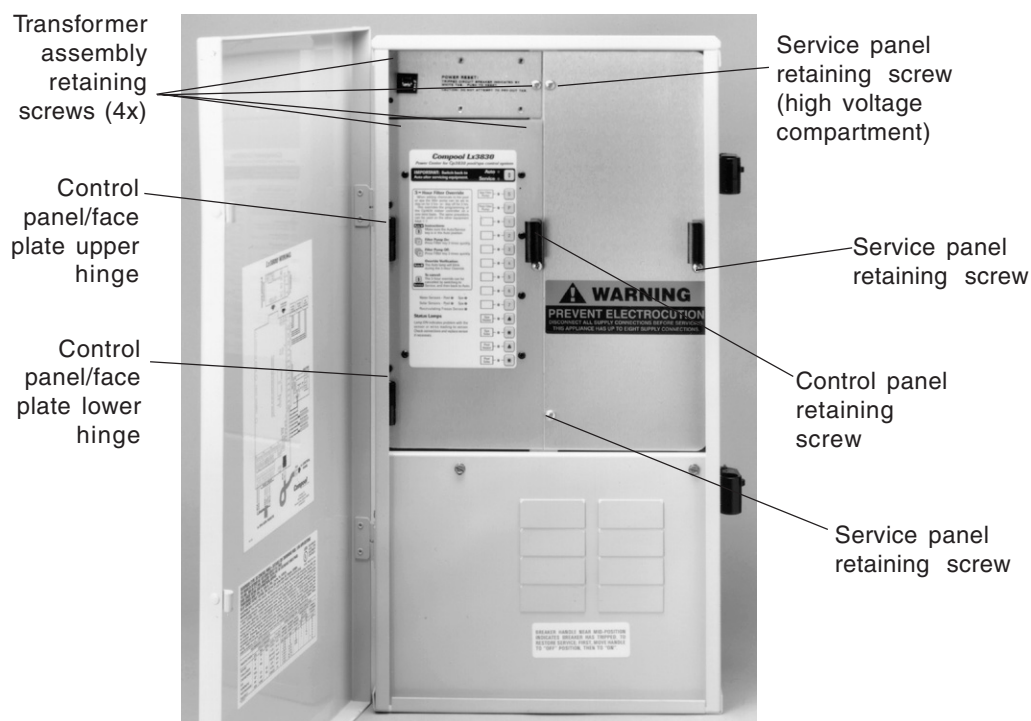

Compool power center (without breaker sub-panel)

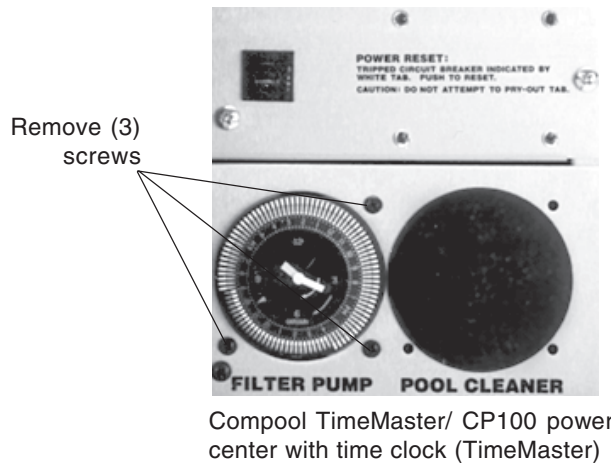

Removal of Compool transformer assembly:

5. **For Compool CP2000 and older systems** remove the existing Compool transformer and replace it with the Compool/EasyTouch Upgrade Transformer (P/N 521247).
 - a) Remove the three (3) screws securing the service panel to expose the high voltage compartment in the right side of the load center.
 - b) Disconnect the transformer wire and the main input AC power wires from the BLUE TERMINAL BLOCK located in the high voltage compartment of the power center.
 - c) Remove the terminal block by lifting the tab on the right side of the block. Remove the terminal block and the transformer with attached wires from the power center.
6. **To install the Compool/EasyTouch upgrade control panel (and transformer), see “Installing the Compool/EasyTouch control panel in a Compool Load Center with sub-panel” on page 74.**

Remove terminal block (wires are connected to transformer)

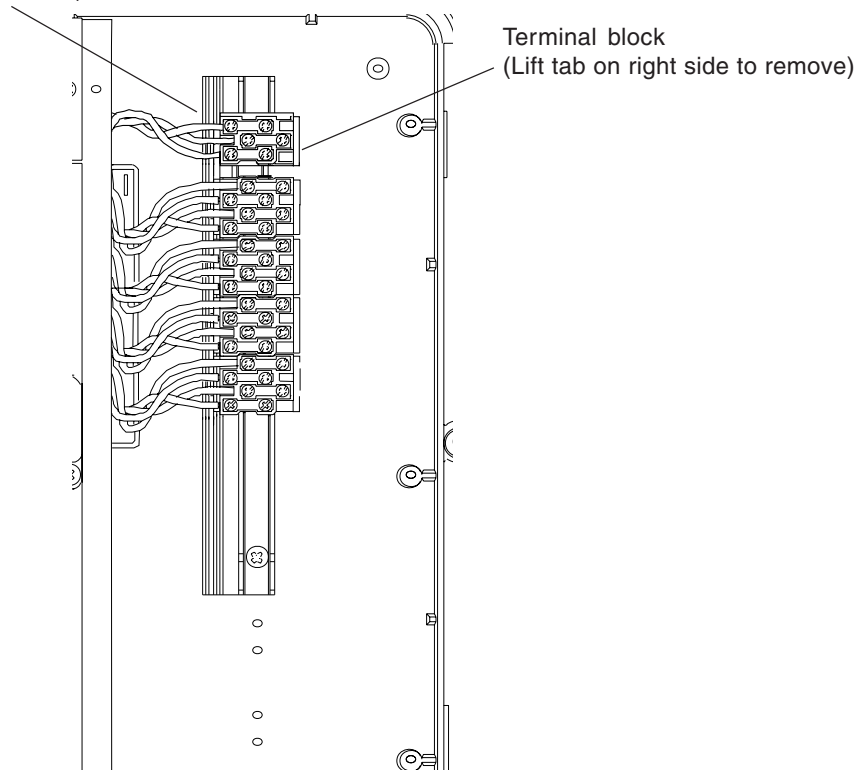

Compool load center high voltage compartment

Installing the Compool/EasyTouch Upgrade Control Panel (Compool Load Center with sub-panel)

⚠ WARNING Switch the main AC power OFF to the Compool power center

To install the Compool/EasyTouch control panel:

1. Hold the transformer assembly to allow the control panel to be mounted, then slide the control panel onto the load center hinges.
2. Mount the transformer assembly in position. Reuse the four mounting screws to secure the transformer assembly.
3. Connect all the necessary connectors to the EasyTouch circuit board. For connector locations, see “Compool/EasyTouch Upgrade Circuit board Wiring Diagram” on page 76.

Note: If replacing the transformer, continue with “Installing the Compool/EasyTouch Transformer in a Compool Load Center (with sub-panel)” below.

4. Close the control panel and tighten the retaining screw.
5. Place the front door on its hinges. Tighten the hinge nut.
6. Close the front door and close the latch.

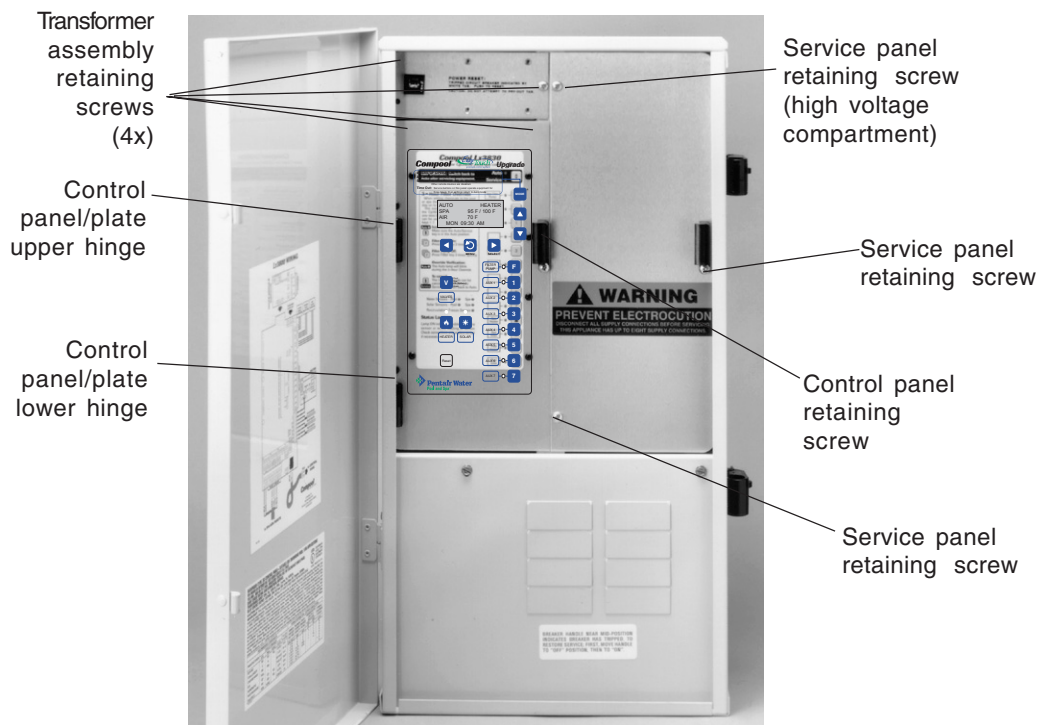

Compool power center (without breaker sub-panel)

Installing the Compool/EasyTouch Upgrade Transformer in a Compool Load Center (with sub-panel)

For Compool CP2000 and older systems the existing transformer is removed and replaced with the transformer included with the Compool/EasyTouch Upgrade with Transformer Kit (P/N 521247). Otherwise, CP3xxx systems require P/N 521107. See page 70. The new transformer (3 wires) supplies the correct power for the EasyTouch circuit board. Remove the old transformer along with the attached terminal block and wires and discard. The transformer can be configured for 115 VAC or 230 VAC input power (as shown on page 75).

⚠ WARNING Switch the main AC power OFF to the Compool load center

To install the Compool/EasyTouch Upgrade Transformer Assembly:

1. Mount the new transformer assembly above the low voltage compartment of the load center. Route the three (3) wires through the bushing in the high voltage barrier. See illustration on page 72.
2. Reuse the four mounting screws to secure the transformer assembly.
3. In the high voltage compartment, affix the wiring labels (included) either side of the “blue terminal block” and connect the wires as shown below. Note: You will need to cut the new labels to fit over the existing labels.
4. Mount the new “BLUE TERMINAL BLOCK” (included) onto the mounting rail in the high voltage compartment of the load center. Press down to snap in place. Reconnect wiring for the transformer and input AC power.
5. In the low voltage compartment, plug the transformer assembly cable into the socket at the top of the Compool/EasyTouch circuit board. See “Compool/EasyTouch Upgrade Circuit board Wiring Diagram” on page 76.
6. Mount the service panel over the high voltage compartment and secure with the three screws.
7. Close the control panel plate and tighten the retaining screw.
8. Place the front door on its hinges. Tighten the hinge nut.
9. Close the front door and close the latch.

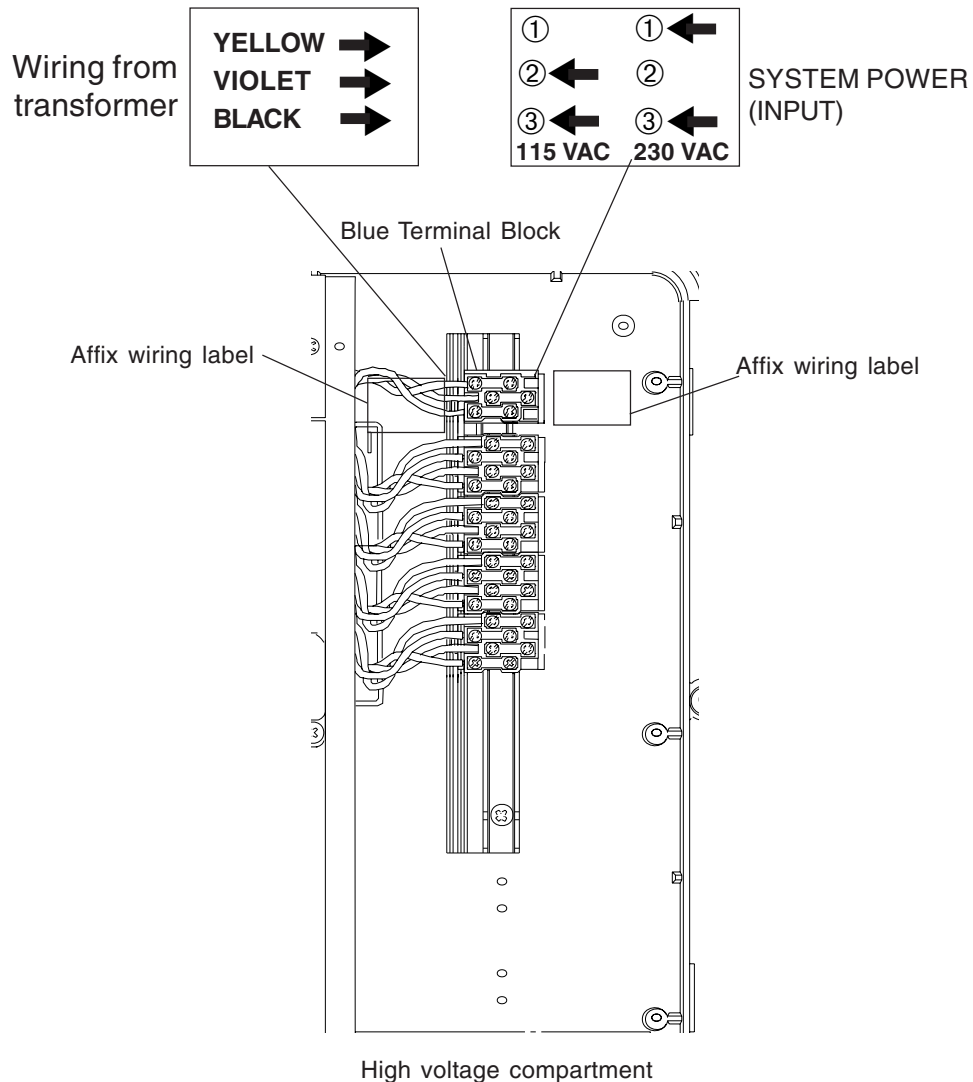

Compool® EasyTouch™ UPGRADE WIRING DIAGRAM

pool/spa control system

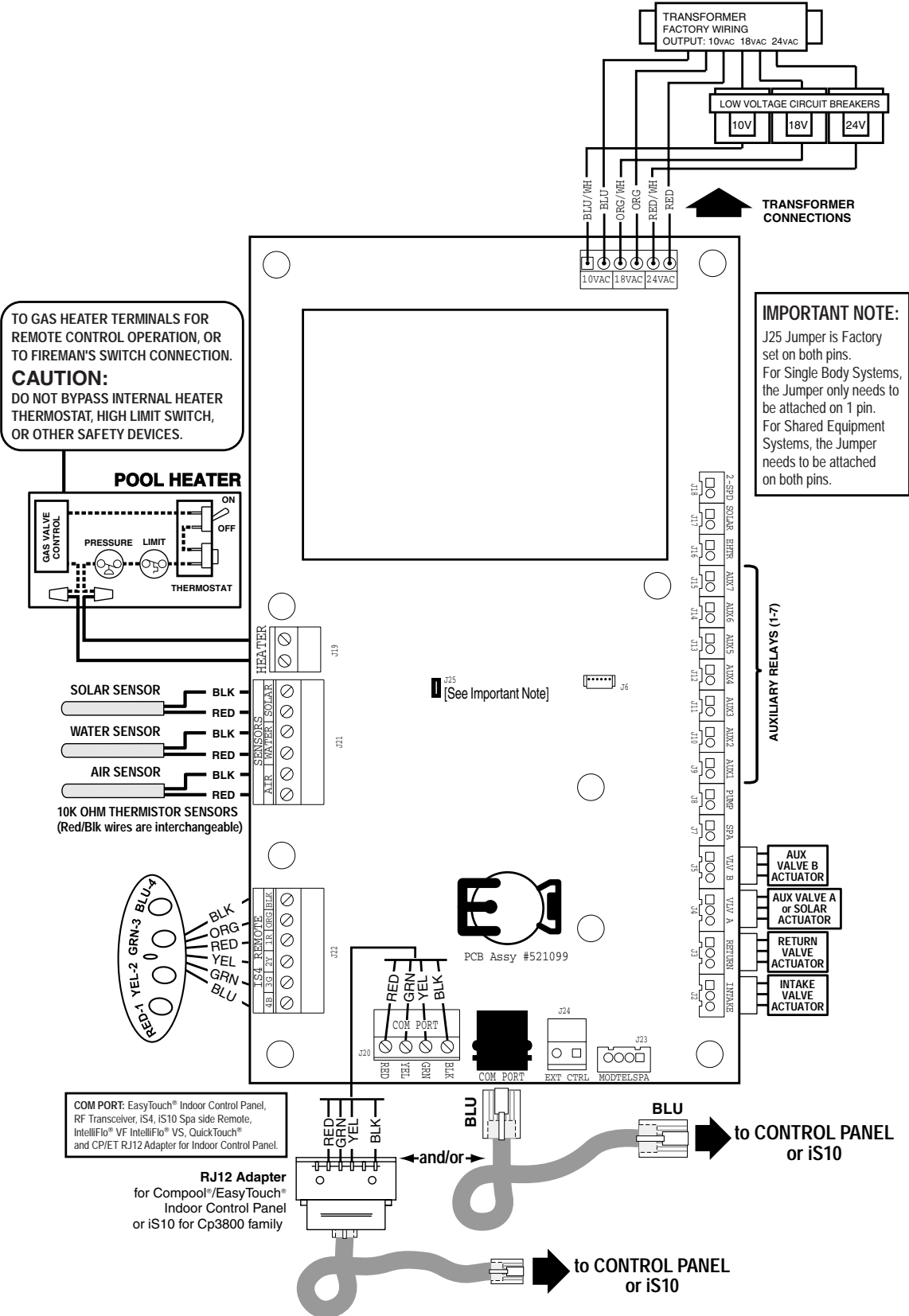

Compool/EasyTouch Upgrade Circuit board Wiring Diagram

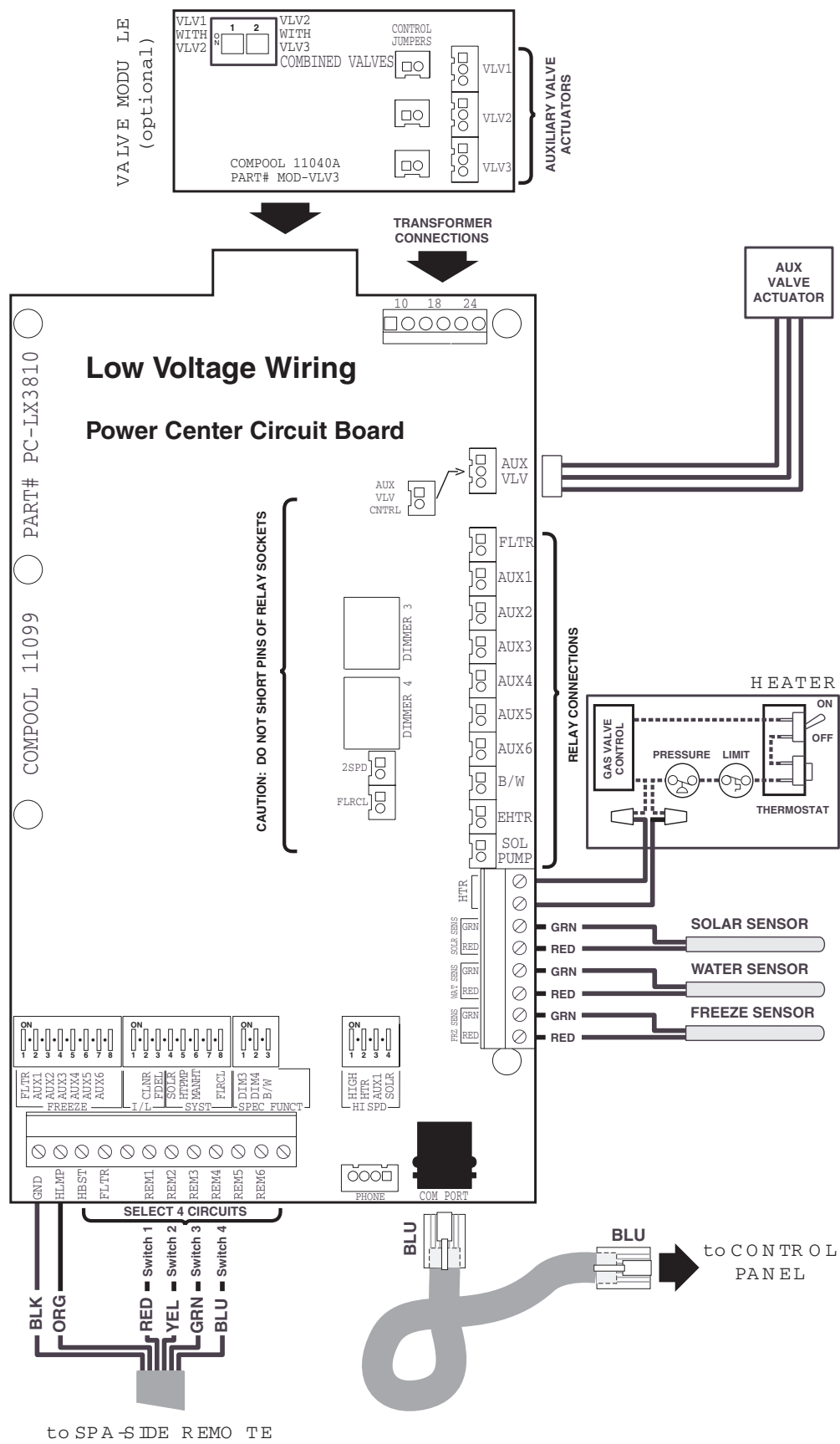

Compool 3810 Circuit board Wiring Diagram

NOTES

NOTES

