



OmniPL Retrofit Kit

Automation and Chlorination

Operation Manual



The image shows the components of the OmniPL Retrofit Kit: a white control panel with a screen, a blue printed circuit board (PCB) labeled 'OmniPL', a green PCB, a black cable, and a small white cable with a connector.

Contents	
Introduction.....	4
Bodies of Water.....	7
Favorites.....	19
Config.....	27
Firmware Upgrade.....	29
Service Mode.....	29
Simple Mode.....	33
Web Enabled Control....	35
Warranty.....	37

HLXPROUPG

**REGISTER
NOW**
to extend your
WARRANTY

see back of manual for details

Hayward Industries
400 Connell Drive, Suite 6100
Berkeley Heights, NJ 07922
Phone: (908) 355-7995
www.hayward.com



HAYWARD®

IMPORTANT SAFETY INSTRUCTIONS

When using this electrical equipment, basic safety precautions should always be followed, including the following:

- **READ AND FOLLOW ALL INSTRUCTIONS**
- **WARNING:** Disconnect all AC power during installation.
- **WARNING:** Water in excess of 100 degrees Fahrenheit may be hazardous to your health.
- **WARNING:** To reduce the risk of injury, do not permit children to use this product unless they are closely supervised at all times.
- **WARNING:** Do not use the OmniPL to control fire pits or related equipment.
- A green colored terminal marked “Grounding” is located inside the wiring compartment. To reduce the risk of electric shock, this terminal must be connected to the grounding means provided in the electric supply service panel with a continuous copper wire equivalent in size to the circuit conductors supplying the equipment.
- One bonding lug for US models (two for Canadian models) is provided on the external surface. To reduce the risk of electric shock, connect the local common bonding grid in the area of the swimming pool, spa, or hot tub to these terminals with an insulated or bare copper conductor not smaller than 8 AWG US / 6 AWG Canada.
- All field installed metal components such as rails, ladders, drains, or other similar hardware within 3 meters of the pool, spa or hot tub shall be bonded to the equipment grounding bus with copper conductors not smaller than 8 AWG US / 6 AWG Canada.
- **SAVE THESE INSTRUCTIONS**



Table of Contents

Introduction	Idle and Home Screen.....	1
	Power Button.....	3
	Selecting a Body of Water.....	3
	Favorites.....	4
	Navigation Buttons.....	4
Bodies of Water Control Screens	Filter Pump.....	4
	Schedules.....	5
	Pump Speed.....	6
	Countdown Timer.....	8
	Heater.....	8
	Heater Priority.....	9
	Chlorinator.....	10
	pH Dispense.....	11
	ColorLogic.....	13
	Other Lights.....	14
	Cleaners.....	14
	Water Features.....	14
	Schedules Button.....	15
	Spillover.....	15
	Freeze Protect Override.....	16
Favorites	Alarms Button.....	16
	Daylight Button.....	17
	Features/Lights/Heaters/Backyard Buttons.....	17
	Favorites Button.....	18
	Themes Button.....	21
Config	Config Button.....	24
	Config Wizard.....	24
	System Info.....	24
	Backup Config.....	24
	Restore Config.....	25
	Display.....	25
	Network.....	25
	Web Server.....	25
	Date/Time.....	25
	Language.....	26
	Data Log.....	26
Service Mode	Service Mode.....	26
Upgrade	Upgrade Firmware.....	28
	Installing New Language.....	30
Simple Mode	Simple Mode.....	30
Web Enabled Control	Web Enabled Control.....	32
Warranty	OmniPL Limited Warranty.....	34



Introduction

This manual assumes that the OmniPL has been installed and configured according to the Installation Manual and is using the latest firmware version available from Hayward. The OmniPL can now be programmed with user desired settings such as schedules, themes, and favorites. This manual will also explain how to manually turn pool equipment on/off, program settings for specific equipment, view pool equipment status and conditions, and more.

Now that the initial configuration has been completed, the OmniPL will automatically go to the Home Screen or Idle Screen. All settings and operation functions can be accessed from the Home Screen. Note that if the OmniPL Control Pad is not touched for more than two minutes, the Idle Screen will be displayed.

Using the Control Pad

The OmniPL uses a local touchscreen terminal as the main interface with the device. Once configured, the OmniPL can be controlled remotely using various Hayward remote terminals or, when connected to the home's network, by Internet enabled devices such as computers, tablets and phones. The Control Pad must be used to access the Configuration Wizard. The Configuration Wizard is used for initial configuration (completed during the installation process) and for any changes to existing configuration.

Idle Screen

The OmniPL Control Pad will display the idle screen after two minutes of user inactivity. When the filter pump is on, the Idle Screen will display the current temperature of the Body of Water shown in the upper left corner. If the OmniPL is configured to control two Bodies of Water, the idle screen will toggle between both. On the right side of the screen, the air temperature will toggle with the date.

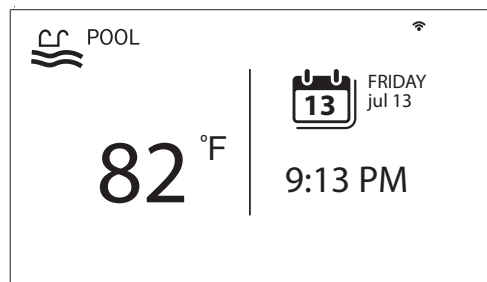

Home Screen

When the idle screen is touched, the OmniPL will display the Home Screen. This screen will give the user access to all functions, settings and configuration options.

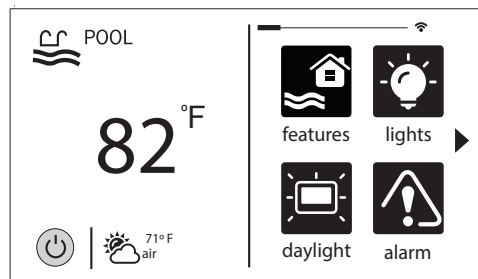



Power Button

The power button is displayed at all times when the OmniPL is not idle. When touched, it offers the following 4 functions:

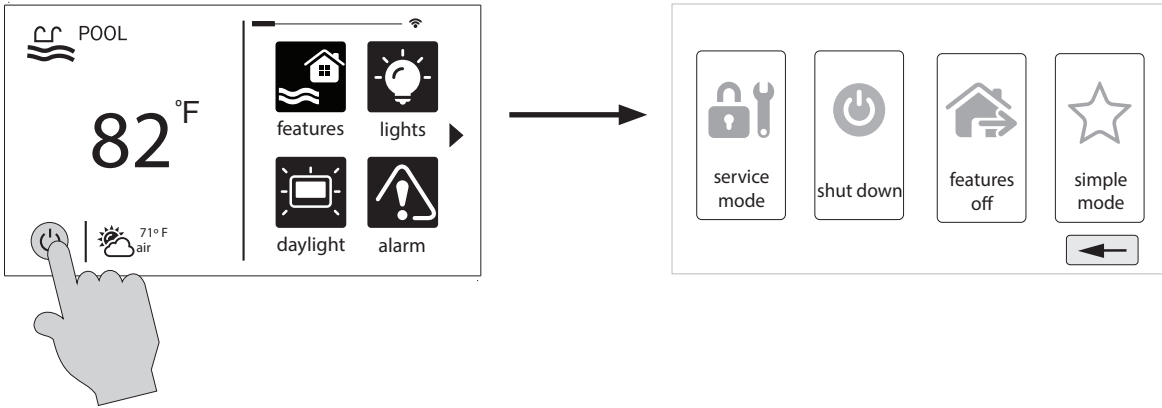

Shut Down - When Shut Down is selected, the OmniPL will turn off all pool equipment and report when it is safe to remove power. When this message is displayed, you can either power off the unit or restart the OmniPL by touching the large power button displayed on the left side of the screen.

Service Mode (page 26) - Service Mode will turn off all pool equipment and disable all remote controls including networked devices. Service Mode is useful to prevent scheduled operation and disable remote operation while servicing the pool. After selecting Service Mode, there are two options:

Service Mode (Standard): The OmniPL will remain in Service Mode until you manually exit. To exit Service Mode, touch the power button and select the Service Mode button again.

Service Mode Timed: Before entering Service Mode, you will select a Service Mode timeout. This is the amount of time that the OmniPL will stay in Service Mode before automatically exiting. The timeout can be set between 1-96 hours. There is no need to exit Service Mode manually.

Features Off - Features Off offers a quick way to turn off all equipment with a single touch of a button. Note that the filter pump, heater, lights and chlorination will continue to run if scheduled.

Simple Mode (page 30) - Simple Mode is a customizable screen that can be set up for quick access to your Favorites (page 18). You can set up only the Favorites that you want shown while in Simple Mode. Because it's customizable, Simple Mode can provide a convenient way to access the most common functions for owners as well as a handy solution to limit access to other users. For information on how to create and delete Simple Mode functions, refer to the "Favorites" section in this manual as well as page 30. The MSP ID number is needed when entering and exiting Simple Mode.

Selecting a Body of Water - Left Side of Home Screen

The left side of the Home Screen allows you to select and control a Body of Water. If more than one Body of Water is used (typically a pool and spa), pressing the left and right arrows in the middle of the screen will toggle between the Bodies of Water. If just a pool is configured, there will be no arrows shown.

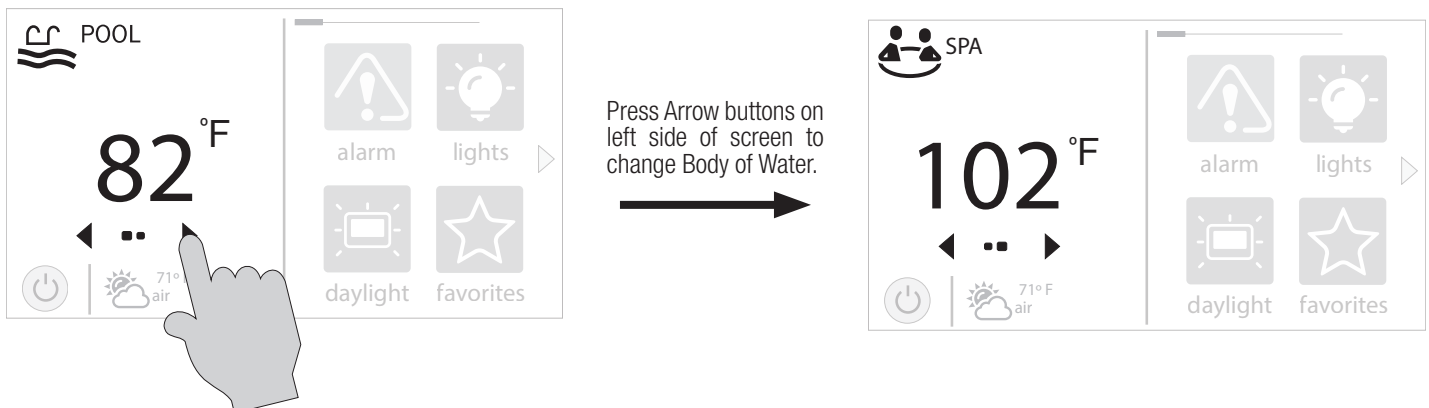

Features Screen - Controlling a Body of Water

When the desired Body of Water is displayed, touch the left side of the screen to advance to the Body of Water Features Screens. The items shown on the Features Screen relate to that Body of Water ONLY. To control a different Body of Water, select the desired Body of Water at the Home Screen first, then go to the Features Screens.

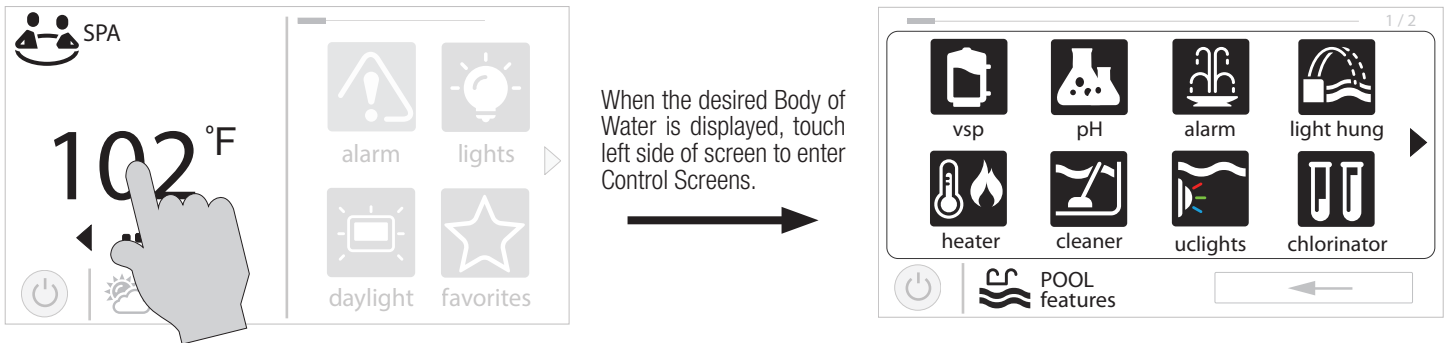

The various buttons shown in the Body of Water Features Screens are related to initial configuration. For example, if you configured a gas heater to heat the Spa Body of Water, the heater setting for the gas heater will be found in the Spa Features Screens.

Favorites - Right Side of Home Screen





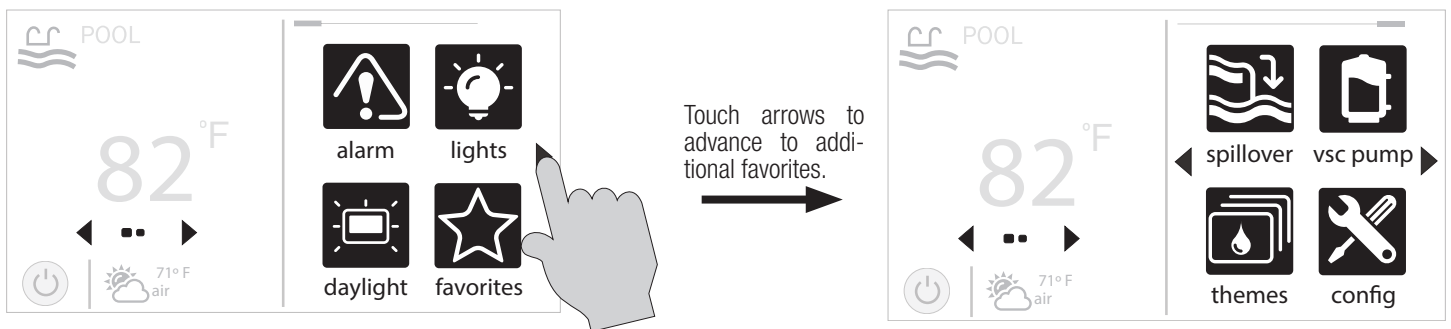





The right side of the Home Screen is Favorites. These buttons offer universal control for Backyard equipment and all Bodies of Water regardless of which one is displayed. Up to four Favorite buttons will be shown on the home screen. To access more Favorites, touch the arrows to the left or right of the Favorite buttons.

Note that some default buttons will appear on the Favorites Screen. These buttons are related to your initial configuration settings and are automatically created. In addition, custom "Favorite" buttons can also be added. The OmniPL supports up to 50 Favorites for quick easy access to commonly used functions.



Navigation

The OmniPL has been designed to be intuitive allowing most users the ability to navigate with little instruction. Below, a list of commonly used buttons are explained. As you navigate through the various screens, these buttons will likely be displayed. Some sections of this manual may refer to buttons that are specific to certain types of pool equipment. You'll find more information about those buttons under their corresponding section. If your installation does not include that particular equipment, those sections can be skipped.

-  **Save** - Touch this button to save your selection.
-  **Cancel** - Touch this button to cancel your selection.
-  **Advance** - Touch this button to advance to the next screen.
-  **Back** - Touch this button to return to the previous screen.
-  **Add** - Touch this button to add an item.
-  **Delete** - Touch this button to delete a highlighted item.
-  **Turn On or Enable** - This button will either manually turn on pool equipment or enable a function.
-  **Turn Off or Disable** - This button will either manually turn off pool equipment or disable a function.
-  **Schedule** - Touch this button to schedule a function.
-  **Countdown Timer** - Touch this button to set a countdown timer.
-  **Back** - Touch this button to return to a previous screen.



Body of Water Features and Control Screens

As previously stated, the Body of Water Features Screens allow you to control functions and equipment for a particular Body of Water. Making a change will not affect other Bodies of Water. For example, if the Pool is being displayed when entering the Features Screens, only the pool will be affected by any changes or settings that you make. The contents of the Features Screen is a result of how the OmniPL was configured using the Configuration Wizard. If equipment is missing or does not belong in the Body of Water Features Screen, you may have to go back to the Configuration Wizard and correct the configuration of that equipment.

An example of a Features Screen is shown below. In this example, we are looking at the Pool (shown in lower left of screen). The arrow button on the right means that there are more Features Screens if we advance.

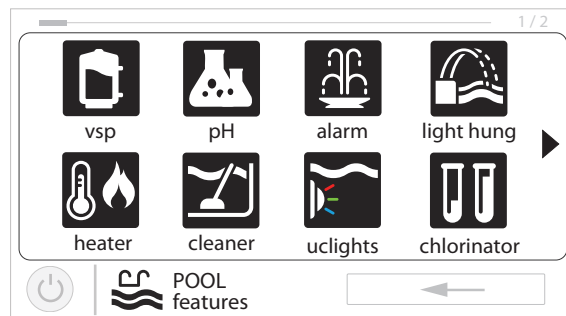

Depending on the equipment that has been configured in your system, your screens will likely be different. The purpose of this section is to explain how Features and Control Screens work as well as show some common equipment examples which will help familiarize you with the interface. Even though some of your equipment may be different, you should see similarities in the following examples that will help you create and change settings for all the equipment in your Features Screens.

The following examples will be shown for the Pool only. All of the equipment shown in the Features Screens have been initially configured in the Configuration Wizard to operate with the Pool. You may have also configured the same type of equipment to operate with a different body of water. For example, you may have a heater for the pool and a second heater for the spa. The following information should help you understand how to control all of your equipment, regardless of which Body of Water is selected.

Control Screens

After an item has been selected in the Features Screen, you'll be brought to a Control Screen. Control Screens are where you will actually make changes to the pool's equipment settings. To change a setting, you'll first select the Body of Water, then select the feature you'd like to change in the Features Screen, then make your change in that feature's Control Screen.

Filter Pump

In the example below, a variable speed pump which was named "vsp" has been configured to be used with the Pool in the Configuration Wizard. Touching the "vsp" button in the Features Screen will bring you to a pump Control Screen which will let you manually turn on/off the pump, set a schedule, set a speed, apply a countdown timer and view the status. Single speed and two speed pumps will have a similar Control Screen.

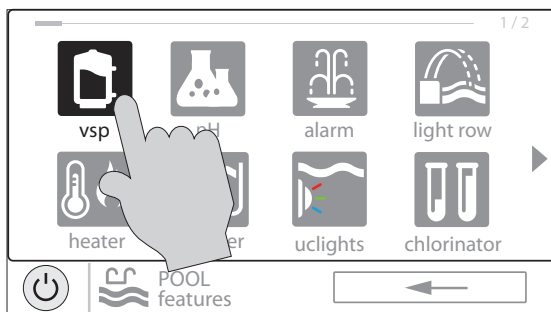

Pool Features Screen

Touching the pump button brings you to the pump control screen.

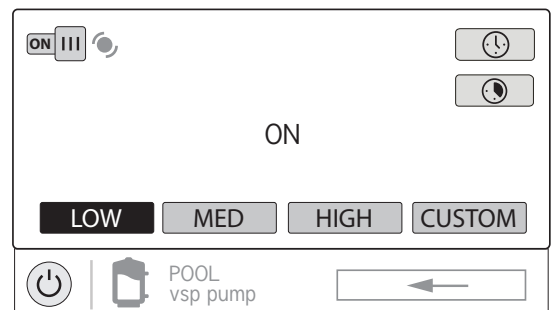

Pump Control Screen

Turn On / Turn Off - Slide this switch manually to turn on/off the pump. This will override schedules or timer settings.

Status of Equipment - This is an indicator only. When lit up and in motion (shown below), the equipment is active. When grayed out and stationary, equipment is off.

Set Schedule - Touch this button to add/delete a schedule for the filter pump or to enable/disable an existing schedule.

Change Speed- Manually select the desired speed. This will not be shown for single speed pumps. Low, Med, and High are fixed speeds. The Custom button will bring you to a screen that allows you to select a speed based on percentage or RPM (determined during configuration).

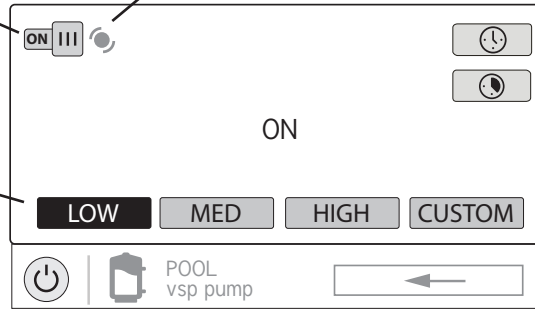

Countdown Timer - Touch this button to set a countdown timer for the filter pump.

Add a Schedule

If the "Set Schedule" button is touched, you'll be brought to the pump schedule screen below. Here you can add, delete, edit, enable and disable schedules. Because there have been no schedules set up, the screen is blank. Touch the Add button (+) to add a schedule for the pool pump.

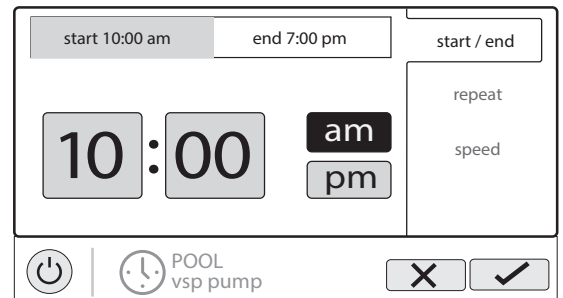
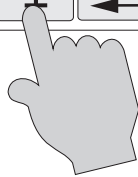
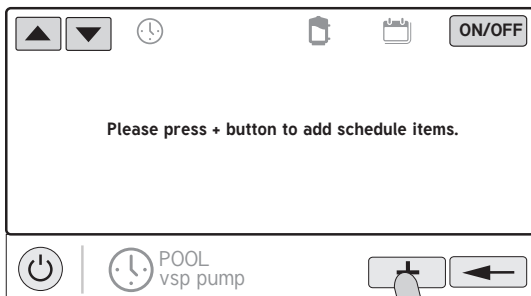

Set Schedule Time

Refer to the screen below to set the start and stop times. When finished, touch "repeat".

Set Start Time- Select this button to edit the start time. The pump will start at the time shown.

Edit Time- Use these buttons to change desired time.

Select Field- Touch Hours, Minutes or AM/PM to edit.

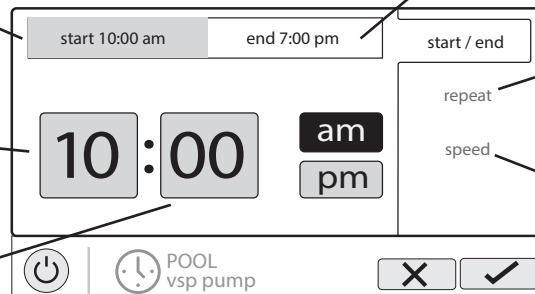

Set End Time - Select this button to edit the end time. The pump cycle will end at the time shown.

Set Schedule Frequency - Select how often you'd like the schedule to run (weekdays, weekends, all week or custom).

Set Pump Speed - Select this button to change the pump speed for the schedule.



Set Schedule Frequency

Refer to the screen below to select how often you'd like the schedule to run. If "custom" is selected, you'll be asked which day(s) of the week you would like the pump to run. Touch "speed" when finished.

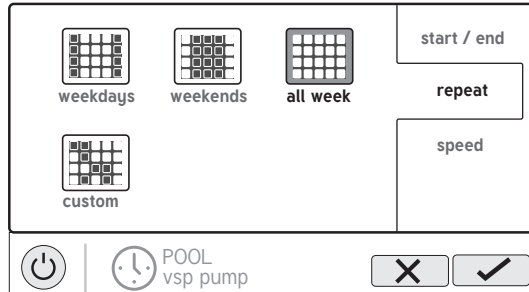

Set Pump Speed

Refer to the screen below to select the pump speed during the schedule. If custom is selected, you'll be asked to set the % pump speed or RPM depending on the setting. When finished, touch the Save button to save the schedule.

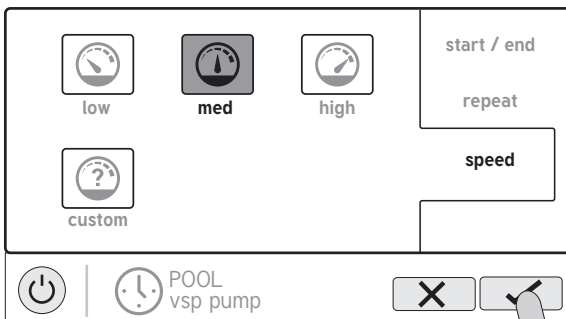

After saving, you'll be brought back to the pump schedule screen. The new schedule will be displayed.

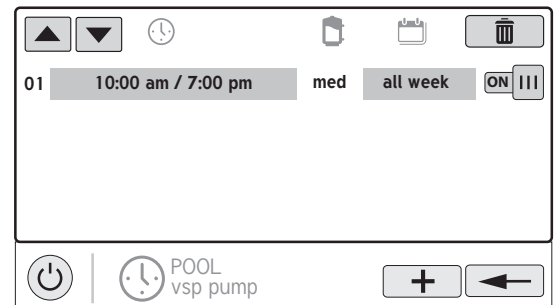

NOTE: If you intend to run the pump at different speeds throughout the day, create additional schedules. You can start a new schedule on the same minute that the previous one ends. If schedules overlap, the newest schedule's start time will take priority by ending the previous schedule early. You can create up to 20 schedules per device.

Edit a Schedule

To edit a schedule, touch the schedule as shown below. You'll be brought back to the screen which will allow you to set times, speed and frequency.

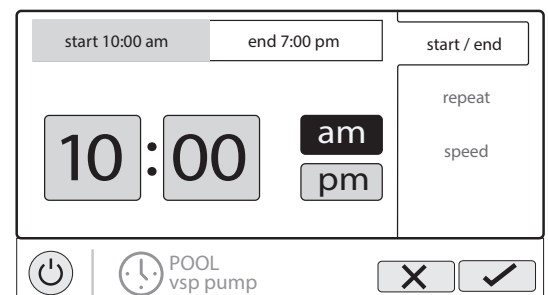
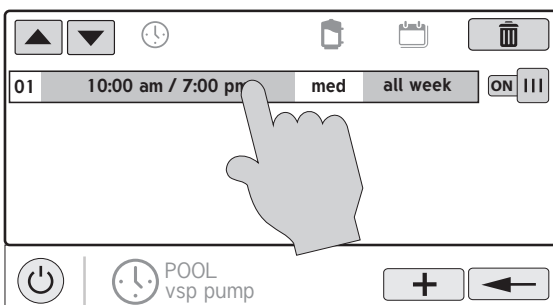

Turning a Schedule Off

There may be circumstances when you will want to turn off a schedule temporarily. To do this, slide the On/Off button to "Off". The schedule will remain off until you go back to this screen and turn it on.

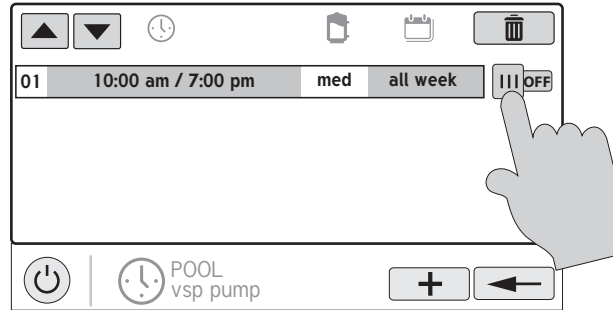

Deleting a Schedule

Schedules can be deleted when they are no longer necessary. To delete a schedule, select the schedule and touch Delete as shown below. A Delete button should appear on the side of the schedule. Touch this Delete button to remove the schedule.

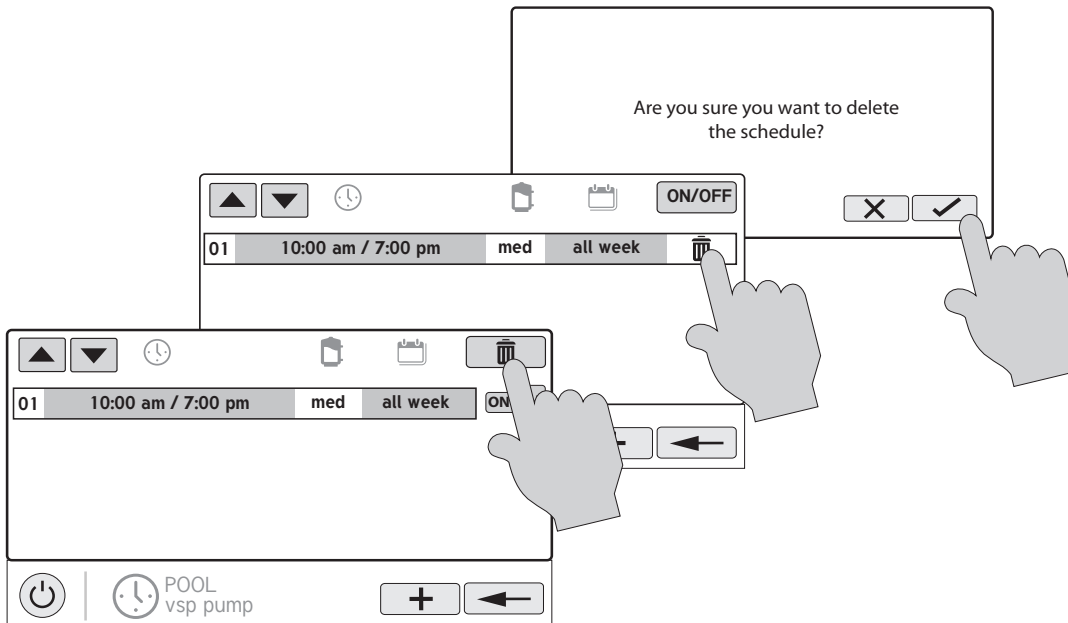

Countdown Timer

A Countdown timer runs or enables equipment for the amount of time specified. You can initiate the Countdown timer at the equipment's control screen. At the countdown screen, set the desired countdown time. In this case, the timer will run the pump for the specified countdown time. If the equipment is already running due to a schedule, the countdown timer setting will override the schedule and turn off at the end of the countdown interval. If the equipment is off, the countdown timer will turn it on for the duration/speed that has been set.

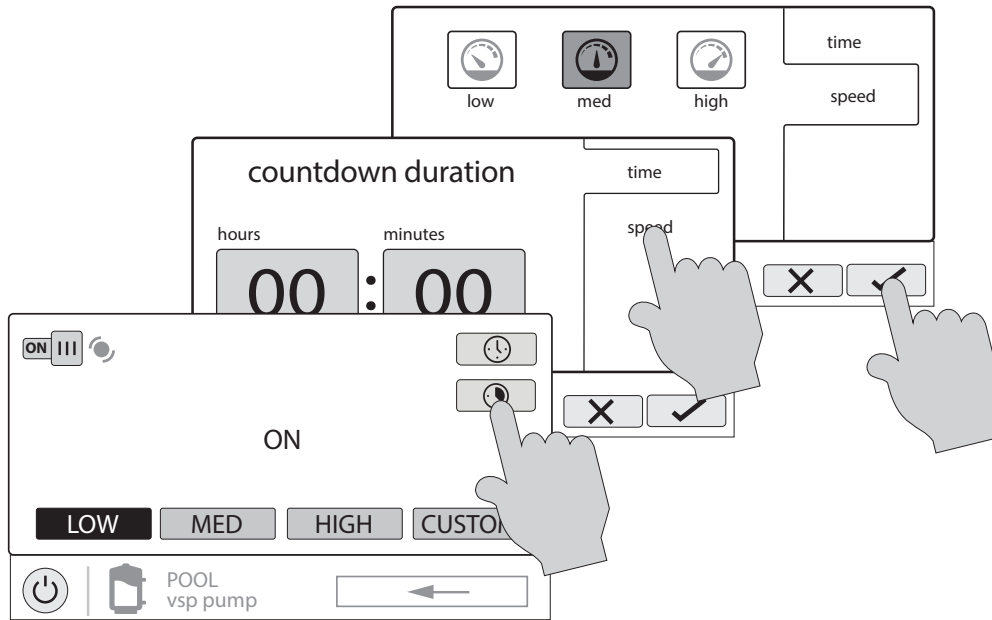

Heater

Touching the Heater button in the Features Screen will let you enable/disable heaters, set priority, set temperature, set a schedule and view the status of the heater for the selected Body of Water. An example of the heater Control Screen is shown below:

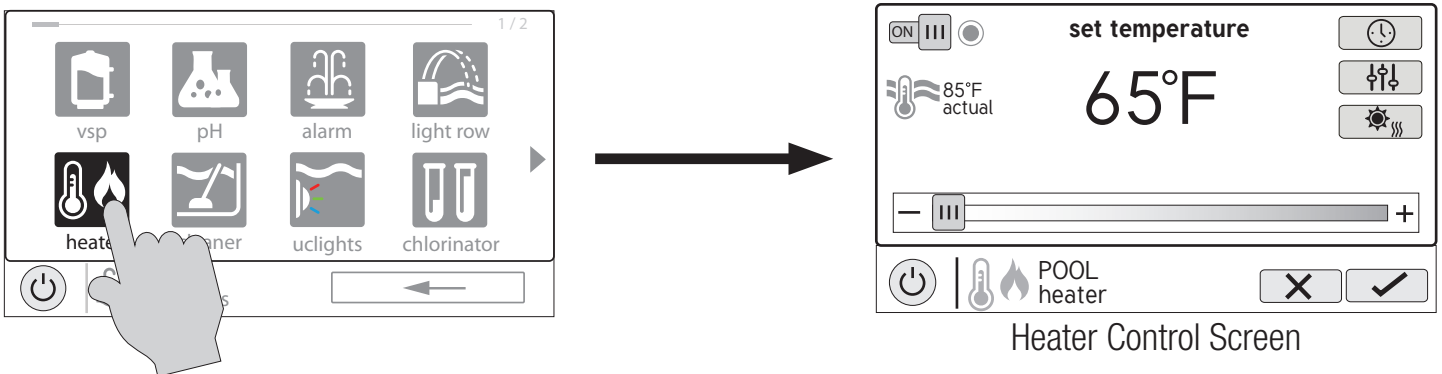

Enable / Disable - Slide this switch to enable and disable the heater. The setting will not take effect until the Save button is touched. To turn on the heater, adjust the setpoint higher than the actual Body of Water temperature and then Save.

Change Setting - This slider will raise and lower the heater setpoint setting.

Status of Equipment - When grayed out and stationary, equipment is currently idle. When in motion, the heater is actively heating.

Set Schedule - Touch this button to set a schedule for the heater.

Set Priority - If more than one heater is configured for the Body of Water, use this button to set priority and enable/disable physical heaters.

Solar Heater Shortcut - If solar heating is configured, this button allows you to view/change setpoint of the solar heater.

Save Setting - Setting is not saved until this button is pushed.

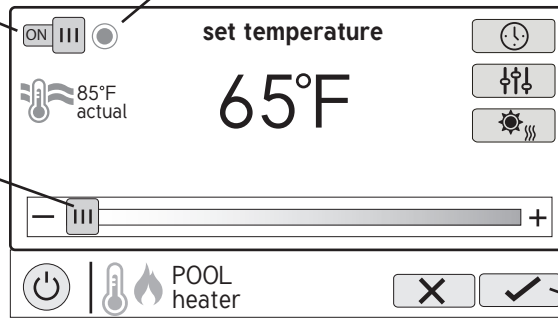

Setting and Changing Priority

If there is more than one heater configured for the body of water, the Set Priority button will appear in the Heater Control Screen. If the Priority heater can not meet the demand for heat, the next heater will be allowed to operate. Use Priority to maximize efficiency by allowing the most cost effective heater(s) to run first.

The example below shows how to change priority to run the heat pump first, then, if it can't meet the demand for heat, the gas heater will be allowed to operate. Note that the time interval used for heater priority can only be changed in the Configuration Wizard. Note that a time interval setting of "0" will eliminate priority and always run both heaters at the same time.

Enable and Disable Heaters - When "Select Source" is highlighted, touching a heater button will enable and disable that heater. A grayed out heater is disabled.

Operation Indicator - This symbol indicates that the heater is currently running.

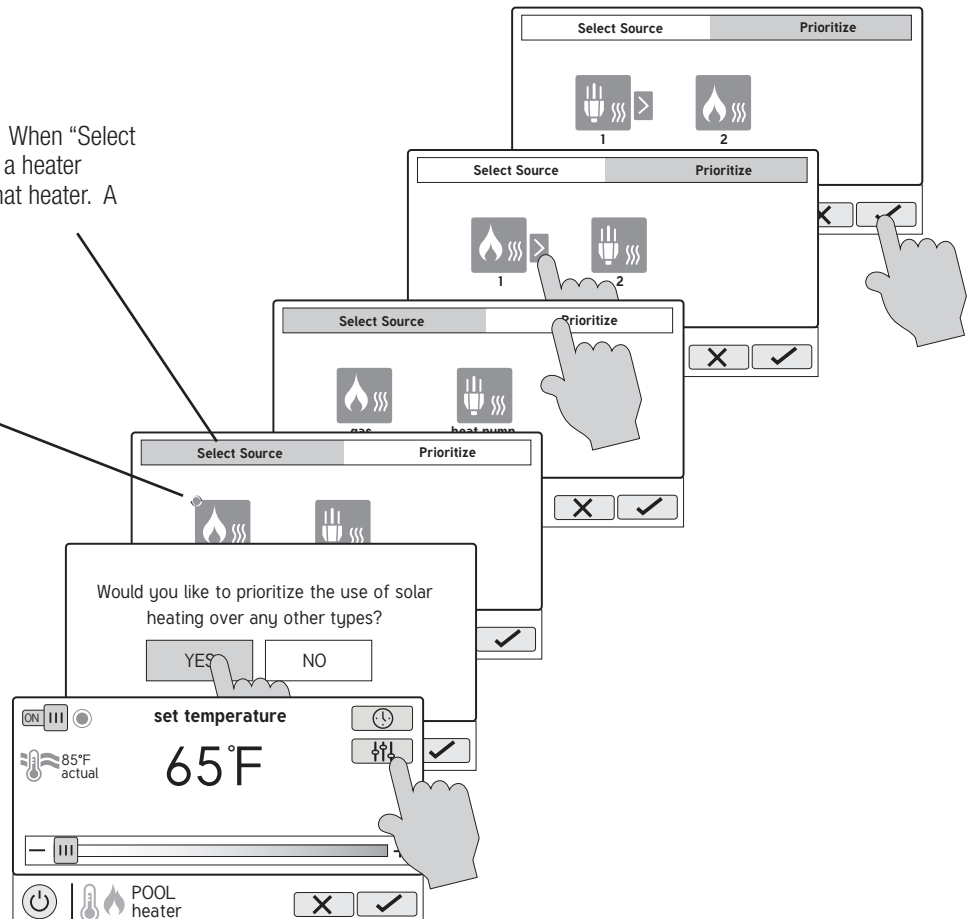

Chlorinator

If a chlorinator has been configured in the Configuration Wizard, you will see it in the Features Screen. Touching the chlorinator button will bring you to the Chlorinator Control Screen that will allow you to enable/disable the chlorinator, set a schedule, super chlorinate and view/change diagnostics. A sample screen is shown below. For schedules, refer to the previous examples in this manual.

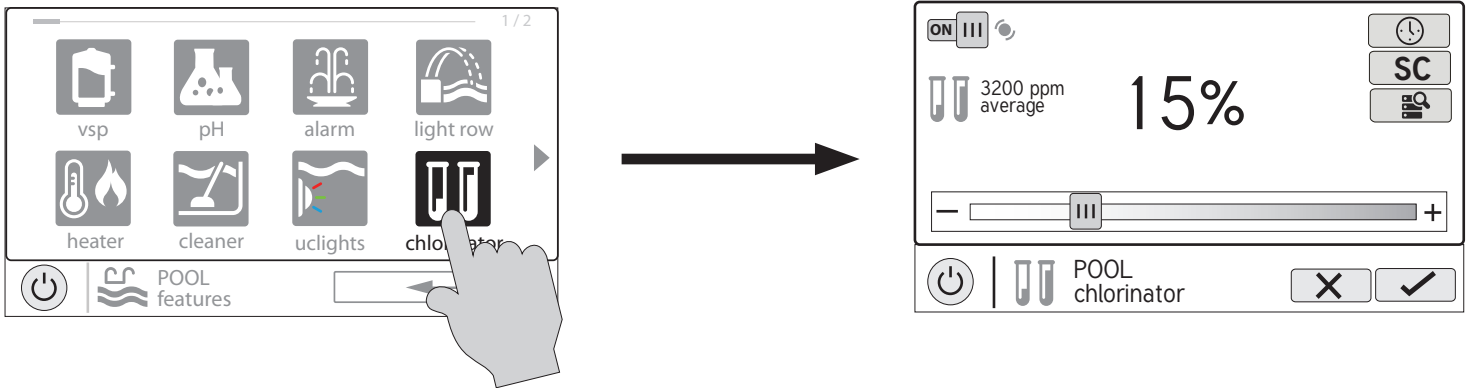

Enable / Disable - Slide this switch to enable and disable the chlorinator and then touch the Save button.

Change Setting- This slider will raise and lower the chlorinator setpoint setting. If an HL-CHEM is used and ORP is enabled, the adjustment will be displayed in “mV”.

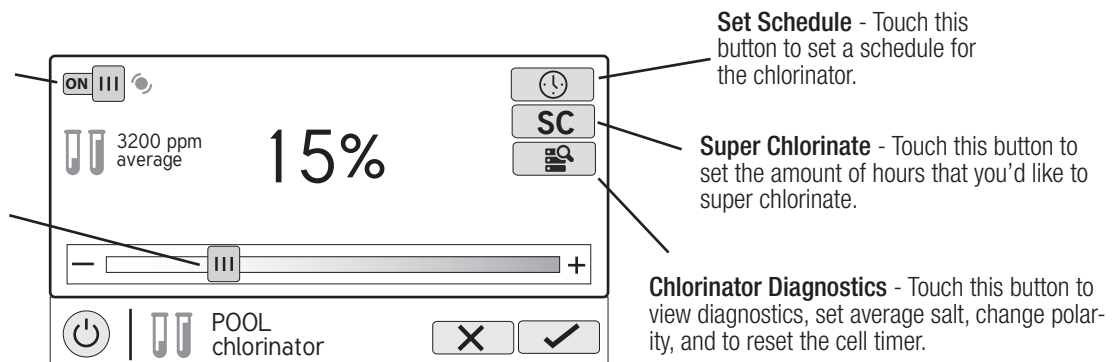

Chlorinator Control Screen

If using an HL-CHEM - The Hayward HL-CHEM Sense and Dispense accessory continuously tests the pool’s sanitization and pH levels allowing the OmniPL to automatically generate the correct amount of chlorine and dispense the proper amount of pH reducer. If using the HL-CHEM and ORP has been enabled in the Configuration Wizard, the OmniPL will display chlorinator readings and settings in “mV” rather than “%”. Refer to the information below as well as the HL-CHEM manual for configuration and operation instructions.

Chlorinator Setting - The OmniPL can only generate chlorine while the filter pump is operating. Set the percentage of run time that you desire chlorine generation. Raise this value to generate more chlorine. Lower this value to generate less.

NOTE: After the initial setting, you may need to raise the setting when the pool water temperature increases significantly, when there is higher than normal bather load or when your chlorinator cell ages. You may need to lower the setting when the pool water temperature decreases significantly or there are long periods of inactivity.

Super Chlorinate - When you have an unusually high bather load, a large amount of rain, a cloudy water condition, or any other condition that requires a large amount of chlorine to be introduced to the pool, activate the OmniPL Super Chlorinate function. The OmniPL will turn on the filter pump (if not scheduled), set the pool/spa valves to the correct position, and set the chlorine generator to maximum output. The super chlorinate function will continue for the programmed number of hours overriding the normal filter pump schedule settings. At the end of the super chlorinate period, the pool will return to normal operation. If you manually turn off the filter pump, the super chlorinate function terminates.

Chlorinator Diagnostics

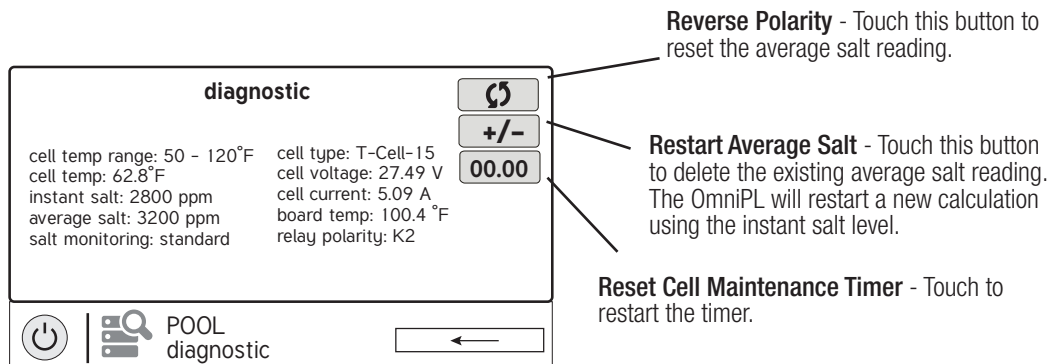
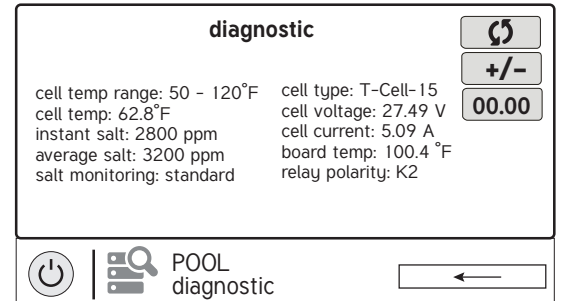
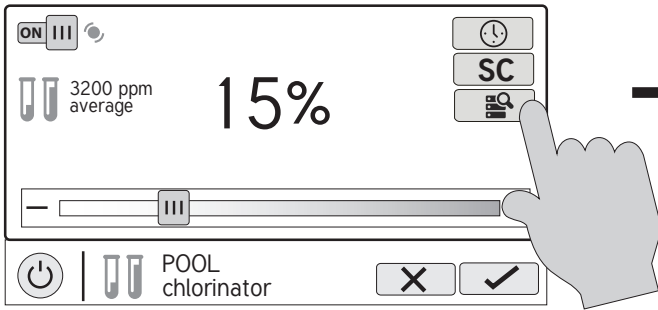

For the chlorinator to be operating, several conditions must exist: the filter pump must be running, the flow switch must detect flow, the chlorinator setting must be greater than 0%, the water temperature at the cell must be between 50°F and 140°F (superchlorinate will run under 50° except during freeze protection), and the salt level must be within the operating range. If any of these conditions are not met, the diagnostic screen will show that the chlorinator is off. Also, depending on the chlorinator setting, the OmniPL may be in between cycles and the chlorinator is at rest (cell current shows 0.00A). To force the start of the new cycle, you can touch the Reverse Polarity button.

NOTE: If a conventional or solar heater is operating, it is likely that the temperature of the water at the cell is higher than the pool/spa water temperature displayed on the OmniPL default display.

Restart Average Salt - The OmniPL monitors salt level while chlorinating. At any time, go to the chlorinator diagnostic screen to view the average salt based on an ongoing calculated average. If you restart average salt, the previous average is deleted and the OmniPL begins calculating the new average from that moment. The OmniPL will start with the instant salt reading and calculate an ongoing average.

Reverse Polarity - The OmniPL periodically reverses the polarity of the voltage applied to the chlorinator cell in order to automatically clean off any calcium deposits. To check operation in both polarities, touch this button. The chlorinator will turn off, wait for 15 seconds and then turn on in the opposite polarity.

Reset Cell Maintenance Timer - To maintain maximum performance, it is recommended that you open and visually inspect the chlorinator cell every 3 months or after cleaning your filter. The OmniPL will remind you to do this by displaying a message to clean and inspect the cell after approximately 500 hours of operation. You can restart the timer by touching this button.



pH Dispense

If using an HL-CHEM: The Hayward HL-CHEM Sense and Dispense accessory continuously tests the pool's sanitization and pH levels allowing the OmniPL to automatically generate the correct amount of chlorine and dispense the proper amount of pH reducer. Refer to the information below as well as the HL-CHEM manual for configuration and operation instructions.

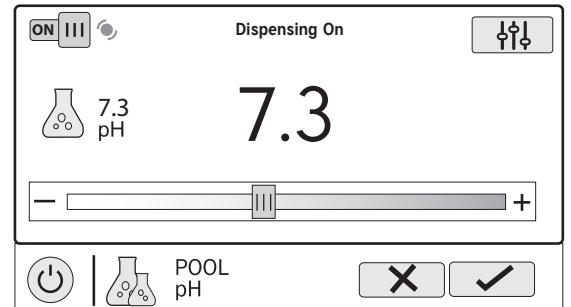
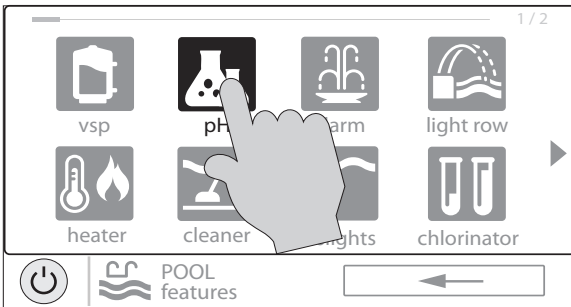

pH Dispense Control Screen

Enable / Disable - Slide this switch to enable and disable the pH dispenser and then touch the Save button.

Set pH Level - Set the desired pH level.

Calibrate - Calibrate the pH reading if the OmniPL doesn't display the correct level.

Current pH Level - Shows the current pH reading in the pool or spa.

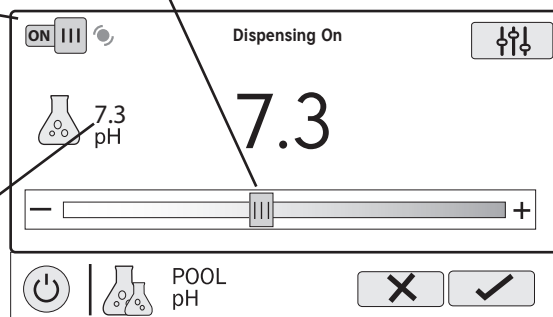

pH Calibration

If the OmniPL pH reading differs from independent water tests, you can adjust the reading by touching the Calibrate button and using procedure below. You'll be asked for the difference between the displayed pH level and the true pH level. You'll want to select the amount needed to go from the displayed level to the true level. In the example below, the displayed level is 7.3 and the true level is 7.5. You need to add .2 to the displayed level to arrive at the true pH level.

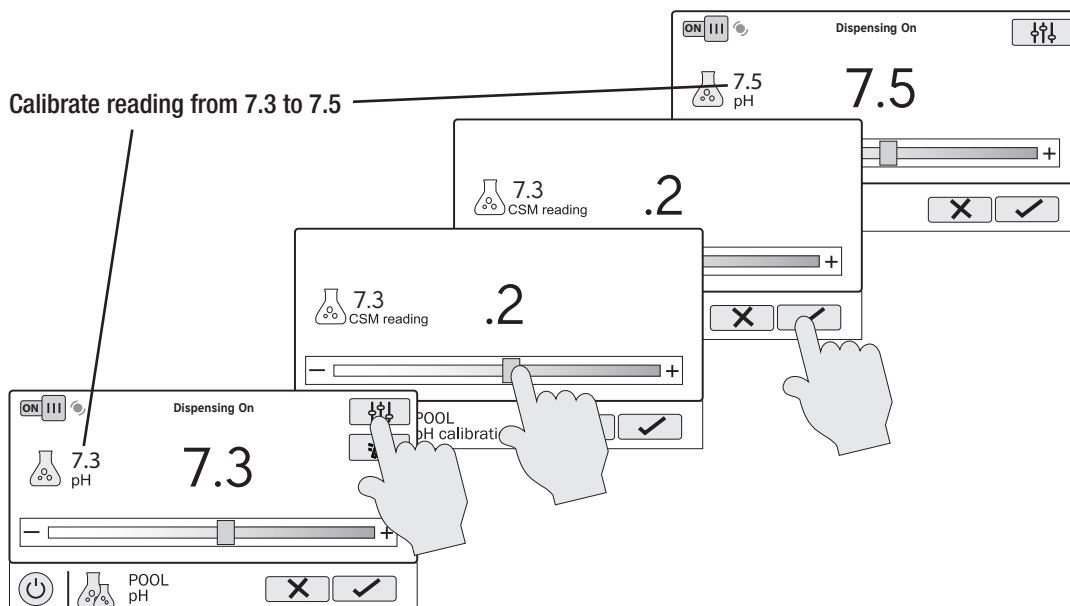

Calibrate reading from 7.3 to 7.5

ColorLogic Lights

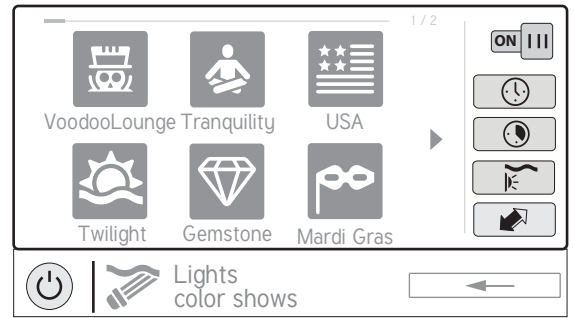
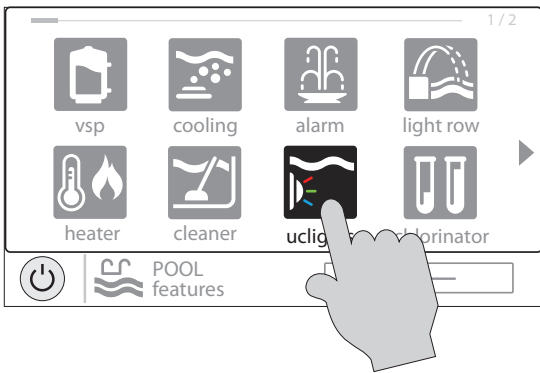

ColorLogic Control Screen

Selections - select the desired light show or solid color.

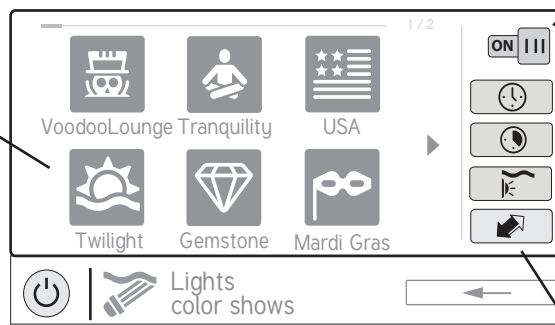

Turn On / Turn Off - Slide this switch to manually turn on/off the ColorLogic lights. This will override schedules or timer settings.

Set Schedule - Touch this button to set a schedule for the ColorLogic lights.

Countdown Timer - Touch this button to set a countdown timer for the lights.

Light Show/Color - This button will change the selection between light shows (🔄) and solid colors (🎨).

Synchronize - Touch this button to synchronize the ColorLogic lights. The ColorLogic lights will then default to Voodoo Lounge.

You can set schedules for the ColorLogic light as well as a countdown timer. This procedure has been shown previously. Note that after the countdown interval, the lights will go off regardless of their previous state.

Light Show/Color - From the ColorLogic Control Screen, select the desired show or color. Use the Advance button to show all of the available selections. Use the Light Show/Color button to switch between all light shows and all solid colors.

Synchronize - Because changing colors and shows requires interrupting power to the ColorLogic lights, there is a chance that the lights could lose synchronization due to timing issues. If you find that the color or show does not correspond with the selection that you've made, the lights may be out of sync. Touch the Synchronize button to re-sync the ColorLogic lights.

OmniPL Direct Mode (Universal ColorLogic Lights built after June 2018)

Universal ColorLogic lights built after June 2018 are capable of OmniPL Direct mode. To run in this mode, select OmniPL Direct mode when configuring your lights in the Configuration Wizard (see Installation Manual). The OmniPL will test your lights during configuration to confirm that they support OmniPL Direct mode. If so, the ColorLogic Control Screen will display a Settings icon rather than a Synchronize button, which allows both Speed and Brightness control shown on the diagram below. Note that Settings will also be an option when setting up schedules and timers for lights running in OmniPL Direct mode. Refer to your Universal ColorLogic manual for more information about OmniPL Direct mode.

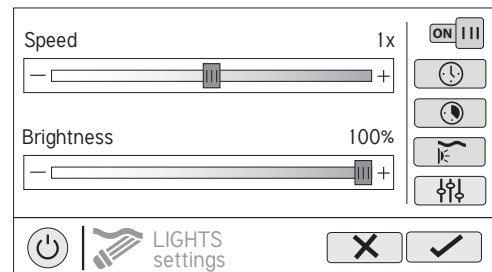
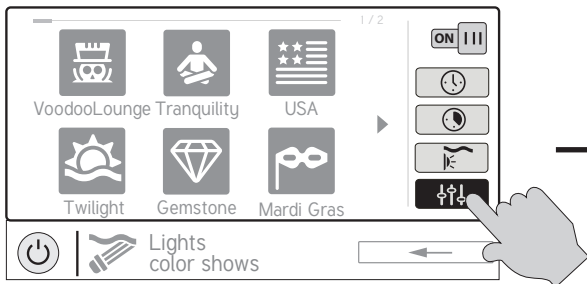

Other Lights

You can turn other lights on/off, set schedules, and set a countdown timer at the Other Lights Control Screen shown above. These functions have been illustrated previously in this manual.

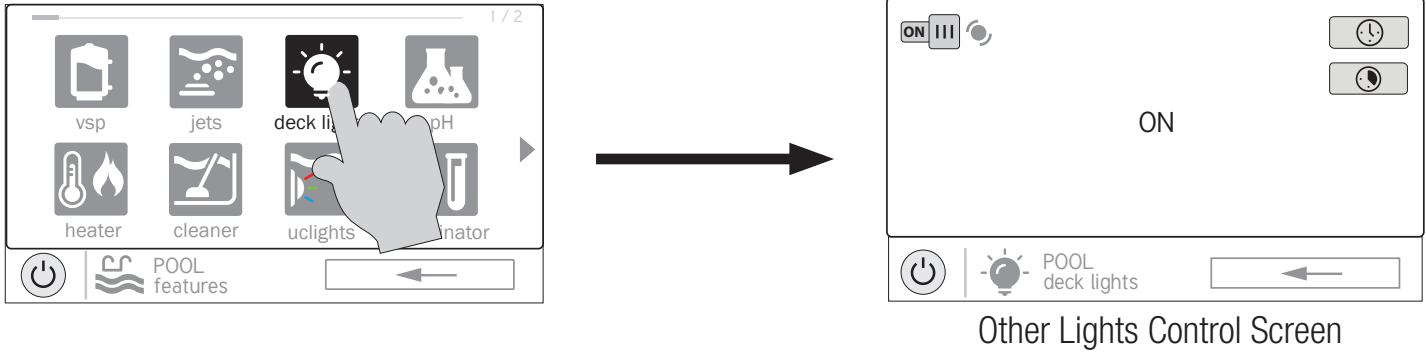

Cleaners

You can turn the cleaner on/off, set schedules, and set a countdown timer at the Cleaners Control Screen shown below. You can also set pump speed if a two-speed or variable speed pump has been configured to be used with the cleaner. These functions have been illustrated previously in this manual.

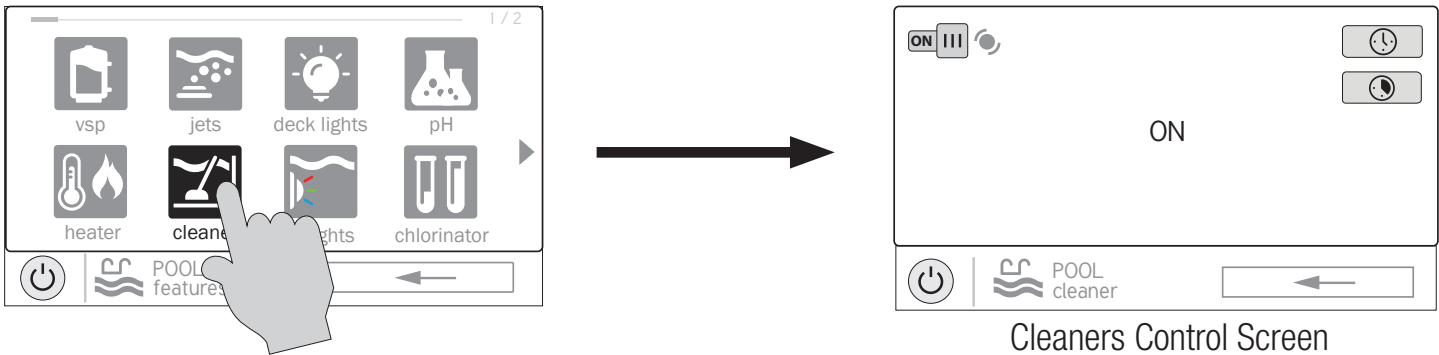

Water Features

You can turn the water feature on/off, set schedules, and set a countdown timer at the Water Features Control Screen shown below. You can also set pump speed if a two-speed or variable speed pump has been configured to be used with the water feature. These functions have been illustrated previously in this manual.

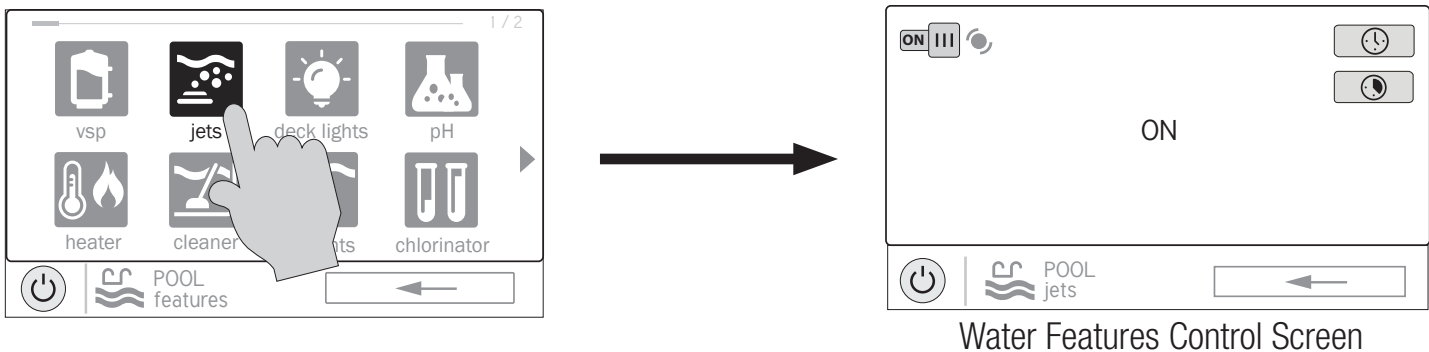

Accessories

You can turn the accessories on/off, set schedules, and set a countdown timers at the Accessories Control Screen shown below. You can also set pump speed if a two-speed or variable speed pump has been configured to be used with the accessory. These functions have been illustrated previously in this manual.

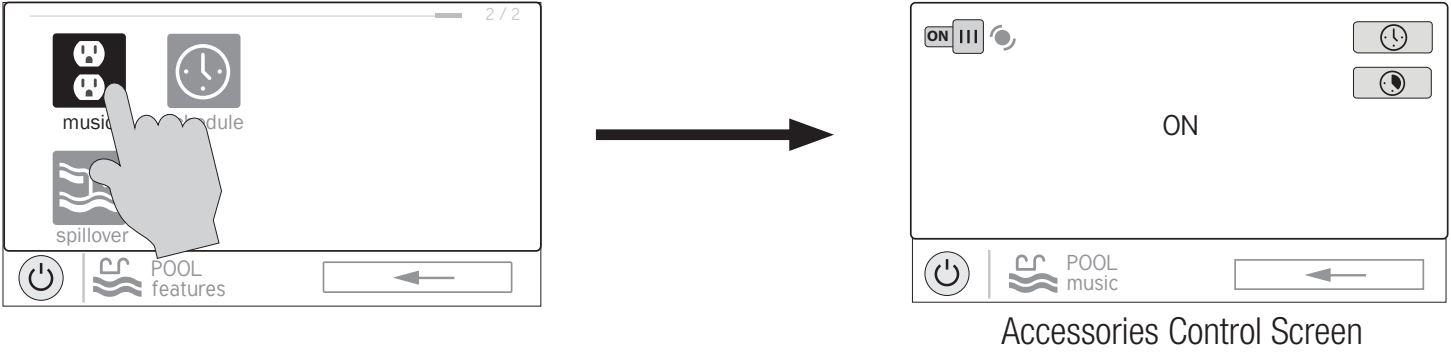

Schedule

The Schedule button appears in the Features Screen for all Bodies of Water regardless of what equipment has been configured in the Configuration Wizard. It offers a convenient way to create and edit schedules. Any equipment that has been configured for this Body of Water, and has an option for schedules, will be shown in the Schedule Control Screen. Equipment that has been assigned a schedule will show a clock symbol in the upper right side of the button. Touching any of these buttons will bring you to the schedule screen for that equipment. Create and edit schedules as shown on page 5.

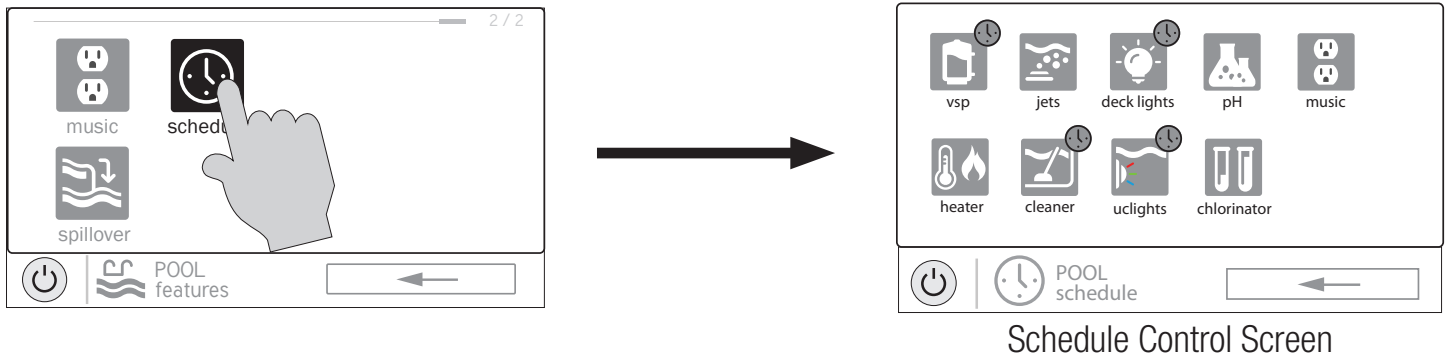

Spillover

If spillover is configured, you can turn spillover on/off, set schedules, and set a countdown timer at the Spillover Control Screen. These functions have been illustrated previously in this manual.

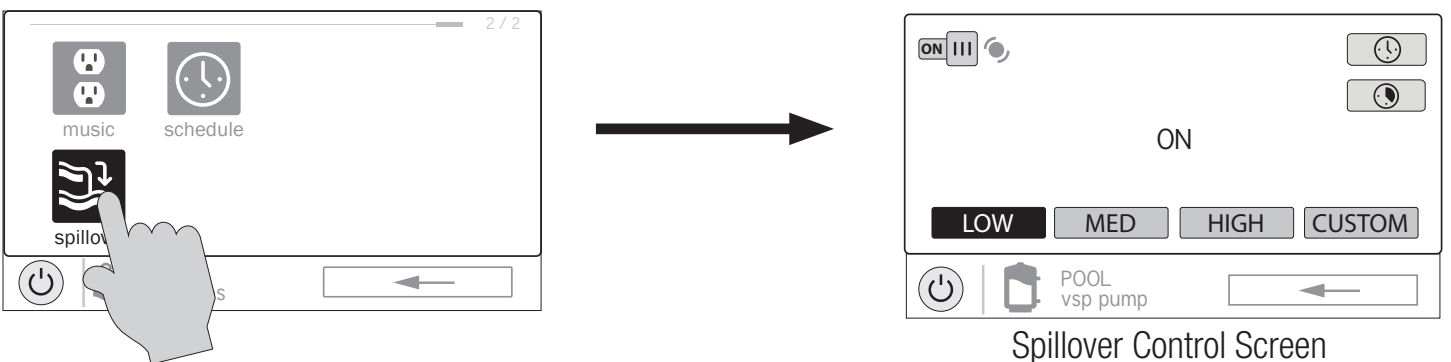

Freeze Protect Override

If freeze protection is enabled AND the air temperature falls below the freeze threshold, the OmniPL will turn on the filter pump to circulate the water. If two bodies of water are configured, the valves will also alternate between the pool and spa every 30 minutes and the filter pump will turn off while the valves are turning. The chlorinator will not operate if freeze protection is the only reason the pump is running. Freeze protection can be overridden for 60 minutes by touching the Freeze Prot. button found in the Features Screen for the Body of Water with the highest heating priority (see below). **IMPORTANT:** Ensure that equipment is protected from a freeze condition before overriding this feature. To resume normal freeze protection, simply touch the Freeze Prot. button again.

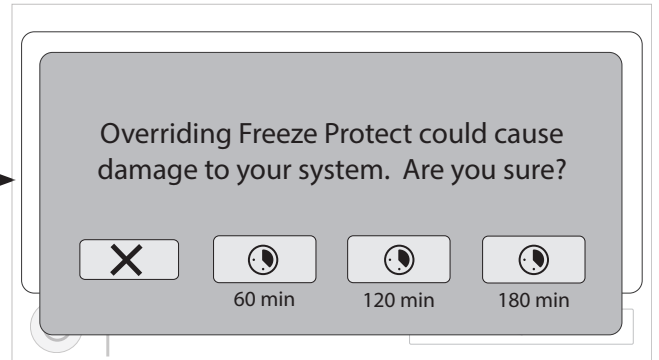
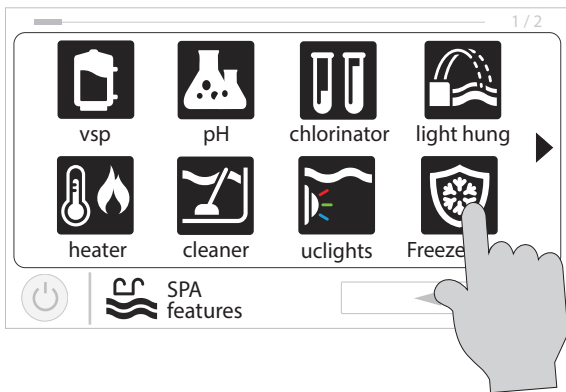

Favorites

Favorites can be found on the right side of the Home Screen and offer control for equipment regardless of which Body of Water is being displayed. Favorites are also used to control equipment that has been configured for the "Backyard". Favorites offer quick easy access to frequently used functions and most Favorites can be added to Simple Mode (page 2).

The OmniPL will automatically create some Favorites based on your system's configuration. You can also create your own Favorites. Once Favorites have been created, you can change the location in which they appear on the Home Screen. In addition, if you no longer require a Favorite, it can be deleted. The OmniPL supports up to a total of 50 Favorites.

In most cases, touching a Favorite button on the Home Screen will bring you to the same screens that have been covered in the Control Screens section of this manual. Refer to these screens if necessary.

Alarms

An alarm condition will change the mood color of the entire touchscreen and display a "!" symbol in the upper right side of the associated button as shown:



For more detail, use the Alarm button found in Favorites. Alarms are automatically generated when new firmware upgrades are available (requires firmware version 4.0.0 or later) or if the OmniPL detects a condition that is outside of the normal operating parameters. The Alarm button found in Favorites will bring you to a screen that displays any active alarms. Some alarms can be manually deleted; others will remain until the alarm condition is corrected.

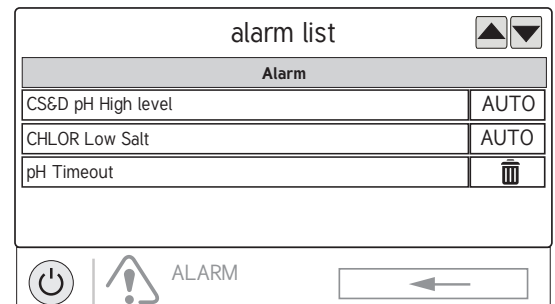
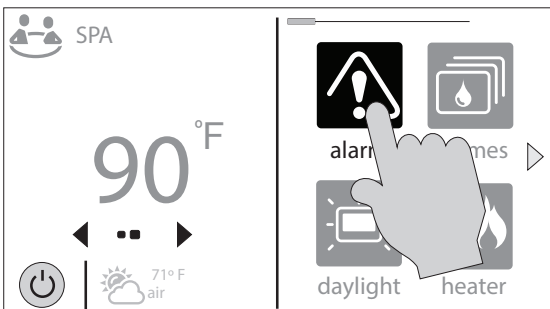

Home Screen



Deleting Alarms

For Alarms that can be manually deleted, follow the procedure below.

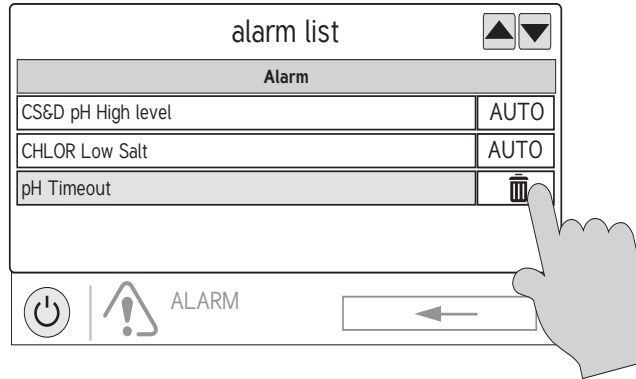

Upgrading Firmware (Omni products using firmware 4.0.0 or greater)

All firmware upgrades are initiated from Service Mode. If you receive an alarm that upgrades are available, selecting the alarm will give you the option to delete the alert or start the upgrade (you can also ignore the alert and wait for a more convenient time). If you choose to start the upgrade process, you'll be warned that the OmniPL must go into Service Mode and will temporarily pause operation during this time. The upgrade procedure is shown on page 28 under "Upgrade from Internet".

Daylight

Daylight is another button that will appear in Favorites by default. This button is used to change the screen contrast for better viewing in bright sunshine. Touching this button will toggle Daylight viewing on and off.

Features/Lights/Heaters/Backyard

These four buttons function similarly. If any water feature, light, heater or backyard accessory has been configured in the Configuration Wizard, a Features, Lights, Heaters and/or Backyard button will appear in Favorites. These buttons give you quick access to the Control Screens for all related pool equipment. These are the same Control Screens that you've used in the Body of Water Features and Controls Screen section of this manual. For Features, Lights and Heaters you can display the equipment based on a particular Body of Water or from all Bodies of Water as shown below.

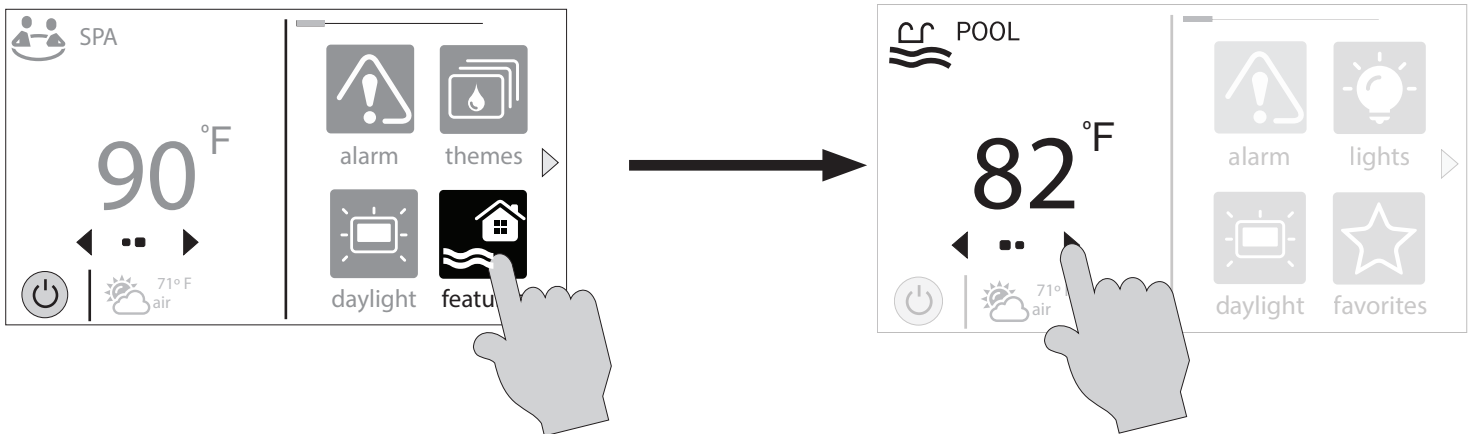

Edit Features/Lights/Heaters

When a feature, light or backyard accessory is selected, you'll advance to the related Control Screen.

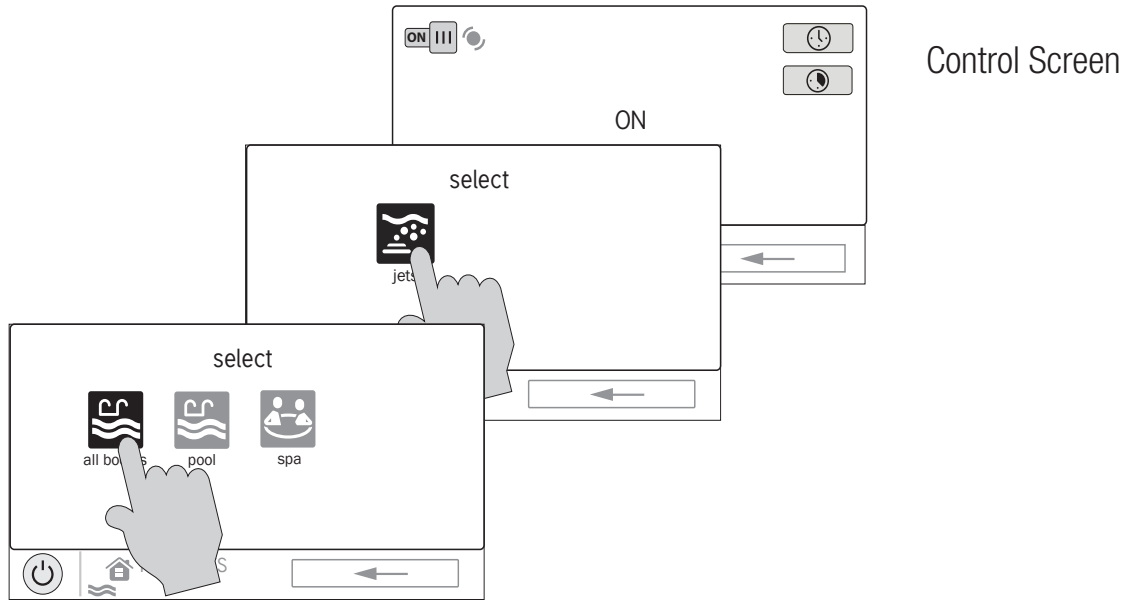

Favorites Screen

All of the buttons on the right side of the Home Screen are referred to as "Favorites" but there is also a Favorites button. Using this button, you can create and manage all of your Favorites.

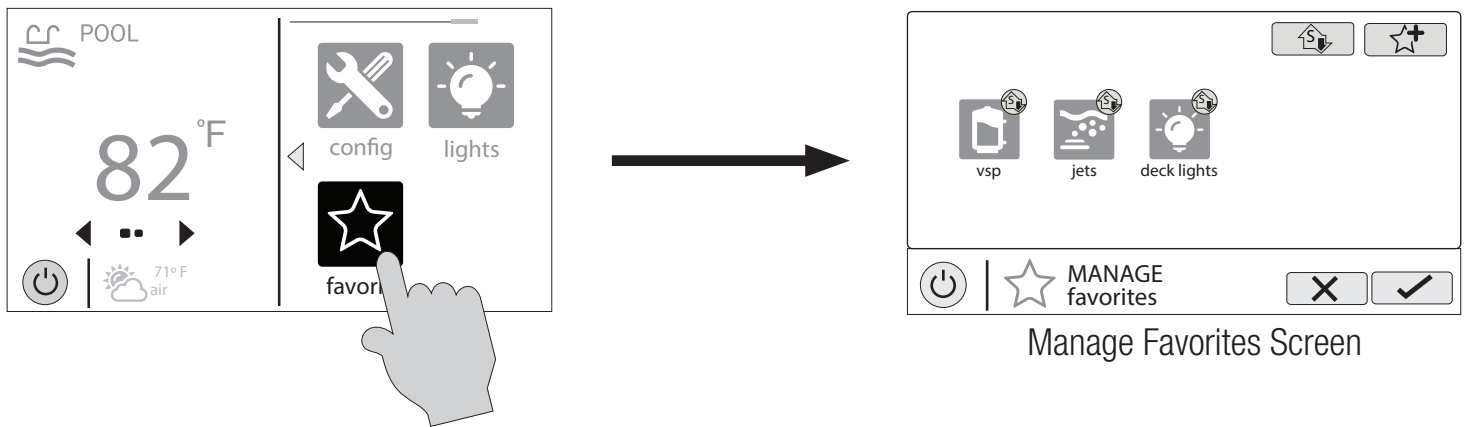

Current Favorites - These are favorites that have already been added. You can change the location of where they appear on the Home Screen.

Add to Simple Mode - Touch this button to add a favorite to Simple Mode.

Add Favorite - Touch this button to add a favorite. NOTE: If a Spa Side remote control is configured, you'll have the option to assign the Favorite to one of its buttons.

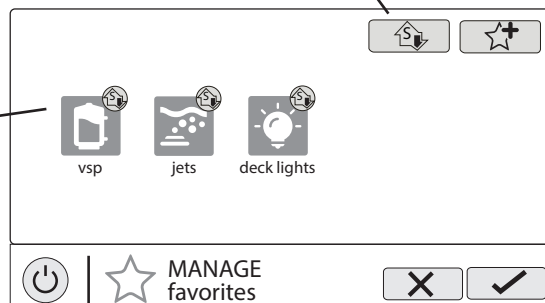

Creating Favorites

Follow the procedure below for adding Favorites. This example shows how to create a Favorite for equipment that was configured as a Backyard Accessory. In this case, "Music". To find "Music" in our Add Favorites screen, we have to select "Backyard" when prompted. The next screen will show all equipment configured for the Backyard; in this case, just Music. Selecting Music and saving will add Music to the Favorites screen. We can now move the Music button if desired.

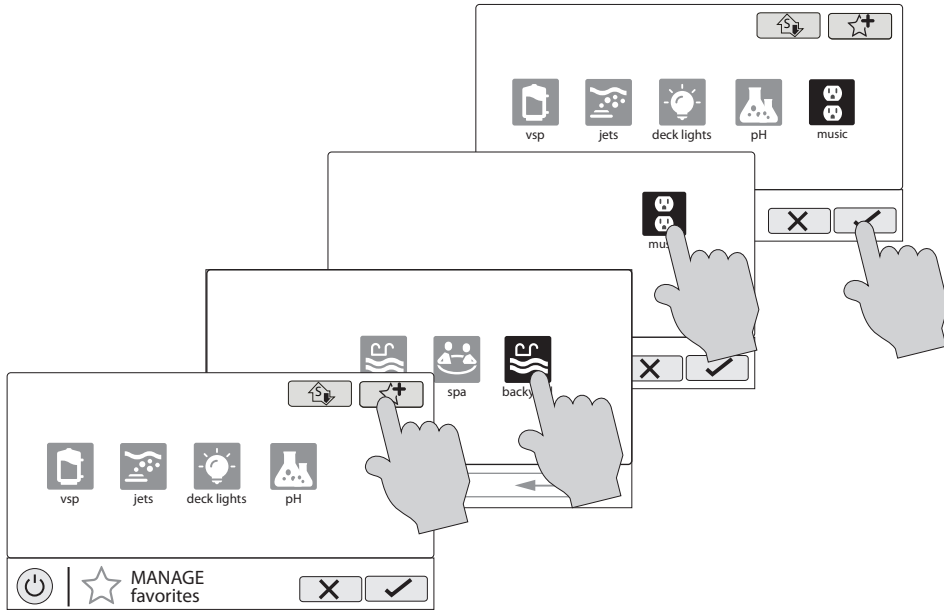

Moving Favorites

Favorites will be displayed on the Home Screen in the order that they are shown on the Favorites Screen, from left to right. The default Favorites can not be moved. To move Favorites, follow the procedure below.

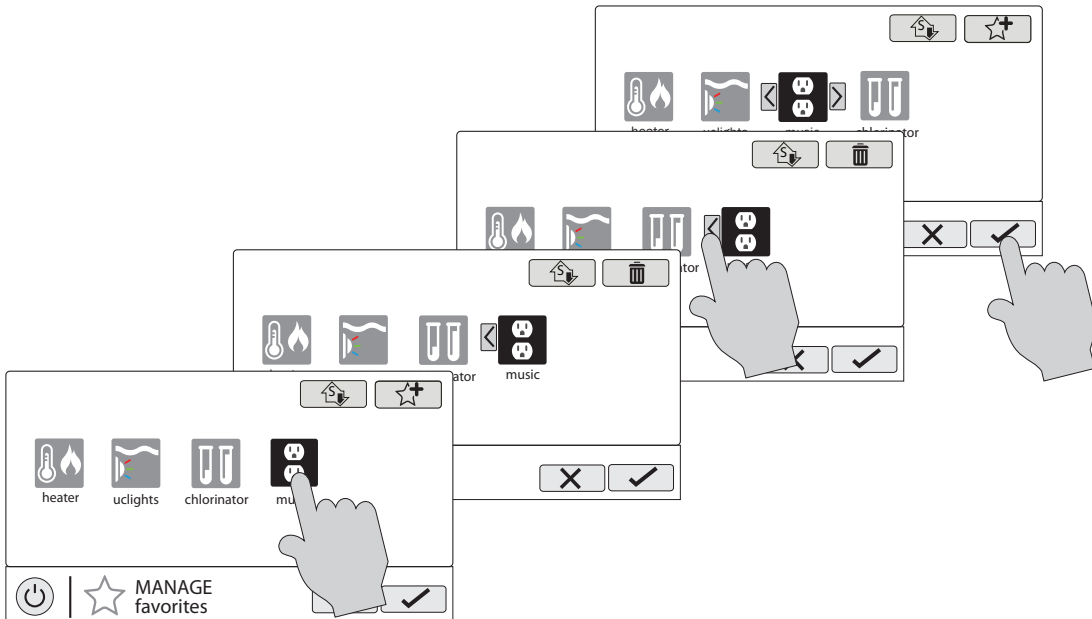

Deleting Favorites

To delete Favorites, follow the procedure below. Default Favorites can not be deleted.

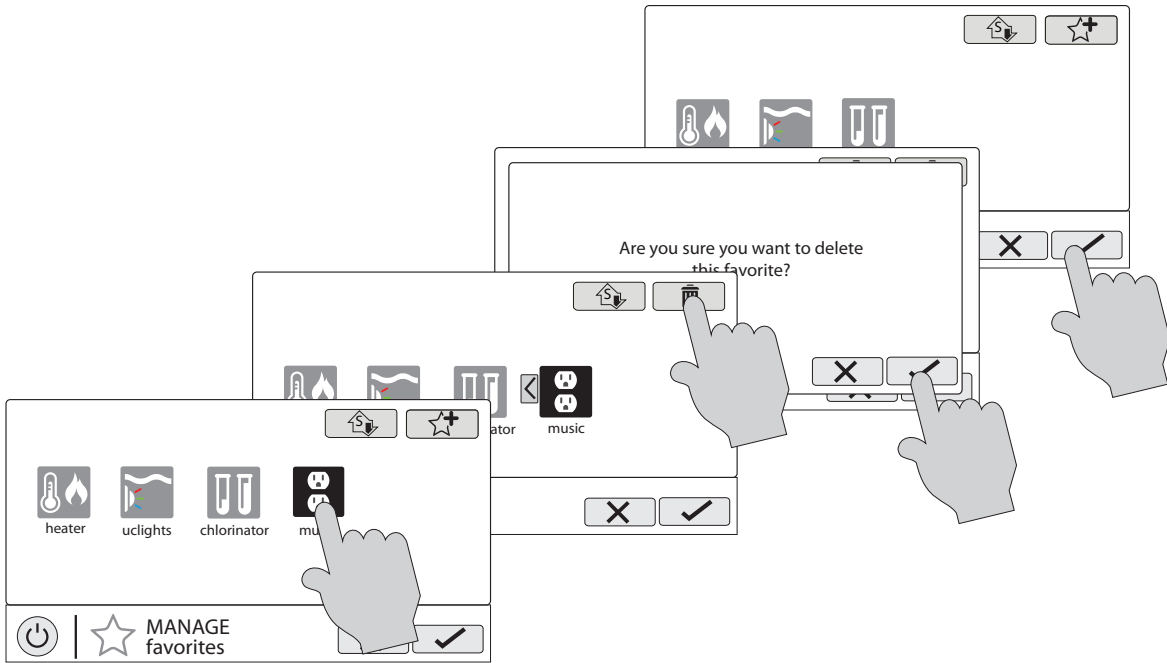

Changing the Name of Favorite

You can easily change the name of a Favorite. While in the Manage Favorites screen, select the Favorite you'd like to change. Now select the name of the Favorite shown underneath the icon. A keyboard should appear and allow you to change the name. Select the Save button when finished.

Adding Favorites to Simple Mode

For more information on Simple Mode, refer to page 30. Note that most Favorites can be added to Simple Mode but not all. Follow the procedure below. Note: If the Favorite has been added to Simple Mode, moving the button location on the Favorites screen will affect its position on the Simple Mode screen.

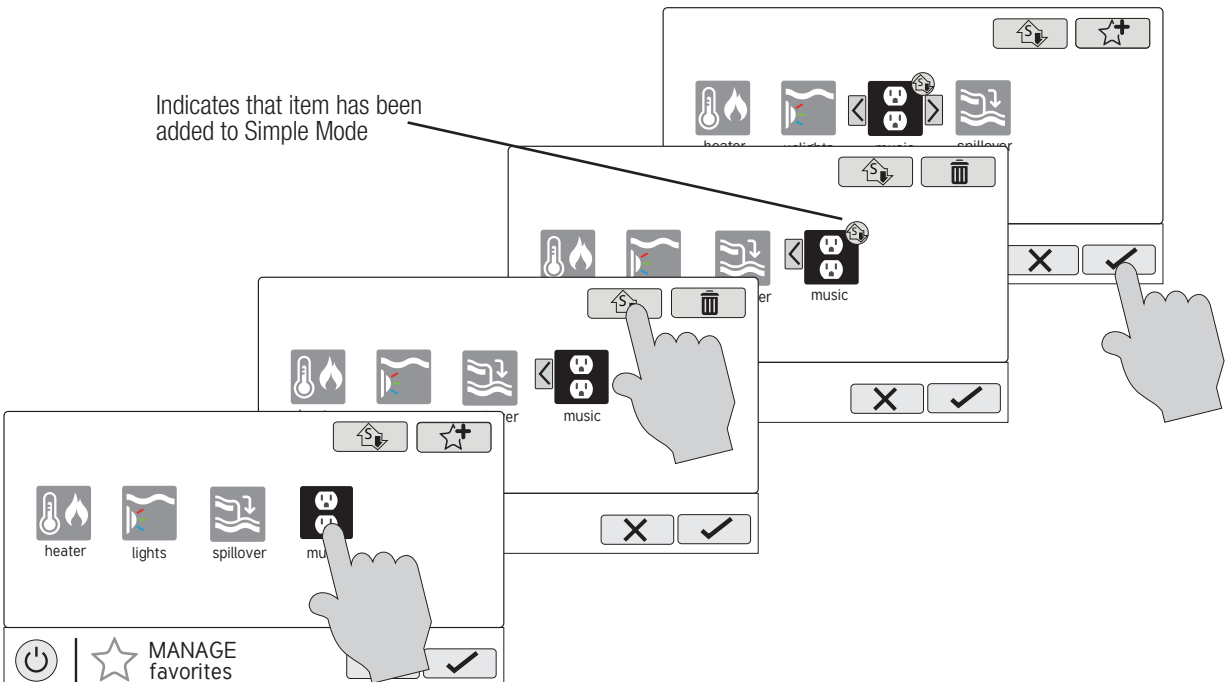

Deleting Favorites from Simple Mode

Deleting Favorites from Simple Mode is similar to adding Favorites to Simple Mode.

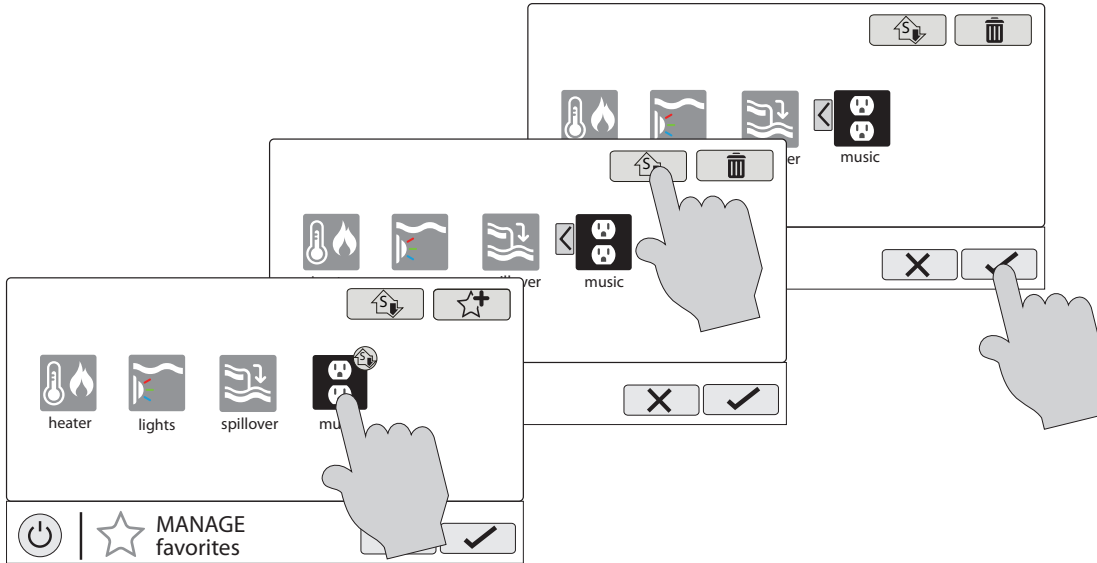

Themes

Themes allow you to execute many pool functions with just one button. This can be handy for functions that require interaction with various pool equipment. For example, spending an evening in the spa might require you to turn on the spa jets, set the spa heater to 104°, turn on music and turn on the spa lighting. Rather than manually performing these functions, they can be saved as a theme and executed with just one button. To create a Theme, put all of the pool/spa/backyard equipment into the desired state. In the example above, you would set all the equipment as described. When creating Themes, the OmniPL takes a “snapshot” of the system state/settings. This snapshot is saved as a Theme. Refer to the following diagrams and information for creating and running Themes.

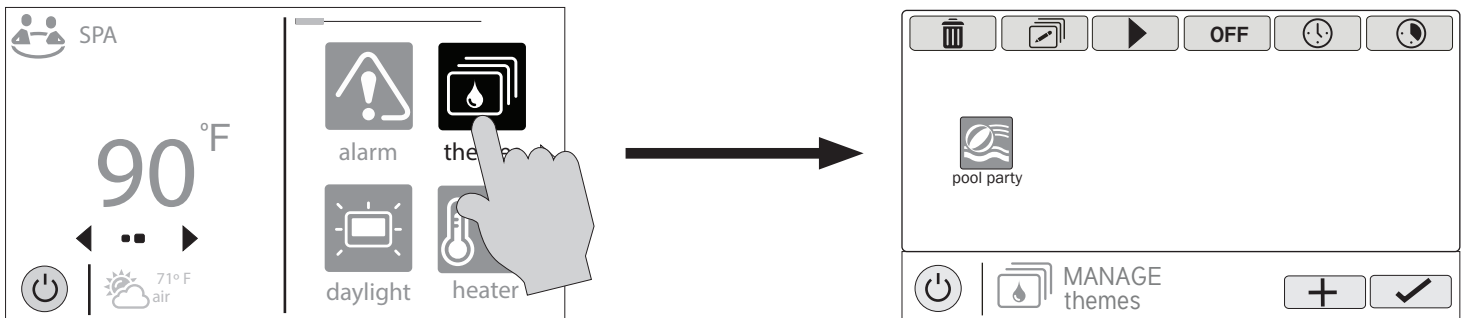

Manage Themes Screen

Edit Theme - After selecting a Theme, touch this button to edit the Theme. You can rename, change icon and set as favorite.

Start Theme - After selecting a Theme, touch this button to start the Theme.

End Theme - After selecting a Theme, touch this button to end the Theme.

Select Theme - Touch this button to select the desired Theme. You can now turn it on/off, edit, set a schedule, set a countdown timer, or delete the selection using the buttons above.



Create a Theme - Touch this button to create a Theme. Before creating, make sure all pool/spa/backyard equipment is in the desired state. NOTE: If a Spa Side remote control is configured, you'll have the option to assign the Theme to one of its buttons.

Create a Theme

To create a Theme, put all of the pool/spa/backyard equipment into the desired state.

Select an Icon - Touching this button will bring you to an icon selection screen. Touch the advance button to access more icons. Selecting and saving the icon will bring you back to this screen.

Add the Theme to Favorites - Touching this button will toggle the selection from Yes to No. Select whether you want the new Theme to be added to Favorites. If so, a new button will be generated and added to Favorites. You'll be able to turn the Theme on/off with the new Favorites button.

Name the Theme - Touching this button will bring you to a keyboard where you can enter a name for the Theme. Saving the name will bring you back to this screen.

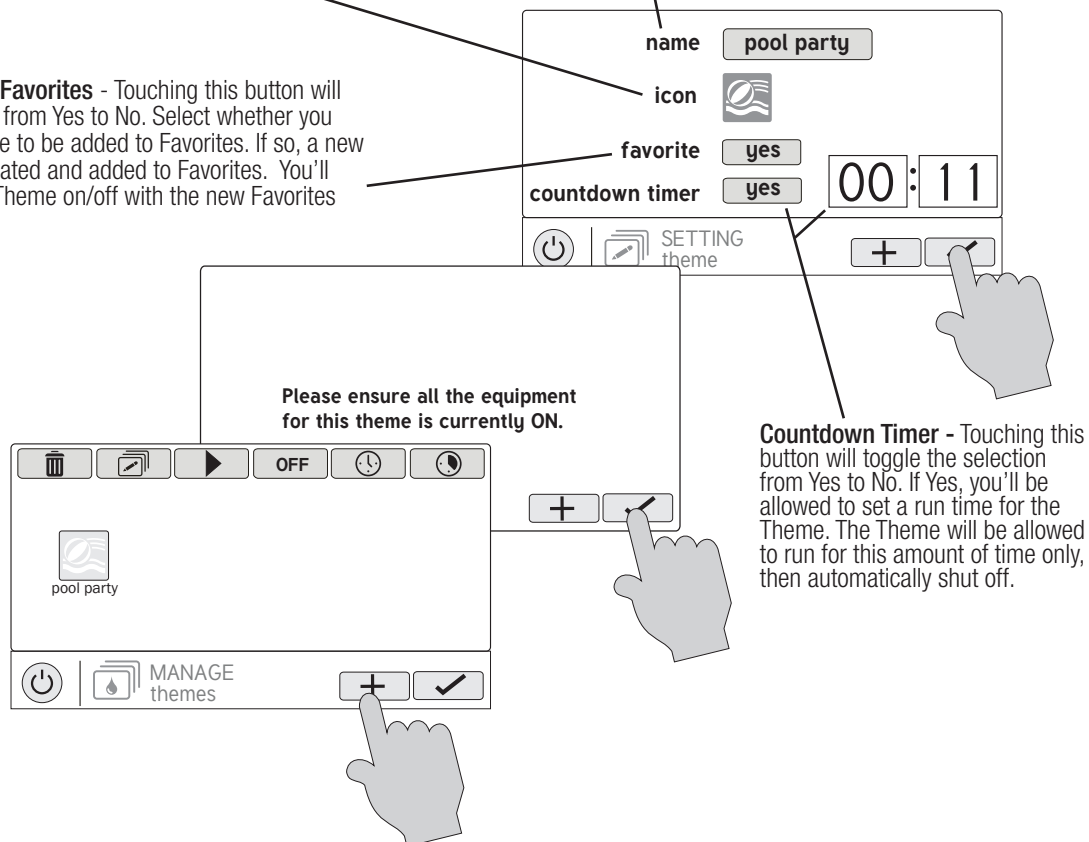

Countdown Timer - Touching this button will toggle the selection from Yes to No. If Yes, you'll be allowed to set a run time for the Theme. The Theme will be allowed to run for this amount of time only, then automatically shut off.

Starting a Theme

If a Favorite was created for the Theme, run the Theme just as you would any other Favorite. To start a Theme within the “Manage Themes” screen follow the procedure below. Note that only one Theme can run at a time.

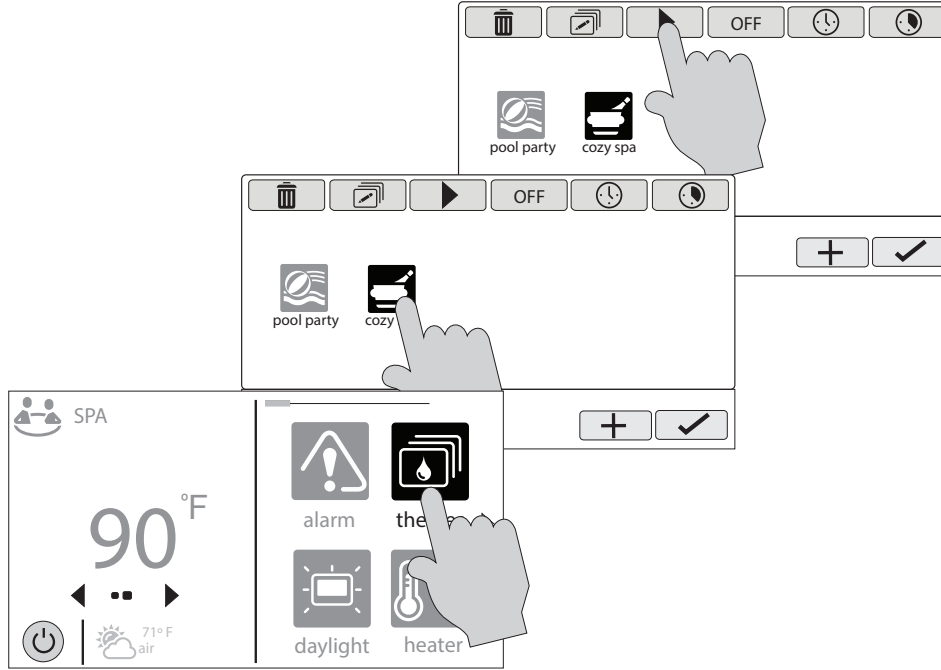

Stopping a Theme

If a Favorite was created for the Theme, stop the Theme just as you would any other Favorite. To stop a Theme within the “Manage Themes” screen follow the procedure below. Note that when stopping a theme, all functions will turn off and the filter pump will return to any schedules that have been previously set.

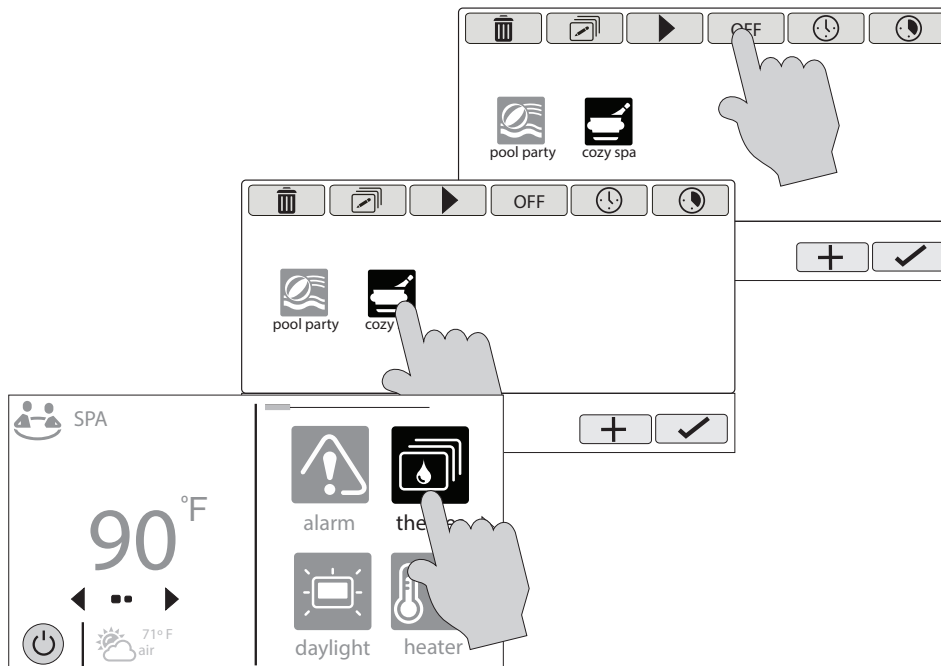



Config

The Config button offers many options related to the configuration and operation of the Omni. You can view log files, backup configuration settings, restore configuration settings, modify display settings and more.

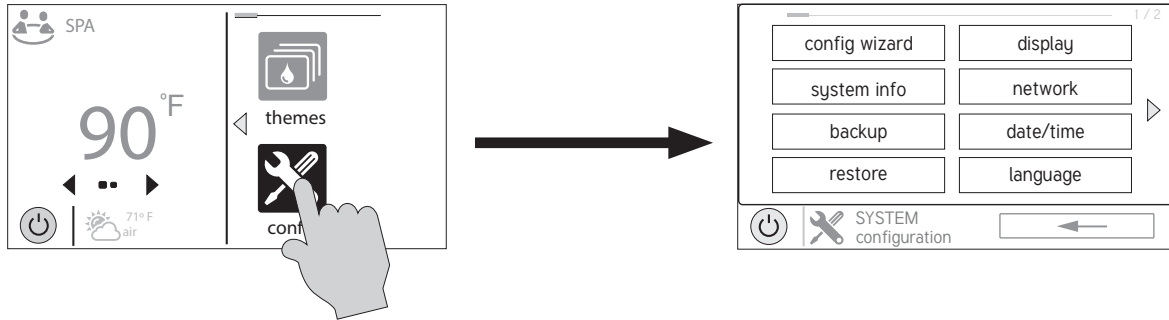

Using a USB Thumb Drive

Some options require the use of a USB thumb drive (removable media) that will be inserted in the OmniPL's Control Pad. If logging is desired (page 26), the thumb drive should be left in the OmniPL during normal operation. This connection is not waterproof so care must be taken to protect the Control Pad while logging. The location of the USB port is shown in the Installation Manual.

Config Wizard

The Configuration Wizard is used to add, remove and configure pool equipment that is controlled by the Omni. This has already been done at installation and should not be needed unless a change has been made to the system. If a new configuration is saved, it will overwrite the old configuration and may require you to change previous equipment settings.

If pool equipment is added or removed from your system you may edit the existing Configuration. Two types of editing are available; Full Edit and Quick Edit. A Full Edit will walk you through each step of the Configuration Wizard and allow you to save at the end. Refer to the Configuration Wizard Guide in the Installation Manual when using a Full Edit. A Quick Edit allows you to go directly to the equipment that you'd like to add/remove/configure. In most cases, Quick Edit will offer the most convenient way to make these changes. For more information, refer to the Quick Edit Guide section in the Installation Manual.

IMPORTANT: Existing themes are affected when new equipment is added. To ensure proper operation, delete and then re-create any existing Themes after adding new equipment regardless of whether the new equipment is used within the Theme.

System Info

System Info will show the Hayward Unique Address (HUA) and version for all smart components (components that communicate with the Omni). This may be needed by Hayward Technical Service when troubleshooting or diagnosing system issues.

Backup

You can back up your configuration settings, schedules, setpoints etc. to the OmniPL's internal memory or to a USB thumb drive. If using a thumb drive, use the instructions for inserting and removing thumb drives as explained above.



Restore

You can overwrite the existing configuration with a backup that is stored internally or on a thumb drive. You will get the following options when selecting Restore Config:

restore backup 1 - this is the last backup that was saved to internal memory.

restore backup 2 - this is the second to last backup that was saved to internal memory.

Restore from USB - you can browse the USB drive and find available backups. Backup files will begin with "MSPCONFIGxyyz" where xx=month, yy=day, and zz=year (the date the file was created). The OmniPL will automatically create a backup file when a new configuration is saved. These files end with ".xml". Backup files that are created manually end with ".bak". Both types can be restored.

To restore a backup, make your selection from above and then touch Save.

Display

The Display Settings screen offers options to customize the way the OmniPL displays information.

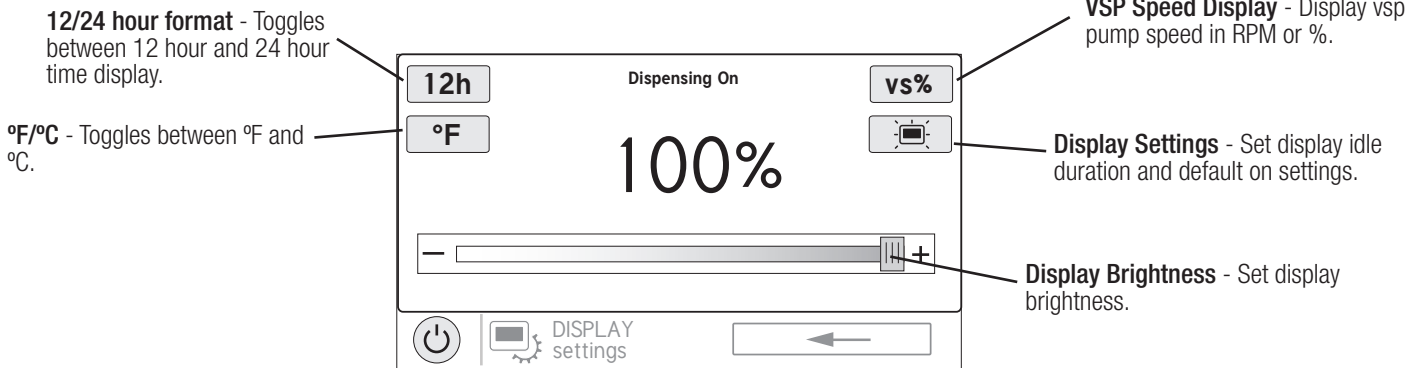
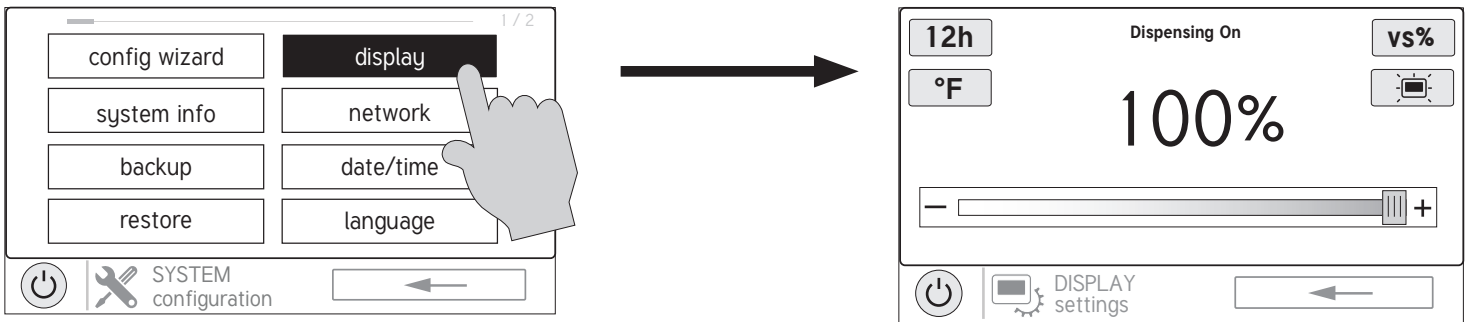

Network

You can view the OmniPL ip address at this screen. This is the address that the router will use to connect the OmniPL to the home network. You can also turn the connection to the router on and off using the On/Off toggle.

Date/Time

Although the Date/Time can be set manually, it is recommended that you select to have it updated automatically online. This method is required to receive firmware upgrades through the internet.

Language

Select a language. If a desired language is not shown, it may be available from Hayward through their website at www.hayward.com/firmware. Refer to page 30 for information on installing new languages.

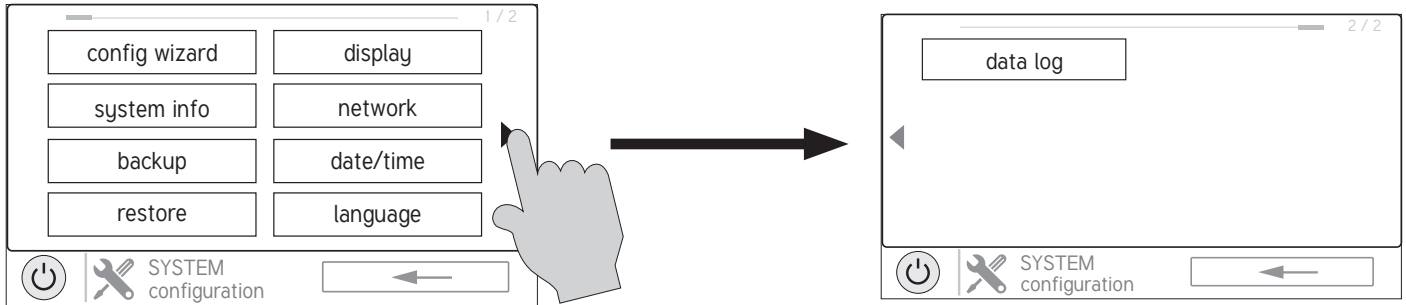

Data Log (requires Thumb Drive, page 24)

Use this feature if instructed by Hayward Technical Service. The data log shows a log of daily operation and can help Hayward Technical Service diagnose or troubleshoot problems. The Data Log options are:

Clear Log File- this will delete all data in the log file.

Show Log File - this will display the log file.

Restore Defaults - this will return the data log settings to the factory default.

Set Level - you can change the amount of detail that is shown in the log file with this button.

You can also enable and disable data logging using the On/Off toggle.

Service Mode and Firmware Upgrade

Service Mode is used for upgrading firmware, service maintenance and diagnostic functions. Note that changes within Service mode should only be made by qualified individuals who understand the connected pool equipment. Because systems will be disabled while in Service Mode, you will have an option to set a timer before entering.

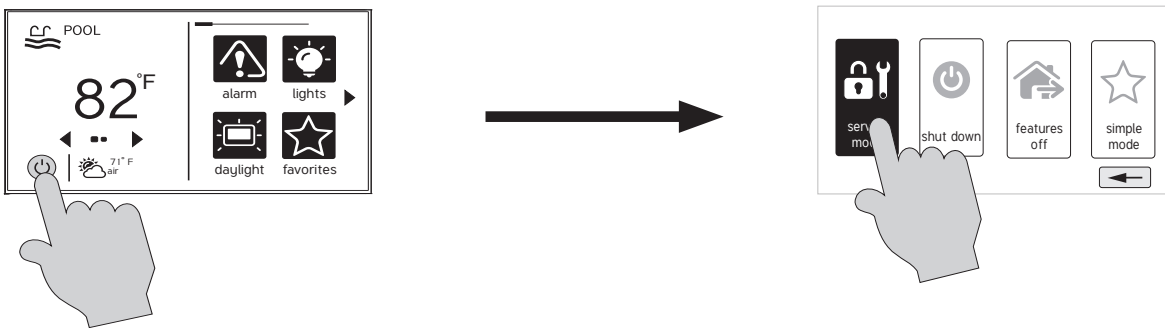



HAYWARD®

Service Mode

Because most functions in Service Mode require a qualified service professional, a brief overview is shown below. You may be asked by Hayward Technical Service to access some of these functions to provide information or help diagnose an issue.

LVR	This function allows technicians to energize/de-energize the connected low voltage relays.
HVR	This function allows technicians to energize/de-energize the connected high voltage relays.
Valve	This function allows technicians to energize/de-energize the connected valves.
Sensor	View and calibrate connected temperature sensors.
Chlorinator	View diagnostic information and test the chlorinator function.
VSP	View diagnostic information and test connected VSPs.
CS&D	View diagnostic information and test Sense and Dispense equipment.
Config	Some of the Config options operate differently while in Service Mode. There are also additional Config options available in Service Mode that are not shown in Standard Mode.

Backup - While in Service Mode, Backup adds a third option called "Clone Controller to USB". This would most likely be used by service personnel who are replacing the mainboard in the Omni. This Clone option will allow for a mirror image of the OmniPL's configuration, settings, and attached devices to be written to a USB thumb drive. After the mainboard is replaced, the OmniPL can be restored to all of the original parameters. Only one clone file can be copied to a USB drive and this option shouldn't be used to copy an image to other Omnis. For those applications, one should use the standard backup function (page 24).

Wireless Waterproof - This option displays the HUA of each connected waterproof remote control and allows you to enable or disable the units.

SC upload files - This option can be used to upload files to Hayward Technical Service for evaluation and troubleshooting.

Web Server - This is for internal use only.

Boot Image - A copy of the unit's operating system is kept on internal storage in case of file corruption. If necessary, Hayward Technical Service may instruct you to use this option.

Diag Info - This option accesses the OmniPL's diagnostic information. Hayward Technical Service might require this information to help troubleshoot or diagnose issues.

Toggle Demo Mode - Demo mode is used for display purposes only. When in Demo Mode, the OmniPL runs a simulation allowing users to view and interact with preset screens. The OmniPL is not functional when running in Demo Mode.

Datalog - Used with the guidance of Hayward Technical Service to troubleshoot or diagnose issues.

Upgrade	Use this button to upgrade firmware to the latest release. Refer to the information on the following page.
Daylight	This function will invert the colors on the display to make it easier to see in some lighting conditions.
Sysinfo	View current firmware versions for OmniPL components.
Factory Reset	Deletes all existing configuration and settings.
Calibrate	This function allows for the recalibration of the Control Pad screen.
Light Mode	Change the operation mode of Universal ColorLogic lights.

Firmware Upgrade

The OmniPL's firmware is the basic operating system that runs the unit. The OmniPL was shipped with the version of firmware that was available at the time of release. There may be a newer version available and if so, we encourage you to upgrade. Also, if you have experienced problems, Hayward Technical Support may advise you to upgrade your OmniPL firmware. To upgrade your firmware:

1. Determine your current MSP firmware version using the Sysinfo button.

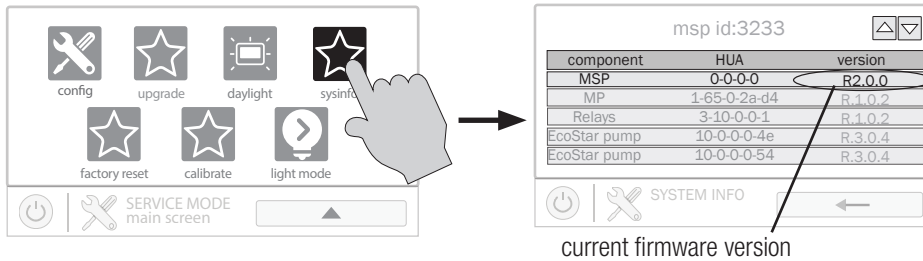

2. Using an ordinary web browser, go to www.hayward.com/firmware and compare the latest available version on the web to the current firmware version. If the firmware version on the web is greater (number is larger) than your current version, upgrade your OmniPL's firmware.

Firmware can be upgraded automatically through the internet (versions 4.0.0 or later) or manually using a thumb drive. Refer to the following information for both methods.

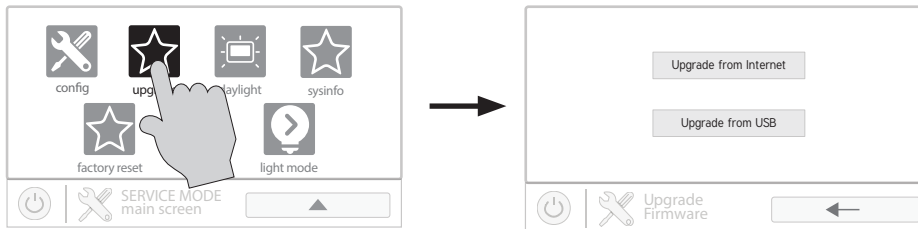

Upgrade from Internet *(Date/Time must be selected to be set automatically prior to upgrading firmware from internet- see page 25.)*

OmniPL pool controls using firmware revision 4.0.0 and later can be upgraded through the internet. Previous versions must be upgraded manually using the USB thumbdrive method described on page 29. Once updated to 4.0.0 or later, the OmniPL will alert you of available firmware updates. Note that you can select individual devices to be upgraded by touching the component name or you can upgrade all components using the "Upgrade All" button. It is recommended to upgrade all components at the same time.

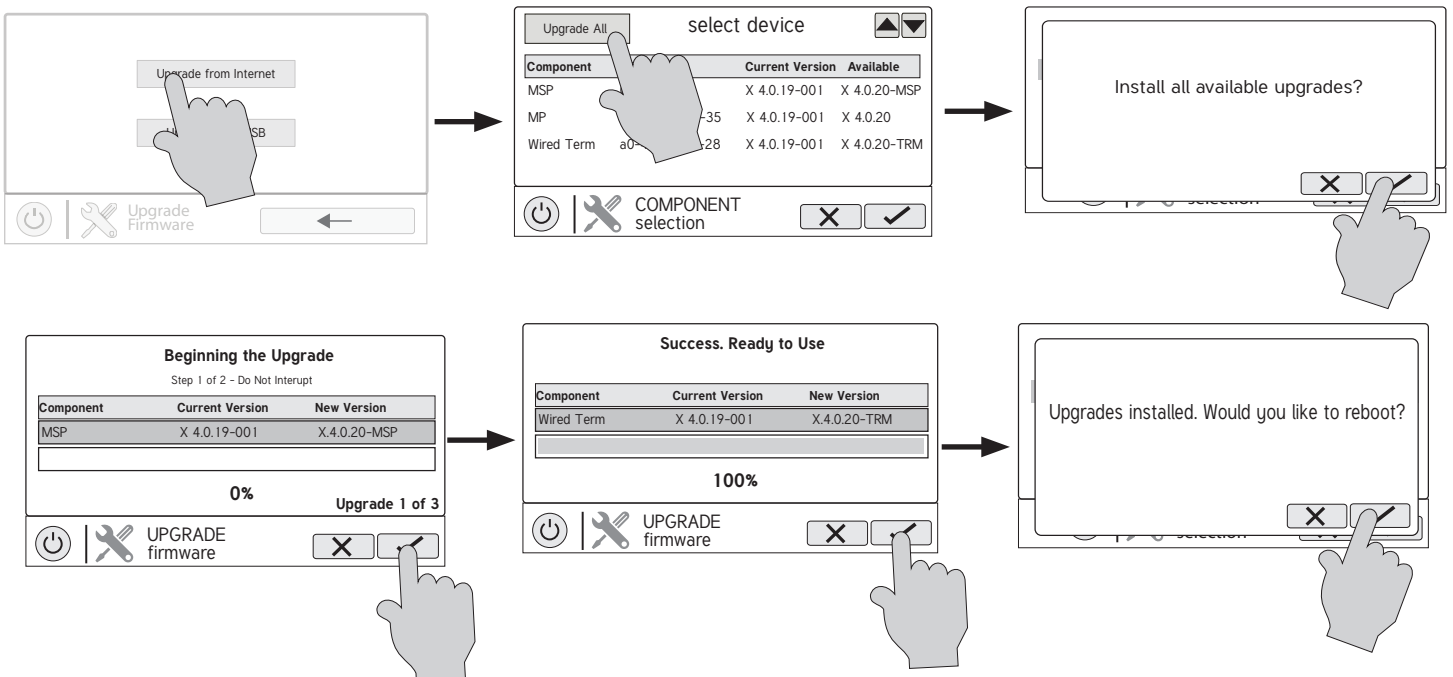

Upgrade from USB

1. Insert your USB thumb drive into your computer.
2. Go to www.hayward.com/firmware.
3. Click on the link to download the latest firmware and save to the USB thumb drive.
4. Remove the USB thumb drive from the computer.
5. Locate the port on the underside of the OmniPL Control Pad and insert the thumb drive.
6. Apply power to the OmniPL (if not already powered) and allow the OmniPL to fully start.
7. Enter Service Mode (page 26)
8. Touch the Upgrade from USB button (shown on the top of page 28)

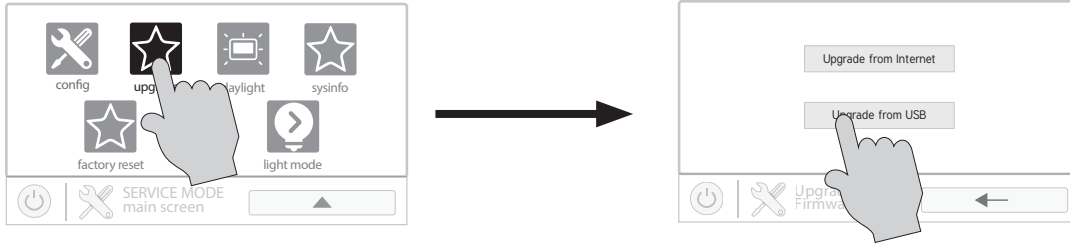

9. Select "MSP" and touch the Save button.

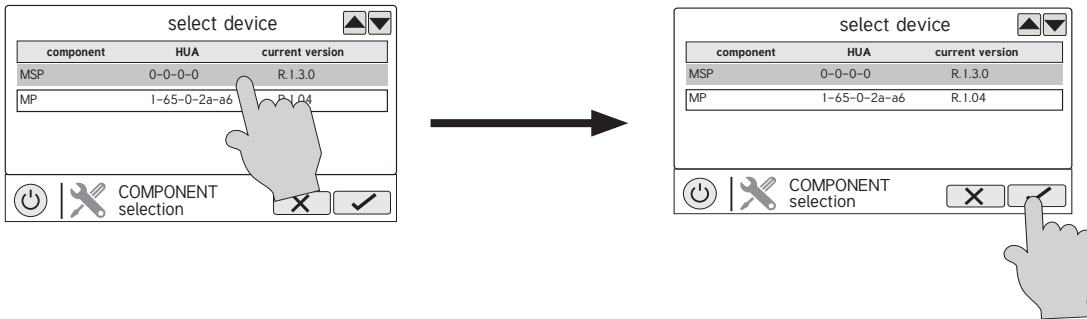

10. The OmniPL will now look at your USB thumb drive. Select the firmware file that was saved from the website and then touch the Save button.

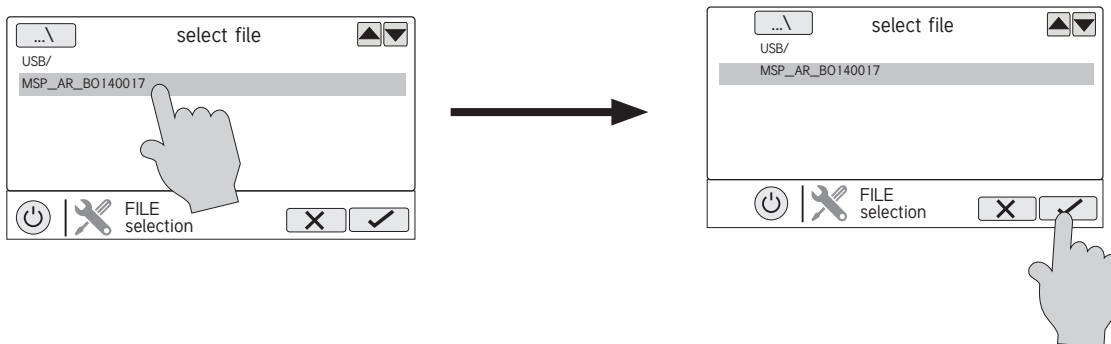



11. Touch Save to begin the upgrade. After the upgrade is finished, touch Save to restart.

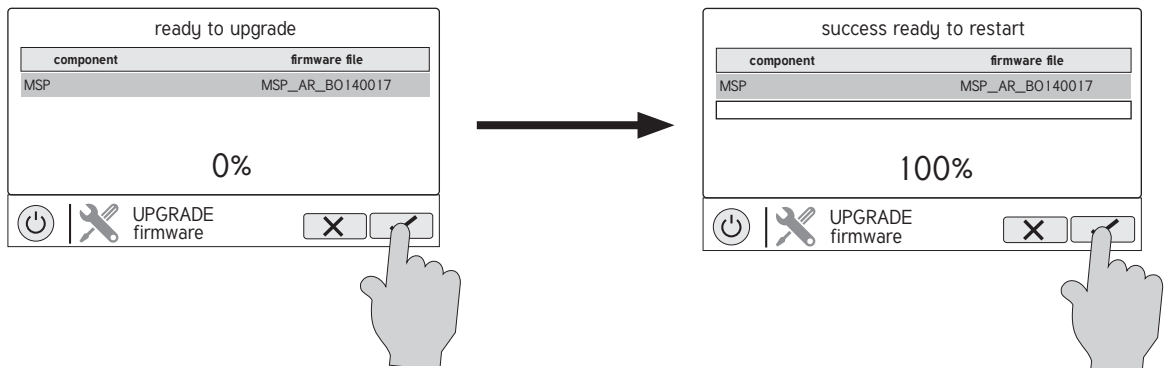

12. After the OmniPL has restarted, exit Service Mode and resume operation.

Installing a New Language

Installing a new language is the same procedure as upgrading firmware from USB. You can find OmniPL language files at www.hayward.com. To install a new language, follow the steps under "Upgrade from USB" on page 29. At step 10, select a language file instead of a firmware file. Proceed with the remaining steps.

Simple Mode

Up to this point, you've been shown how to view the Home Screen and access all of the pool's functions by using Body of Water Features (left side of Home Screen) and Favorites (right side of Home Screen). This method of access is called "Standard Mode" and offers the most information and control. An alternative to Standard Mode is "Simple Mode". Simple Mode eliminates the Home Screen and allows you to view and control only the Favorites that you specify. Simple Mode is customizable and may be preferred to Standard Mode depending on your needs. Simple Mode can provide a convenient way to access the most common functions for owners as well as a handy solution to limit access to other users. Up to 24 Favorites can be displayed in Simple Mode. Depending on the pool equipment that has been configured, some default Favorites may appear in Simple Mode. These default Favorites cannot be removed from Simple Mode. For information on how to add and delete Simple Mode Favorites, refer to the page 20 in manual.

Simple Mode Screen

Schedule Indicator - Favorites that have been configured to operate on a schedule will display this indicator.

Home Screen Information - The same information that is displayed on the Home Screen is also displayed on the Simple Mode Screen.

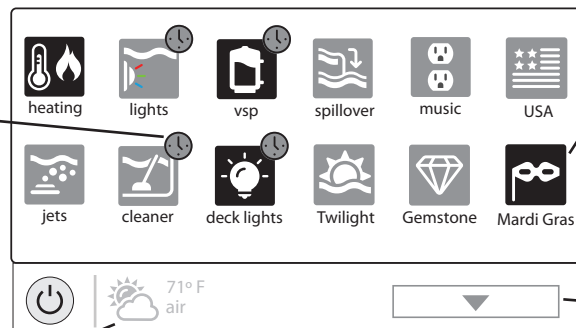

Status - Items that are highlighted are active or "On". In this example, the VSP pump, heater, deck lights and Mardi Gras light show are all On. Touching buttons in Simple Mode will turn the items On or Off.

Advance to Next Screen - If more than 12 Favorites are used in Simple Mode, this button will appear. Touch the button to advance to the next screen.

Enter Simple Mode

To enter Simple Mode, go to the Home Screen and follow the procedure below. Entering and exiting Simple Mode will require your OmniPL's MSP ID number. This number is used as a password. To find your unit's MSP ID, refer to page 32.

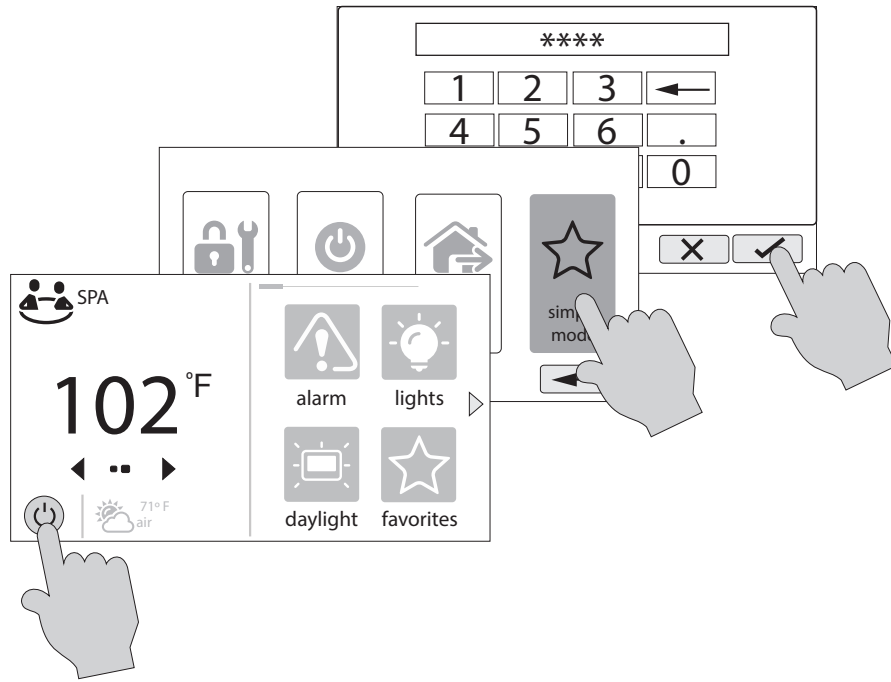

Exit Simple Mode

To exit Simple Mode, follow the procedure below.

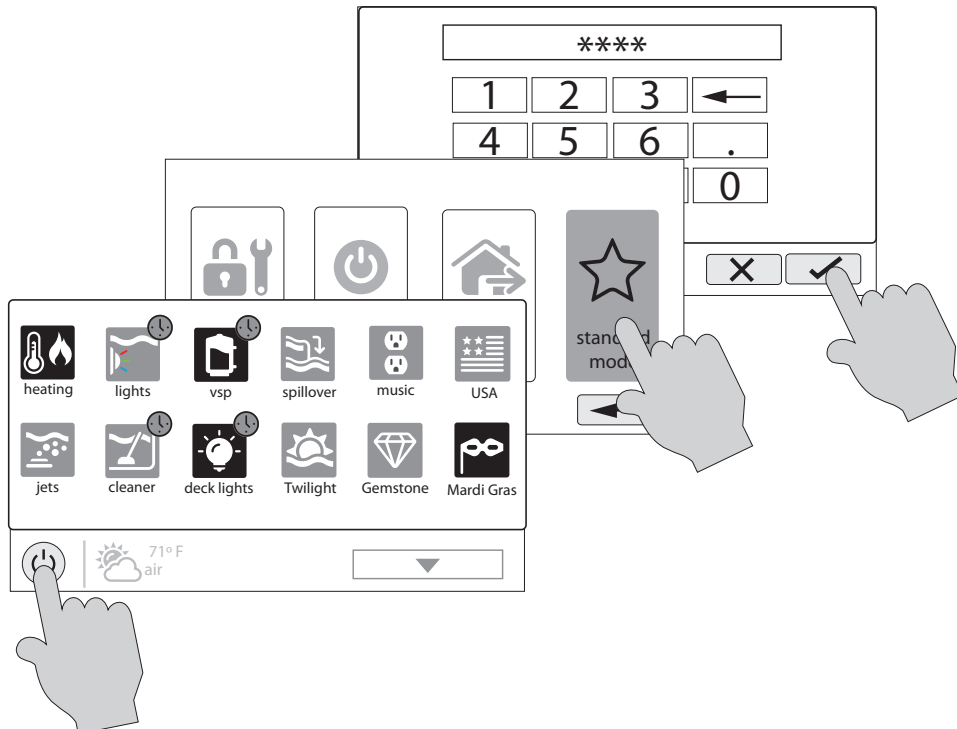



Web Enabled Control

The OmniPL should have already been configured for use with the home's router to allow for remote control through the web. This procedure is covered in the Configuration Wizard information found in the Installation Manual. After configuration, an account must be created to allow access to the OmniPL from web enabled devices. If this has not already been done by the installer, follow the procedure below.

- 1) Using an ordinary web browser, go to www.haywardomnilogic.com. If you don't already have an account, select "Register New User" and set up a new account.
- 2) Log in to your account.
- 3) Register your Omni. Registering will require you to answer a series of questions about your Omni. When asked for your Time Zone, be sure to enter the same time zone as the physical location of the installed Omni, otherwise schedules and timers will be inaccurate. You'll also be asked for an MSP System ID. This number can be found directly from the Omni. To find your unit's MSP ID, follow the procedure below:

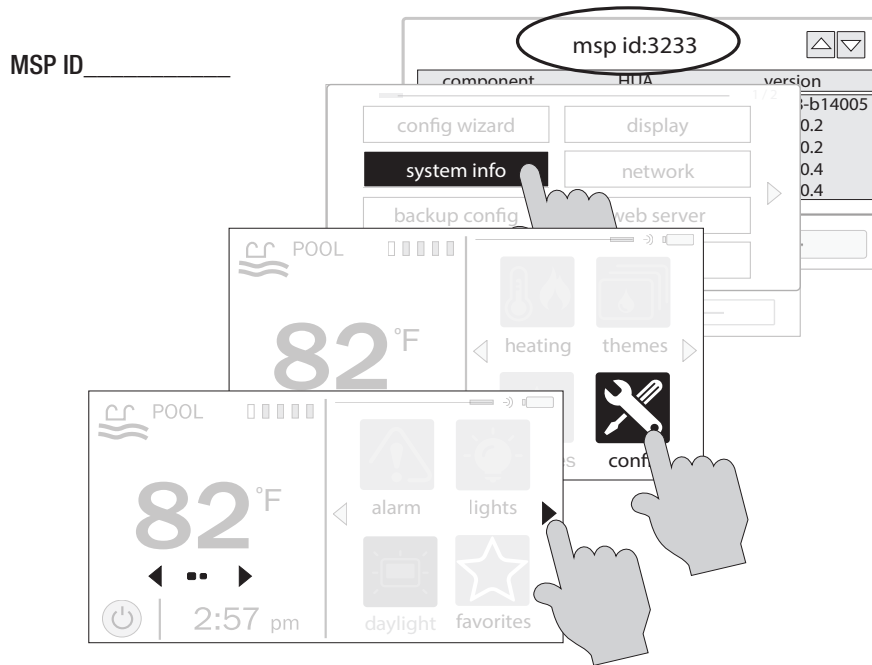

After the MSP is accepted, the OmniPL will be linked to your account. You'll be able to access the OmniPL at any time from your browser by logging into your account at haywardomnilogic.com. For mobile devices, an application must be downloaded from your device's app store. Go to www.hayward.com for more information on the availability and function of mobile apps.





HAYWARD®

LIMITED WARRANTY Hayward warrants its OmniLogic, ProLogic, OnCommand and E-Command pool automation products as well as its Aqua Rite, Aqua Rite Pro, Aqua Plus and SwimPure chlorination products to be free of defects in materials and workmanship, under normal use and service, for a period of three (3) years. Hayward also warrants its Aqua Trol chlorination products to be free of defects in materials and workmanship, under normal use and service for a period of one (1) year. These warranties are applicable from the date of purchase and only for products used exclusively on private residential swimming pools in the US and Canada. Such products for use on commercial pools in the US and Canada are covered for a period of one (1) year from date of purchase for defects in materials and workmanship. Hayward warrants all accessories and replacement parts for the above-identified pool automation and chlorination products for a period of one (1) year. Accessories include remotes, actuators, base stations, temperature sensors, flow switches and chemistry probes. Each of these warranties is not transferable and applies only to the original owner.

Hayward shall not be responsible for cartage, removal, repair or installation labor or any other such costs incurred in obtaining warranty replacements or repair.

Proof of purchase is required for warranty service. If written proof of purchase is not provided, the manufacturing date code will be the sole determinant of the date of purchase of the product. To obtain warranty service or repair, please contact the place of purchase or the nearest Hayward authorized warranty service center. For more information on authorized service centers please contact the Hayward Technical Service Support Center (61 Whitecap Road, North Kingstown RI, 02852) or visit the Hayward website at www.hayward.com.

WARRANTY EXCLUSIONS:

1. Use of non-Hayward material or unauthorized workmanship during installation.
2. Damage resulting from improper installation including installation on pools larger than the product rating.
3. Problems resulting from failure to install, operate or maintain the product(s) in accordance with the recommendations contained in the owner's manual(s).
4. Problems resulting from failure to maintain pool water chemistry in accordance with the recommendations in the owner's manual(s).
5. Problems resulting from tampering, accident, abuse, negligence, unauthorized repairs or alternations, fire, flood, lightning, freezing, external water, degradation of natural stone used in or immediately adjacent to a pool or spa, war or acts of God.
6. Use of a non- Hayward replacement salt chlorination cell on any Hayward automation or chlorination product.

The express limited warranty above constitutes the entire warranty of Hayward Pool Products with respect to its products and is in lieu of all other warranties, express or implied, including warranties of merchantability or fitness for a particular purpose. In no event shall Hayward Pool products be responsible for any consequential, special or incidental damages of any nature. Some states do not allow a limitation on how long an implied warranty lasts, or the exclusion of incidental or consequential damages, so the above limitation may not apply to you. This warranty gives you specific legal rights, and you may also have other rights, which vary from state to state.



⚠ WARNING - Read and follow all instructions in this owner's manual and on the equipment. Failure to follow instructions can cause severe injury and/or death.

⚠ WARNING – Suction Entrapment Hazard.



Suction in suction outlets and/or suction outlet covers which are, damaged, broken, cracked, missing, or unsecured can cause severe injury and/or death due to the following entrapment hazards:



Hair Entrapment- Hair can become entangled in suction outlet cover.



Limb Entrapment- A limb inserted into an opening of a suction outlet sump or suction outlet cover that is damaged, broken, cracked, missing, or not securely attached can result in a mechanical bind or swelling of the limb.



Body Suction Entrapment- A negative pressure applied to a large portion of the body or limbs can result in an entrapment.

Evisceration/ Disembowelment - A negative pressure applied directly to the intestines through an unprotected suction outlet sump or suction outlet cover which is, damaged, broken, cracked, missing, or unsecured can result in evisceration/ disembowelment.



Mechanical Entrapment- There is potential for jewelry, swimsuit, hair decorations, finger, toe or knuckle to be caught in an opening of a suction outlet cover resulting in mechanical entrapment.

⚠ WARNING - To Reduce the risk of Entrapment Hazards:

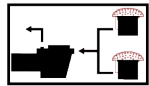

- o When outlets are small enough to be blocked by a person, a minimum of two functioning suction outlets per pump must be installed. Suction outlets in the same plane (i.e. floor or wall), must be installed a minimum of three feet (3') [1 meter] apart, as measured from near point to near point.
- o Dual suction fittings shall be placed in such locations and distances to avoid “dual blockage” by a user.
- o Dual suction fittings shall not be located on seating areas or on the backrest for such seating areas.
- o The maximum system flow rate shall not exceed the flow rating of as listed on Table 1.
- o Never use Pool or Spa if any suction outlet component is damaged, broken, cracked, missing, or not securely attached.
- o Replace damaged, broken, cracked, missing, or not securely attached suction outlet components immediately.
- o In addition two or more suction outlets per pump installed in accordance with latest ASME, APSP Standards and CPSC guidelines, follow all National, State, and Local codes applicable.
- o Installation of a vacuum release or vent system, which relieves entrapping suction, is recommended.

⚠ WARNING – Failure to remove pressure test plugs and/or plugs used in winterization of the pool/spa from the suction outlets can result in an increase potential for suction entrapment as described above.

⚠ WARNING – Failure to keep suction outlet components clear of debris, such as leaves, dirt, hair, paper and other material can result in an increase potential for suction entrapment as described above.

⚠ WARNING – Suction outlet components have a finite life, the cover/grate should be inspected frequently and replaced at least every ten years or if found to be damaged, broken, cracked, missing, or not securely attached.

⚠ CAUTION – Components such as the filtration system, pumps and heater must be positioned so as to prevent their being used as means of access to the pool by young children. To reduce risk of injury, do not permit children to use or climb on this product. Closely supervise children at all times. Components such as the filtration system, pumps, and heaters must be positioned to prevent children from using them as a means of access to the pool.



⚠ WARNING – Hazardous Pressure. Pool and spa water circulation systems operate under hazardous pressure during start up, normal operation, and after pump shut off. Stand clear of circulation system equipment during pump start up. Failure to follow safety and operation instructions could result in violent separation of the pump housing and cover, and/or filter housing and clamp due to pressure in the system, which could cause property damage, severe personal injury, or death. Before servicing pool and spa water circulation system, all system and pump controls must be in off position and filter manual air relief valve must be in open position. Before starting system pump, all system valves must be set in a position to allow system water to return back to the pool. Do not change filter control valve position while system pump is running. Before starting system pump, fully open filter manual air relief valve. Do not close filter manual air relief valve until a steady stream of water (not air or air and water) is discharged.



⚠ WARNING – Separation Hazard. Failure to follow safety and operation instructions could result in violent separation of pump and/or filter components. Strainer cover must be properly secured to pump housing with strainer cover lock ring. Before servicing pool and spa circulation system, filters manual air relief valve must be in open position. Do not operate pool and spa circulation system if a system component is not assembled properly, damaged, or missing. Do not operate pool and spa circulation system unless filter manual air relief valve body is in locked position in filter upper body. **Never operate or test the circulation system at more than 50 PSI.**



⚠ WARNING – Risk of Electric Shock. All electrical wiring **MUST** be in conformance with applicable local codes, regulations, and the National Electric Code (NEC). Hazardous voltage can shock, burn, and cause death or serious property damage. To reduce the risk of electric shock, do **NOT** use an extension cord to connect unit to electric supply. Provide a properly located electrical receptacle. Before working on any electrical equipment, turn off power supply to the equipment. To reduce the risk of electric shock replace damaged wiring immediately. Locate conduit to prevent abuse from lawn mowers, hedge trimmers and other equipment. Do **NOT** ground to a gas supply line.

⚠ WARNING – Risk of Electric Shock Failure to ground all electrical equipment can cause serious or fatal electrical shock hazard. Electrical ground all electrical equipment before connecting to electrical power supply.

⚠ WARNING – Risk of Electric Shock Failure to bond all electrical equipment to pool structure will increase risk for electrocution and could result in injury or death. To reduce the risk of electric shock, see installation instructions and consult a professional electrician on how to bond all electrical equipment. Also, contact a licensed electrician for information on local electrical codes for bonding requirements.

Notes to electrician: Use a solid copper conductor, size 8 or larger. Run a continuous wire from external bonding lug to reinforcing rod or mesh. Connect a No. 8 AWG (8.4 mm²) [No. 6 AWG (13.3 mm²) for Canada] solid copper bonding wire to the pressure wire connector provided on the electrical equipment and to all metal parts of swimming pool, spa, or hot tub, and metal piping (except gas piping), and conduit within 5 ft. (1.5 m) of inside walls of swimming pool, spa, or hot tub.

IMPORTANT - Reference NEC codes for all wiring standards including, but not limited to, grounding, bonding and other general wiring procedures.

⚠ WARNING – Risk of Electric Shock . The electrical equipment must be connected only to a supply circuit that is protected by a ground-fault circuit-interrupter (GFCI). Such a GFCI should be provided by the installer and should be tested on a routine basis. To test the GFCI, push the test button. The GFCI should interrupt power. Push reset button. Power should be restored. If the GFCI fails to operate in this manner, the GFCI is defective. If the GFCI interrupts power to the electrical equipment without the test button being pushed, a ground current is flowing, indicating the possibility of an electrical shock. Do not use this electrical equipment. Disconnect the electrical equipment and have the problem corrected by a qualified service representative before using.

⚠ CAUTION – HAYWARD® pumps are intended for use with permanently-installed pools and may be used with hot tubs and spas if so marked. Do not use with storable pools. A permanently-installed pool is constructed in or on the ground or in a building such that it cannot be readily disassembled for storage. A storable pool is constructed so that it is capable of being readily disassembled for storage and reassembled to its original integrity.

SAVE THESE INSTRUCTIONS

90 DAY EXTENDED WARRANTY* REGISTER WITH YOUR SMARTPHONE

— PROTECT YOUR INVESTMENT IN 2 EASY STEPS —

1. TAKE A PHOTO

Take a photo of the camera icon

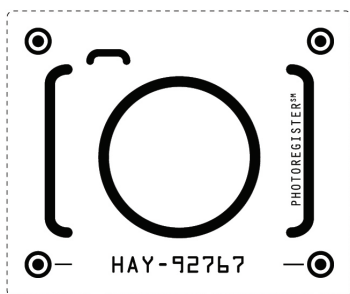

2. SEND IT IN

Send it in using one of the methods below



SMARTPHONE

Text a photo of the camera icon to **71403**

OR



ONLINE

Visit Hayward.com/Warranty

OR



MESSENGER

Send photo to **photoregister**

*Extended warranty is in addition to applicable product warranty and is for parts only, labor not included.
Need help? Visit photoregister.com/help or text HELP to 71403.

FOR FURTHER INFORMATION OR CONSUMER
TECHNICAL SUPPORT, VISIT OUR WEBSITE AT
www.hayward.com



HAYWARD®



Hayward is a registered trademark and OmniPL is a trademark of Hayward Industries, Inc. © 2021 Hayward Industries, Inc.

All other trademarks not owned by Hayward are the property of their respective owners. Hayward is not in any way affiliated with or endorsed by those third parties.

USE ONLY HAYWARD GENUINE REPLACEMENT PARTS