



Installation and Operation Manual

Model: Power Defender 140 for Waterway

Programmable Pool Pump Motor/Control



This product does **NOT** provide a Safety Vacuum Release System (SVRS).

Save this instruction manual for future reference.

Table of Contents

Important Safety Information	1
Power Defender 140 for Waterway	3
Features	3
Dimensions (Square Flange)	4
Dimensions (Thru Bolt with Base)	5
Electrical Requirements	6
Input	6
Rated Output	6
Agency	7
Safety	7
Electromagnetic Compatibility (EMC)	7
Installation Instructions	8
Protect against Heat	8
Protect against Dirt	8
Protect against Moisture	8
Preparing the Motor for Operation	8
Wiring the Motor	9
Motor Protections	11
Low Temperature Monitor	11
Motor Stalled	11
Open Output Phase	11
Output Over Current	11
Output Over Power	11
Power Module Temperature	11
Under Voltage	11
Hardware Protection	12
Mechanical Requirements	12
Environmental Requirements	12
Pump Control via the User Interface	13
Navigation Overview	13
Configure Your Pool Pump Motor	19
Overriding a Timer	23
Wiring a Remote Connection	24
Troubleshooting	25
Basic Troubleshooting	25
General Troubleshooting	26
Fault Conditions	27
Maintenance	30
Lowering Your Utility Costs	30
Example Calculations	30
Default Settings	31
Warranty Information	33

Important Safety Information

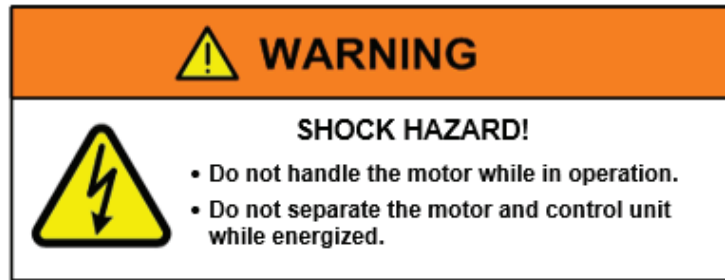

WARNING

- Read all instructions thoroughly and be familiar with the equipment before installing or working on it.
- Before connecting or disconnecting cables or other electrical connections, verify that electrical power to the system is removed. Failure to comply may cause serious damage to the pool pump motor or injury.
- Because of the risk of electric shock, only individuals thoroughly trained in the use of multimeters should conduct voltage tests.
- Never touch the metal contacts on the multimeter during a test.
- Always check testing equipment for proper operation before use.

WARNING

Installation, operation, and maintenance must be performed by qualified personnel. Familiarization with and adherence to the National Electrical Code (NEC), National Fire Protection Association (NFPA) standards and to local codes are required. It is important to observe safety precautions to protect personnel from possible injury. Personnel should be instructed for handling each of the following:

- Only apply nameplate voltage (115 or 230) with the Voltage Selection Switch in the correct position.
- Insulate all connections carefully to prevent grounding or short circuits. Reinstall all conduit and terminal box covers.
- To avoid overheating or loss of output power, voltage to the motor control unit must be within plus or minus 10% of the nameplate voltage.
- Make sure the unit is electrically grounded and that proper electrical installation, wiring, and controls are used consistent with local and national electric codes. Refer to **NEC Handbook and NFPA No. 70**. Employ qualified electricians for the installation and maintenance of the unit.
- Code requirements differ from state to state. Install equipment using qualified electricians in accordance with the applicable codes and ordinances in your area and in accordance with NEC. All electrical connections should be made and maintained by a qualified or licensed electrician.
- Make sure there are no unusual noises or vibrations when the motor is running.
- Avoid contact with energized circuits and rotating parts.
- Provide proper safeguards for personnel against rotating parts.

Power Defender 140 for Waterway Pool Pump Motor

WARNING

- Always disconnect electrical power at the fuse box or circuit breaker panel before handling electrical connections or performing maintenance on this unit. Allow the motor to come to a complete stop and wait two (2) minutes. This allows the capacitors to discharge any residual voltage.
- All aspects of the installation must conform to the applicable requirements of the NEC, including **Article 430 (Motor Circuits and Controllers)**, as well as all local codes.
- Double-check to make sure that electrical power is removed and that it cannot be turned on while you are working on the equipment.
- A poor electrical connection can overheat and cause terminal and/or terminal board failures. Examine the connections carefully for any signs of physical deterioration or loose fit to the motor terminal block.
- Care must be taken to assure connections are made to the proper terminals and adequate electrical clearances are maintained.
- The control unit on the motor contains hazardous voltage.

CAUTION

- Wear safety glasses to inspect the equipment while it is running or while working on equipment.

NOTICE

The motor and control unit are assembled and calibrated as a set. There are no serviceable parts in the motor or control.

- **Do not** lift the Power Defender 140 for Waterway motor by the electronic control.
- To prevent permanent damage to the unit, only apply nameplate voltage.
- **Do not** strike the motor shaft with a hammer or other tool as this may cause damage.
- Voltage symbols vary among different multimeters and may be displayed as Vac, AC, V, or a V beneath a wavy line. Select the correct symbol and set the multimeter to the voltage closest to but higher than the voltage you are measuring.
- Although designed for outdoor application, the Power Defender 140 for Waterway Pool Pump Motor is properly packaged for shipment and storage and should be kept in a clean and dry indoor area until installed for use.

Power Defender 140 for Waterway

The Power Defender 140 for Waterway variable speed pool pump motor is a premium efficient product that includes a fully integrated motor, control, and User Interface (UI). The product provides programming flexibility and speed range capability. It is also designed to communicate and operate with a variety of external system controls, in addition to the on-board User Interface.

Features

- Total Output Horsepower: 1.40HP, 40° C (1.25HP, 50° C) at 3450 RPM, variable speed
- Voltage/Hertz: Single phase, 115 and 230 Vac, 50 or 60 Hz
- Speed Range: 600-3450 RPM
- Efficiency: 80% at 3450 RPM
- Enclosure: Finned Aluminum enclosure providing a Water Ingress Protection level of IPX5 for long field life in outdoor environmental conditions
- Frame: Square Flange (NEMA 42Y mounting), Thru Bolt with Base
- User Interface: Fully functional, easy to operate
- Rotation: Counter-clockwise (viewing motor shaft)
- Low Temperature Monitor: Threshold temperature configurable in the UI
- Capable of communicating with specific pool control systems via MODBUS
- Capable of setting up to seven daily schedules
- Adjustable priming time & speed
- Menu keypad lockout
- Designed for quiet operation
- Fully Integrated: Designed for simple “Drop-In” installation with no complex wiring
- UL 1081 approvable



Square Flange



Thru Bolt with Base

Power Defender 140 for Waterway Pool Pump Motor

Dimensions (Square Flange)

All dimensions are for reference only.

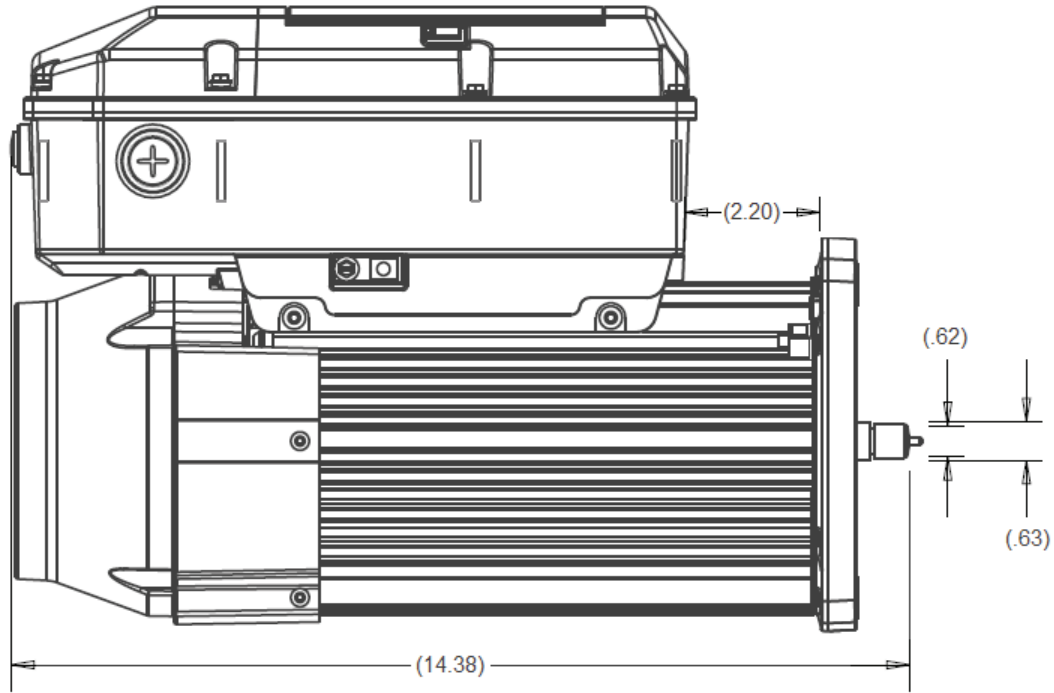

Side View

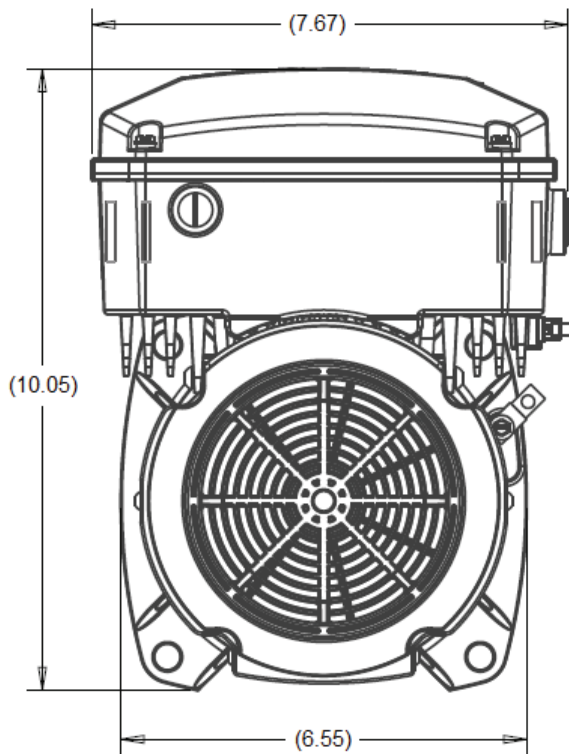

Fan View

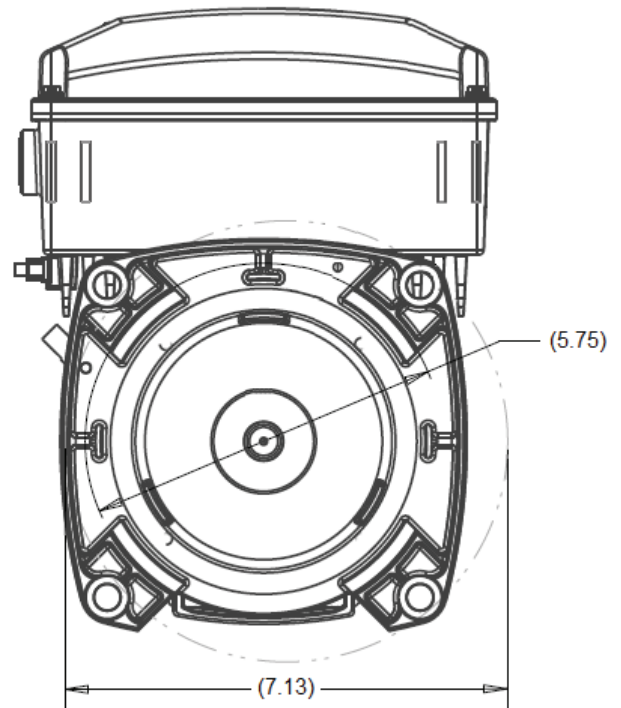

Shaft View

Power Defender 140 for Waterway Pool Pump Motor

Dimensions (Thru Bolt with Base)

All dimensions are for reference only.

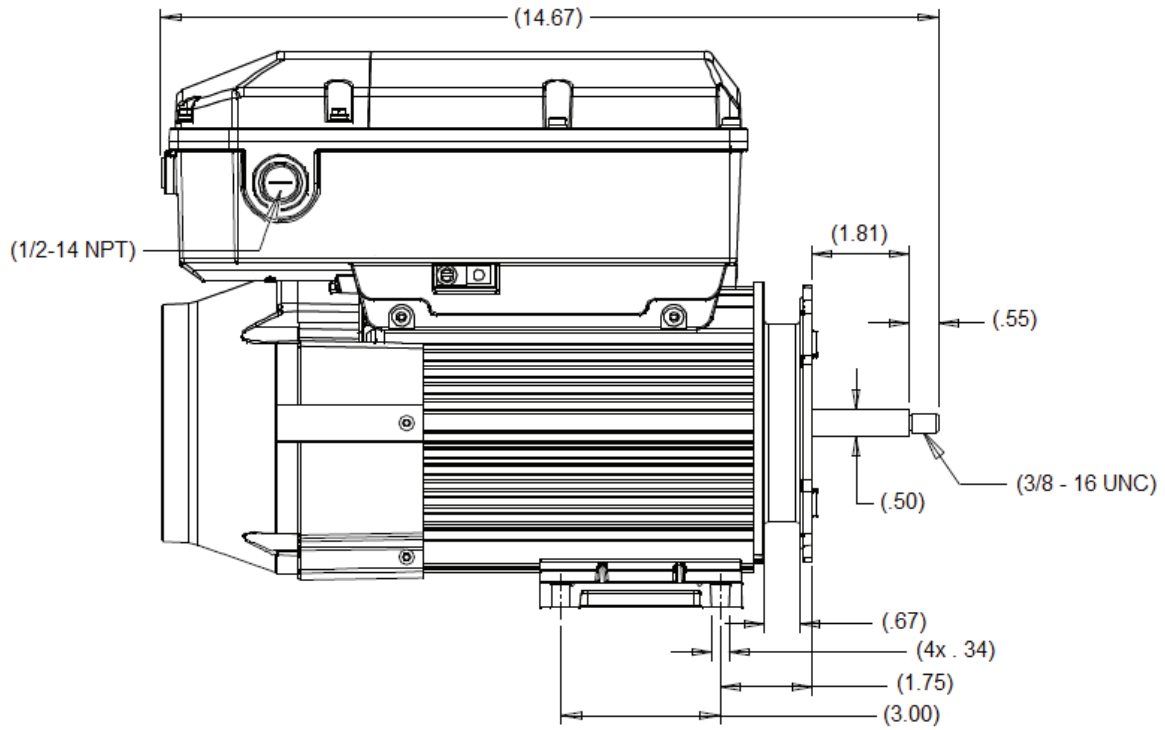

Side View

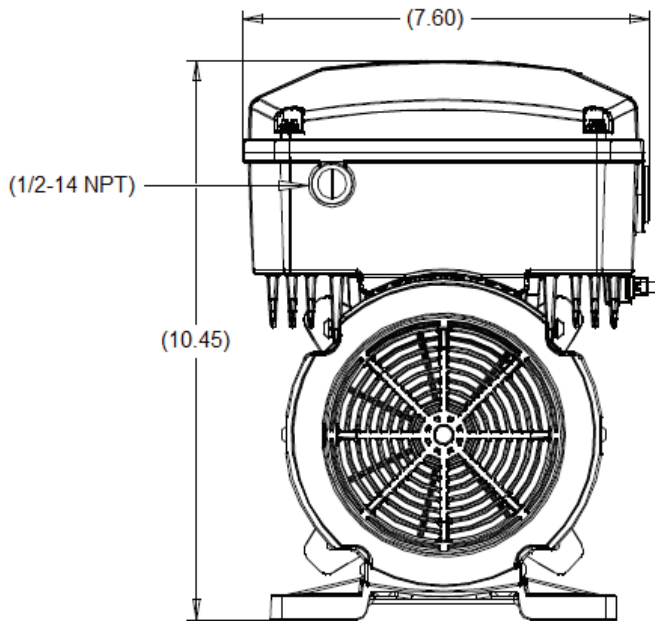

Fan View

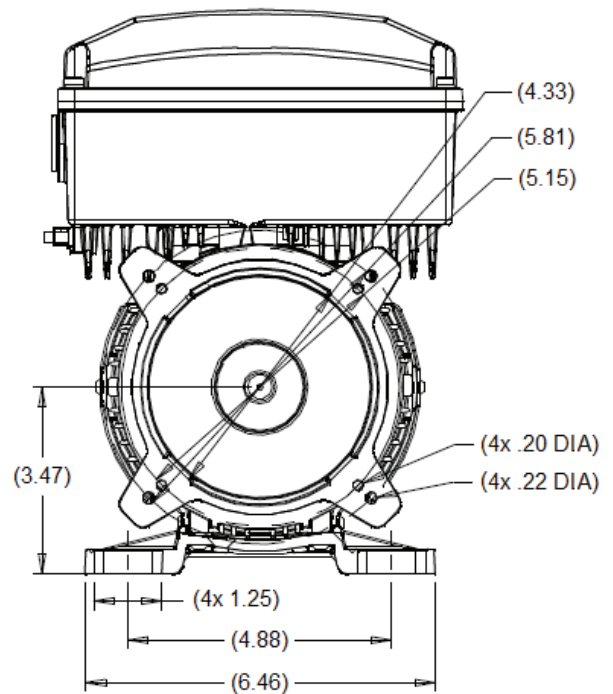

Shaft View

Electrical Requirements

Input

Input Line Voltage

The unit is intended to be operated from a 115 or 230 Vac single phase power supply. The input AC supply frequency is 50 or 60 Hz nominal. Full rated output power is guaranteed between the Minimum Full Performance Voltage and the Maximum Operating Voltage. The unit operates with frequency variations up to +/-10 percent of the nominal value.

Line Input 1Ø	Minimum Operating Voltage	Minimum Full Performance Voltage	Maximum Operating Voltage
115 Vac	104 Vac	104 Vac	127 Vac
230 Vac	207 Vac	207 Vac	264 Vac

Input Line Current

Full load AC line currents are listed below. The inverter limits the inrush current to less than 150A peak surge. The duration is less than 5 milliseconds.

AC Input	Full Load Current
115 Vac	15.6 amps
230 Vac	9.5 amps

Input Power Factor

There is no power factor correction circuit on the motor control board. Power factor range is normally 65 to 75%.

Rated Output

The unit is rated for the following maximum outputs:

HP	Speed (RPM)	Rated Torque
1.40HP	3450	25.5 in-lb.

Agency

UL File Number:

- E503587 (control)
- E255002 (motor and control)

Safety

Document	Description
UL 60730-1	Principal standard for the design of an electronically protected motor.
UL 1998	Safety standard for software in programmable components of an electronically protected motor.
UL1081 (approvable)	Standard for Safety: Swimming Pool Pumps, Filters and Chlorinators.
UL 1004-1	Standard for Rotating Electrical Machines - General Requirements.
UL 1004-7	Standard for Electronically Protected Motors.

Electromagnetic Compatibility (EMC)

Document	Description
CISPR 22/EN55022	Standards applicable to information technology equipment.
IEC/EN 61000-4-2	Testing and measurement techniques - Electrostatic Discharge Immunity Test.
IEC/EN 61000-4-4	Testing and measurement techniques - Electrical Fast Transient/Burst Immunity Test.
IEC/EN 61000-4-5	Testing and measurement techniques - Surge Immunity Test.

Installation Instructions

Follow these instructions to prolong the life of the pump motor and control. Install the product on a secure and level platform or base, such as a concrete pad.



Installation, operation, and maintenance must be performed by qualified personnel. Familiarization with and adherence to the National Electrical Code (NEC), National Fire Protection Association (NFPA) standards and to local codes are required. It is important to observe safety precautions to protect personnel from possible injury.

- Code requirements differ from state to state. Install equipment using qualified electricians in accordance with the applicable codes and ordinances in your area and in accordance with NEC. All electrical connections should be made and maintained by a qualified or licensed electrician.

Protect against Heat

- Shade the motor / control from the sun.
- Provide ample cross ventilation.
- Protect the motor / control from lint, etc., which can clog the ventilation openings.

Protect against Dirt

- Keep the motor / control and the surrounding area clean.
- Avoid sweeping or stirring dust near the motor / control while it is running.
- Avoid storing or spilling dry chemicals near the motor / control.

Protect against Moisture

- Provide protection from rain, snow, etc.
- **Do not** wrap the motor / control with plastic or other air tight materials.
- Locate the motor / control on a slight elevation so that water does not run or puddle nearby.
- Avoid splashing water on or near the motor / control.
- Repair leaky pipe joints or pump seals promptly.

Preparing the Motor for Operation

The Power Defender 140 for Waterway has been functionally tested before shipment. Most pool installations already have the electrical power in conduit. However, on-site installation requirements and electrical codes vary widely and are the responsibility of the installer. The motor / control must be wired before operating.

Note: An electrical power cable is **not** provided.

You will need the following tools.

- 1/4-inch socket or nut driver
- Flathead or Phillips screwdriver

Wiring the Motor

Follow the steps outlined below to wire the Power Defender 140 for Waterway Pool Pump Motor.

WARNING

- Always disconnect electrical power at the fuse box or circuit breaker panel before handling electrical connections or performing maintenance on the motor. Allow the motor to come to a complete stop and wait two (2) minutes. This allows the control bus capacitors to discharge any residual voltage.
 - The control unit on the motor contains hazardous voltage.
1. Remove the four (4) slotted head hex washer screws securing the Wiring Compartment Cover. Set the cover aside.
 2. Remove the three (3) slotted head hex washer screws securing the High Voltage Compartment Cover over the AC Input Terminal Block and set the cover aside (Figure 1).



Figure 1 – High Voltage Compartment

3. The motor ships from the factory connected for **230 Vac** power. (230 is visible on the **Voltage Selection Switch**). You can also run the motor on **115 Vac**.

WARNING

- Confirm the incoming voltage before making the voltage selection, wiring, and operating the motor. Incorrect voltage can damage the motor and control.
- If **230 Vac** is correct, no action is needed. Proceed to **Step 5**.
- If **115 Vac** is required, proceed to **Step 4**.

Power Defender 140 for Waterway Pool Pump Motor

4. Flip the **Voltage Selection Switch** in the High Voltage compartment to the right for **115 Vac** operation (Figure 2). 115 should now be visible on the switch.

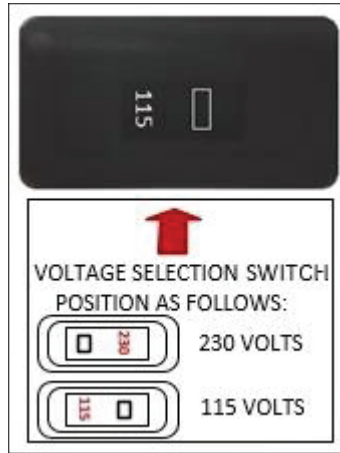

Figure 2 – Voltage Selection Switch

5. Remove the conduit plug on the side of the High Voltage Compartment.
6. Insert the power cable and use a water tight connector to seal the conduit hole (1/2" NPT thread).
7. Install the **AC** and **Ground** input wires as specified on the motor nameplate. You must connect **Line 1**, **Line 2**, and **Ground** (⊕ Green Screw) in the wiring compartment correctly and securely (Figure 3).

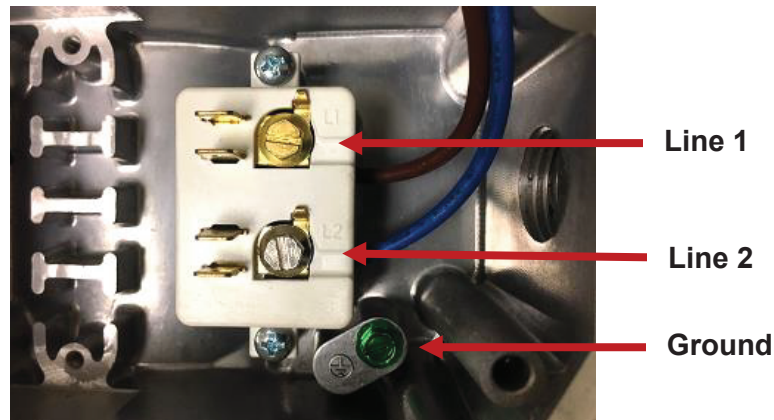

Figure 3 – AC Input Terminal Block

8. Replace the cover over the High Voltage Compartment and secure it with the three (3) hex screws.
9. Set the Wiring Compartment Cover back in place and secure it with the four (4) hex screws.
10. Apply electrical power. You can now begin programming the pump.

Motor Protections

The unit is designed to protect itself in the event of a fault situation. Fault handling is defined below:

- The drive disables power to the motor. (The motor will coast to a stop.)
- If the fault condition clears, the control attempts to restart automatically, when a valid command signal is present. For example, if an over-temp fault occurs, the control does not attempt to restart the motor until the temperature drops below the fault threshold.
- The control continues to cycle through the logic sequence indefinitely, so long as a valid command signal is present.

Low Temperature Monitor

When the control senses the ambient temperature dropping below the threshold level (as defined by the end-user), the control sends a command for the motor to run at 1200 RPM to help prevent water from freezing in the pool plumbing.

Motor Stalled

When the control detects that the rotor is locked, the motor shuts down and automatically restart when operating conditions are within specifications.

Open Output Phase

When one or more of the three phase lines between the motor and control is not connected well, the output voltage in the control is not able to reach the motor. The motor cycles through the shutdown/restart sequence the number of times indicated in the Retry Count to correct the fault condition. If that is unsuccessful, the motor stops.

Output Over Current

Motor output power is reduced until the current returns to normal operating parameters. If the motor is unable to reach normal operating current by reducing output power, the motor turns off. If the condition clears, the motor automatically restarts.

Output Over Power

The control monitors shaft output power continuously using estimated speed and torque produced by the motor shaft. The control limits the torque of the motor to maintain shaft output power below or equal to the maximum power limit. If the overload condition reduces the speed beyond the designed operating range, the motor stops.

Power Module Temperature

Motor output power is reduced until the power module temperature returns to normal operating parameters. If the motor is unable to reach normal operating temperature by reducing output power, the motor turns off. If the condition clears, the motor automatically restarts.

Under Voltage

The control turns the motor off for low voltage. When the voltage returns to acceptable operating levels the motor automatically restarts.

Hardware Protection

Fuse Protection

The unit includes fuse protection. Fuses are not user-serviceable and are intended to last the life of the product.

Inrush Protection

The inverter limits inrush current to less than 150A peak surge. The duration is less than 5ms.

Mechanical Requirements

Connections

Input power and control signals are via conduit connections. There are two compartments:

- High Voltage input power
- Low Voltage control inputs

The High Voltage Compartment has a separate cover. The High Voltage Compartment is supplied with a threaded hole for 1/2" NPT conduit connection for use with the required, sealed conduit connector and screw terminals appropriate for the voltage and current present. The terminals accommodate #12 – #14 AWG wire-size for electrical power.

Environmental Requirements

Environmental Ranges

The motor is designed for indoor or outdoor use with temperatures in the following ranges.

Type	Range
Full Shaft Output Power	0° C to 40° C (32° F to 104° F), 1.40HP 0° C to 50° C (32° F to 122° F), 1.25HP
Storage Temperature Range	-40° C to 60° C (-40° F to 140° F)
Humidity	0-99% RH (condensing)

Environmental Protection







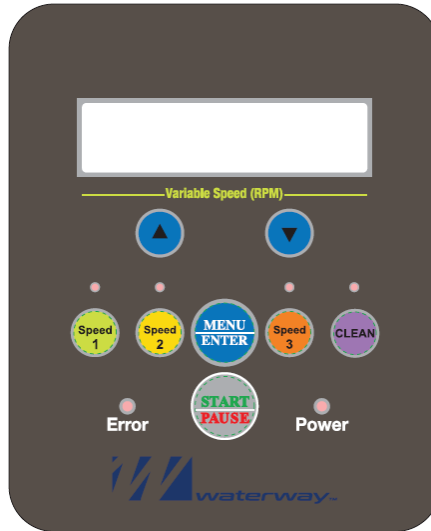



IPX5 rating

Pump Control via the User Interface

The User Interface (UI) enables you to program the operation of the pool pump motor. Generally, the buttons have two functions. **Navigation Mode** allows you to move back and forth between the different settings. **Input Mode** allows you to customize the settings and confirm your selections.



Navigation Overview









	Scroll Up – In Navigation Mode , scroll up to the previous screen. In Input Mode , increase the value of the digit in the LCD display.
	Scroll Down – In Navigation Mode , scroll down to the next screen. In Input Mode , decrease the value of the digit in the LCD display.
	Speed 1 – In Navigation Mode , there is no response. Likewise, in Input Mode , there is no response. In Run Mode , force an override using the pre-assigned Speed 1 default RPM.
	Speed 2 – In Navigation Mode , there is no response. Likewise, in Input Mode , there is no response. In Run Mode , force an override using the pre-assigned Speed 2 default RPM.
	MENU/ENTER – When the UI is unlocked, in Navigation Mode , enter a sub level menu or move to Input Mode . In Input Mode , confirm the latest setup and move back to Navigation Mode .
	Speed 3 – In Navigation Mode , there is no response. Likewise, in Input Mode , there is no response. In Run Mode , force an override using the pre-assigned Speed 3 default RPM.
	CLEAN – Pressing this button starts a 30-minute manual cleaning cycle at maximum speed, 3450 RPM (100%).
	START/PAUSE – In Navigation Mode , exit a menu and enter Standby Mode , or return to Navigation Mode from a sub menu. In Input Mode , exit a menu screen and return to Navigation Mode . In Run Mode , pause the motor.
	Error – A flashing red light indicates the motor encountered an error. Refer to the Fault Conditions section of the manual on page 27 for additional information.
	Power – A solid green light indicates the motor is powered on and functioning (running Timer cycles). A flashing green light indicates the motor has power, but is paused (not allowed to run).

Quick Start Guide













The Power Defender 140 for Waterway Variable Speed Pool Pump Motor ships with a Quick Start Guide on the inside cover of the User Interface. If the guide is missing, use the following.

QUICK START GUIDE

Set Time of Day:

1. Press  to view the settings menu and press  again to enter the Standard Settings menu.
2. Press  on the Time of Day screen to edit the hour.
3. Adjust flashing value with  or .
- Press  to confirm new hour then change minutes and AM/PM in the same way.
4. Press  to save settings and return to Time of Day screen.
5. Return to the Standard Settings menu by pressing .
6. If a custom flow schedule is not desired, press  twice to exit the settings menu and return to normal operation mode.

Set Daily Run Schedule:

1. Press  to view the settings menu.
2. Press  or  to select Custom Settings menu and  enter.
3. Use  or  to navigate the Timer 1-7 and press  to edit the displayed Timer value.
4. Adjust the flashing value with  or  and press  to confirm and adjust the next value.
5. Repeat Steps 3 and 4 until all desired Timers, Durations, and Speeds are set.
(Note: Setting the Duration to 0 deactivates the Timer).
6. Return to the Custom Settings menu by pressing .
7. Press  twice to return to normal operation mode.

Installer Information

Scan QR code
for full manuals.



Navigation with UI Buttons

When the motor is in **Standby Mode** and the UI is unlocked, pressing the **MENU/ENTER** button once cycles the motor into **Navigation Mode**. You cannot change settings while in **Navigation mode**. You can only view the setting and cycle through the menus.

- To change the settings, you must be in **Input Mode**, which you enter by pressing the **MENU/ENTER** button while on a given screen.
- After adjusting the settings, pressing the **MENU/ENTER** button again saves any changes and returns you to **Navigation Mode**.
- Pressing the **START/PAUSE** button in **Input Mode** cancels any changes you made without saving them and returns you to the related menu in **Navigation Mode**.
- In **Navigation Mode**, use the **Scroll Up** and **Scroll Down** buttons to cycle between top-level menus and sub menus. In **Input Mode**, use these buttons to increase or decrease a numeric value, or toggle a parameter On or Off.
- In **Input Mode**, the parameter in the LCD display to be adjusted will blink.
- In **Input Mode**, **MENU/ENTER** cycles the LCD cursor to the right.
- In **Input Mode**, press the **START/PAUSE** button twice to return to normal operations.
- In **Run Mode** or **Standby Mode**, the three **Speed** buttons and **Clean** execute as follows:

Button	Description
Speed 1 ^a	Force an override speed of 1350 RPM (40%).
Speed 2 ^a	Force an override speed of 1725 RPM (50%).
Speed 3 ^a	Force an override speed of 2760 RPM (80%).
Clean ^b	Start a 30-minute cleaning cycle at a speed of 3450 RPM (100%).

^aYou can adjust the RPM in a pre-configured override. Press the **Scroll Up** or **Scroll Down** button to increase or decrease the RPM in increments of 10. Press and hold either button for 2 seconds to increase or decrease RPM in increments of 100.

^bIf you press the **Clean** button followed by a **Speed** button, the motor changes the 30-minute cleaning cycle to the RPM assigned to the **Speed** button. Pressing the **Clean** button again returns the RPM of the cleaning cycle to the RPM assigned to the **Clean** button. The duration of the cleaning cycle resets with each button press.

- In **Run Mode** or **Standby Mode**, pressing **START/PAUSE** pauses the motor and cancels the override. Press **START/PAUSE** again to run the motor at the scheduled speed.

Lock the Keypad

You can lock the keypad to avoid accidental operation or unauthorized programming. With the motor in **Standby Mode**, press the **MENU/ENTER** button and hold the button down for three (3) seconds. The LCD screen flashes and displays the following message for ten (10) seconds.

Note: If the control does not detect a button press within the time frame, the request to lock the keypad is cancelled.

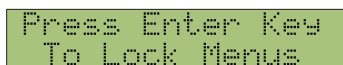

Press Enter Key
To Lock Menus

Power Defender 140 for Waterway Pool Pump Motor

Press the **MENU/ENTER** button within the time frame to confirm the operation. The LCD screen then displays the following message for two (2) seconds and returns to normal operation.



Menus Locked

When the keypad is locked, the UI displays this message any time the **MENU/ENTER** button is pressed.

Unlock the Keypad

With the motor in **Standby Mode**, press the **MENU/ENTER** button and hold the button down for three (3) seconds. The LCD screen flashes and displays the following message for ten (10) seconds.

Note: If the control does not detect a button press within the time frame, the request to unlock the keypad is cancelled.



Press Enter Key
To Unlock Menu

Press the **MENU/ENTER** button again to confirm the operation. The LCD screen displays the following message for two (2) seconds and then returns to normal operation.



Menus Unlocked

Operational States

The table below describes the operational states for the motor.

State	Description
Power On	Initialize the motor and all communication ports. The motor is ready to run.
Pause	The motor is waiting for a key press or a scheduled event to run the pump.
Run	The pump is running in response to a timer, a manual override, a manual pool cleaning, or a low temperature event.
Remote	The pump is operating under commands it receives from a central controller. The UI is bypassed in this operational state.
Fault	The pool pump motor moves into this state in response to the detection of a fault condition in either the motor or the control.
Menu Setup	Pressing the MENU/ENTER button while in Standby shifts the motor to the Menu Setup state in which the motor can be configured.
Power Loss	If the control detects a low voltage condition, it prepares the motor for a possible power loss.

Power Defender 140 for Waterway Pool Pump Motor

Menu Trees

There are two top-level menus in **Navigation Mode**: **Standard Settings** and **Custom Settings**. Sub menus under these two allow you to change system settings and customize all program Timers. The menu trees for each are outlined on the next two pages.



- Press the **MENU/ENTER** button to access the menu system.
- Press Scroll Up or Scroll Down to cycle between **Standard Settings** and **Custom Settings**.
- Press the **MENU/ENTER** button a second time to enter the top-level menu you selected.
- Press the **START/PAUSE** button to saved changes and exit **Input Mode**.

Standard Settings

Options under **Standard Settings** allow you to set the time on your motor, set temperature readings to Celsius or Fahrenheit, priming duration and speed, low temperature monitoring and threshold, remoting system monitoring, or reset configurations to default values. The following is a map of the menu tree. **Note:** By default, some menu options are not available unless the associated menu option is enabled.

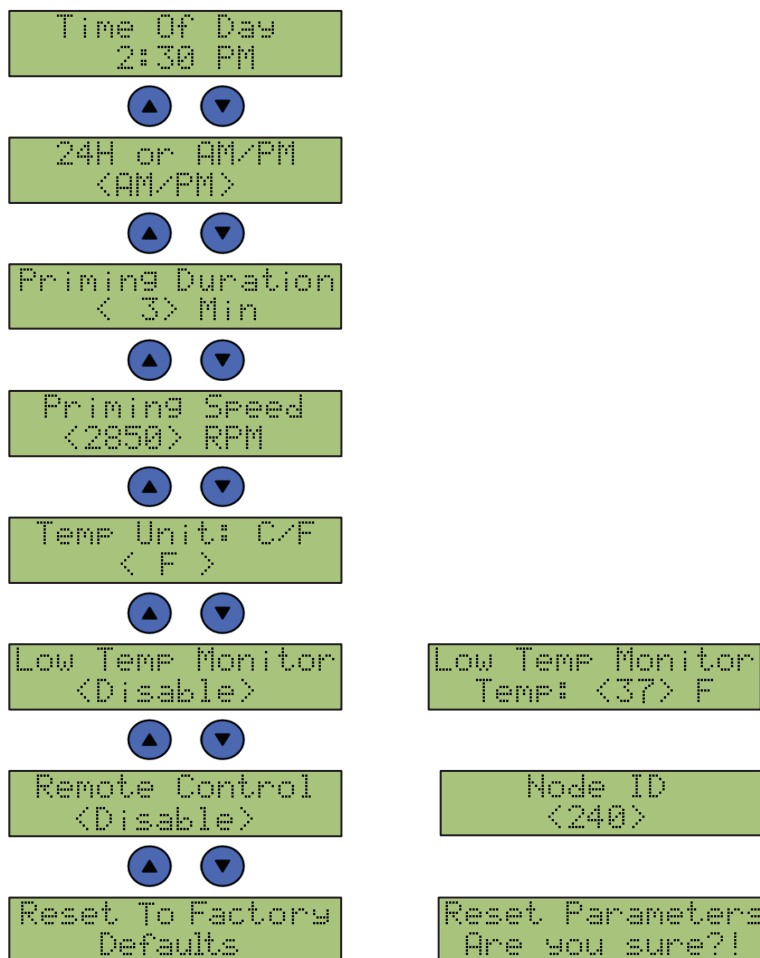

Power Defender 140 for Waterway Pool Pump Motor

Custom Settings

Configuration options under **Custom Settings** allow you to program the **Start Time**, **Duration**, and **Speed** of each Timer. You can program up to seven. The following is a map of the menu tree.

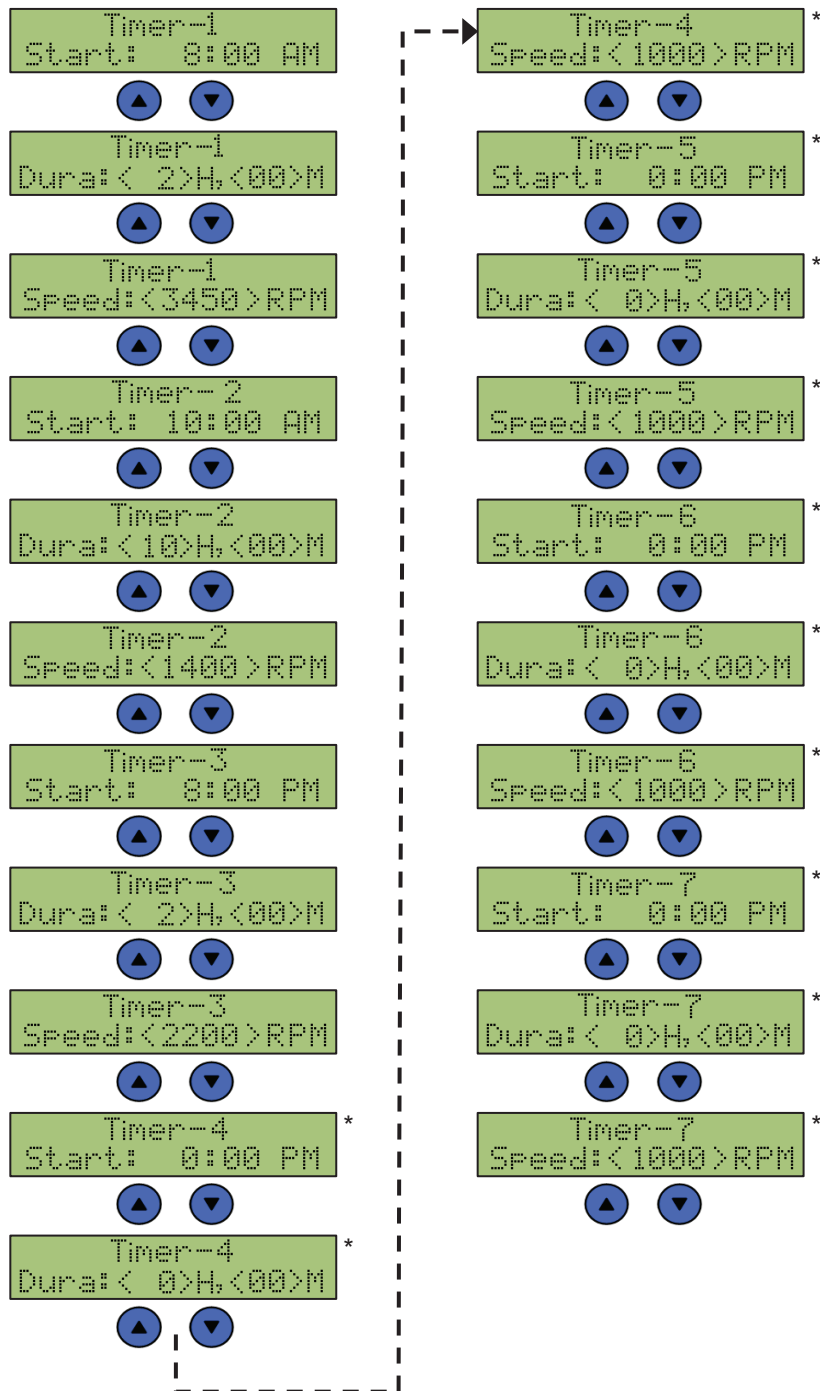

*By default, Timers 4 – 7 are deactivated. Setting a **Duration** of 0 deactivates the Timer.

Configure Your Pool Pump Motor

Begin programming the pool pump motor from the **Standard Settings** menu. The control compares the time of day you enter against programmed schedule times to determine the next pump operation.

Time Of Day

Timers 1-7 (if all are activated) are keyed to this setting.



Time Of Day
2:30 PM

Press the **MENU/ENTER** button once to enter **Navigation Mode**. Press **Scroll Up** or **Scroll Down** to select the **Standard Settings** menu tree. Press **MENU/ENTER** to enter the menu tree. Press **MENU/ENTER** again to enter **Input Mode**. Press **Scroll Up** or **Scroll Down** to adjust the field blinking in the LCD display. Press **MENU/ENTER** to cycle the edit field to the right. Press **Scroll Up** or **Scroll Down** to increase or decrease the hours, minutes, and adjust the AM/PM field. Press **MENU/ENTER** to save the changes. Press **START/PAUSE** to exit the menu option and return to the menu tree in **Navigation Mode**. Press **START/PAUSE** again to return to normal operations.

24H or AM/PM

You can configure the pump to display time in a 24-hour clock format or 12-hour AM/PM format.

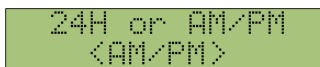

24H or AM/PM
<AM/PM>

Press the **MENU/ENTER** button once to enter **Navigation Mode**. Press **Scroll Up** or **Scroll Down** to select the **Standard Settings** menu tree. Press **MENU/ENTER** to enter the menu tree. Press **Scroll Down** until you reach the 24H or AM/PM screen. Press **MENU/ENTER** again to enter **Input Mode**. Press **Scroll Up** or **Scroll Down** to toggle the selection. Press **MENU/ENTER** to save the changes. Press **START/PAUSE** to exit the menu option and return to the menu tree in **Navigation Mode**. Press **START/PAUSE** again to return to normal operations.

Priming Duration

Pump priming functionality sets the duration time for the priming stage. The default time is three (3) minutes. Priming Duration range is from 0 to 10 minutes. A setting of zero (0) disables priming.



Priming Duration
< 3 > Min

Press the **MENU/ENTER** button once to enter **Navigation Mode**. Press **Scroll Up** or **Scroll Down** to select the **Standard Settings** menu tree. Press **MENU/ENTER** to enter the menu tree. Press **Scroll Down** until you reach the Priming Duration screen. Press **MENU/ENTER** again to enter **Input Mode**. Press **Scroll Up** or **Scroll Down** to increase or decrease the duration minutes. Press **MENU/ENTER** to save the changes. Press **START/PAUSE** to exit the menu option and return to the menu tree in **Navigation Mode**. Press **START/PAUSE** again to return to normal operations.

Priming Speed

Anytime the motor moves from a Standby state into a scheduled Timer, the control primes the pump first by running at a designated speed for the duration indicated in the Priming Duration setting. By default, the priming speed is 2850 RPM.

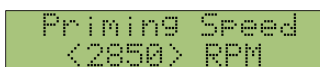

Priming Speed
<2850> RPM

Press the **MENU/ENTER** button once to enter **Navigation Mode**. Press **Scroll Up** or **Scroll Down** to select the **Standard Settings** menu tree. Press **MENU/ENTER** to enter the menu tree. Press **Scroll Down** until you reach the Priming Speed screen. Press **MENU/ENTER** again to enter **Input Mode**.

Power Defender 140 for Waterway Pool Pump Motor

Each press of the **Scroll Up** or **Scroll Down** button increases or decreases the RPM in increments of ten (10). Press and hold the **Scroll Up** or **Scroll Down** button for two (2) seconds to increase or decrease the RPM in increments of 100. Press **MENU/ENTER** to save the changes. Press **START/PAUSE** to exit the menu option and return to the menu tree in **Navigation Mode**. Press **START/PAUSE** again to return to normal operations.

Note: You cannot increase **Priming Speed** beyond the maximum allowable RPM rating for the motor, or decrease the **Priming Speed** below the minimum allowable rating.

Temp Unit

You can configure the pump to display temperature readings in Fahrenheit or Celsius.

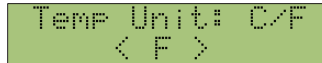

```
Temp Unit: C/F
< F >
```

Press the **MENU/ENTER** button once to enter **Navigation Mode**. Press **Scroll Up** or **Scroll Down** to select the **Standard Settings** menu tree. Press **MENU/ENTER** to enter the menu tree. Press **Scroll Down** until you reach the Temp Unit screen. Press **MENU/ENTER** again to enter **Input Mode**. Press **Scroll Up** or **Scroll Down** to toggle the temperature format. Press **MENU/ENTER** to save the changes. Press **START/PAUSE** to exit the menu option and return to the menu tree in **Navigation Mode**. Press **START/PAUSE** again to return to normal operations.

Low Temp Monitor

The control monitors the ambient temperature of the pump. If the temperature falls below a specified threshold, the pump begins cycling on and off to keep water from freezing in the pump.

If the pump is not currently running, the pump switches on for 30 minutes at 30% of the rated speed of the motor. The pump then idles for 30 minutes. If at the end of 30 minutes the temperature is still below the low temperature threshold, the cycle repeats itself. By default, this feature is disabled.

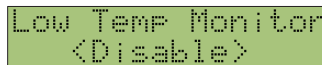

```
Low Temp Monitor
<Disable>
```

Press the **MENU/ENTER** button once to enter **Navigation Mode**. Press **Scroll Up** or **Scroll Down** to select the **Standard Settings** menu tree. Press **MENU/ENTER** to enter the menu tree. Press **Scroll Down** until you reach the Low Temp Monitor screen. Press **MENU/ENTER** again to enter **Input Mode**. Press **Scroll Up** or **Scroll Down** to toggle the setting. Press **MENU/ENTER** to save the changes. Press **START/PAUSE** to exit the menu option and return to the menu tree in **Navigation Mode**. Press **START/PAUSE** again to return to normal operations.

Low Temp Monitor

The Low Temp Monitor threshold is configurable between a range of 0° C to 10° C (32° F to 50° F).

Note: This option is not available unless you **Enable** the Low Temp Monitor setting above.



```
Low Temp Monitor
Temp: <37> F
```

Press the **MENU/ENTER** button once to enter **Navigation Mode**. Press **Scroll Up** or **Scroll Down** to select the **Standard Settings** menu tree. Press **MENU/ENTER** to enter the menu tree. Press **Scroll Down** until you reach the Low Temp Monitor threshold screen. Press **MENU/ENTER** again to enter **Input Mode**. Press **Scroll Up** to increase the digit or **Scroll Down** to decrease the digit. Press **MENU/ENTER** to save the changes. Press **START/PAUSE** to exit the menu option and return to the menu tree in **Navigation Mode**. Press **START/PAUSE** again to return to normal operations.

Remote Control

The RS-485 port allows you to connect an external controller. When connected, the UI no longer controls the motor. Commands from the external controller takes priority. Other than enabling or disabling Remote Control and possibly the Node ID, the UI plays no role in communication.

Power Defender 140 for Waterway Pool Pump Motor

Contact Waterway for the proper communication protocol. If an external controller is used, make sure the line is an isolated, non-grounded connection.



Remote Control
<Disable>

Press the **MENU/ENTER** button once to enter **Navigation Mode**. Press **Scroll Up** or **Scroll Down** to select the **Standard Settings** menu tree. Press **MENU/ENTER** to enter the menu tree. Press **Scroll Down** until you reach the Remote Control screen. Press **MENU/ENTER** again to enter **Input Mode**. Press **Scroll Up** or **Scroll Down** to toggle the setting. Press **MENU/ENTER** to save the changes. Press **START/PAUSE** to exit the menu option and return to the menu tree in **Navigation Mode**. Press **START/PAUSE** again to return to normal operations.

If **Remote Mode** is enabled and you want to return control of the pump to the UI, follow these steps.

1. Press the **Speed 2** and **Speed 3** buttons simultaneously and hold them down for five seconds. **Note:** If a button press is not detected in ten (10) seconds, the UI reverts to **Remote Mode**.



Quit Remote Mode
Are You Sure?!

2. Press **MENU/ENTER** to save the changes and return to **Navigation Mode**.

After confirming the change, the pump stops, if it is running, and moves to **Standby Mode** in which you can program the motor from the UI. The pump no longer responds to commands from the external control system. Press **START/PAUSE** to enable the run schedule.

Node ID

Node ID is used to determine whether the integrated UI or an external controller (**Remote Mode**) has ultimate command over the operation of the motor. **Note:** This option is not available unless the Remote Control setting above is Enabled.

The **Node ID** can be set to any number between 1 and 247. The default number is 240. Also, a DIP Switch can be used to set the **Node ID**, if **Remote Mode** is enabled. See **page 24** for additional information. A DIP Switch ID other than zero (0) takes priority over the **Node ID** in the UI menu. Conversely, with a DIP Switch setting of zero (0), the **Node ID** is read from the integrated UI.



Node ID
<240>

Press the **MENU/ENTER** button once to enter **Navigation Mode**. Press **Scroll Up** or **Scroll Down** to select the **Standard Settings** menu tree. Press **MENU/ENTER** to enter the menu tree. Press **Scroll Down** until you reach the Node ID screen. Press **MENU/ENTER** again to enter **Input Mode**. Press **Scroll Up** to increase the digit or **Scroll Down** to decrease the digit. Press **MENU/ENTER** to save the changes. Press **START/PAUSE** to exit the menu option and return to the menu tree in **Navigation Mode**. Press **START/PAUSE** again to return to normal operations.

Reset To Factory

This setting allows you to reset all parameters in the **Standard Settings** and **Custom Settings** menus back to the factory default settings. Refer to **page 31** for a list of the default parameters.



Reset To Factory
Defaults



Reset Parameters
Are you sure?!

Press the **MENU/ENTER** button once to enter **Navigation Mode**. Press **Scroll Up** or **Scroll Down** to select the **Standard Settings** menu tree. Press **Scroll Down** until you reach the Reset To Factory screen. Press **MENU/ENTER** again to enter **Input Mode**. The Reset Parameters screen appears. "Are you sure?!" flashes on the second line. Press **MENU/ENTER** to confirm the choice and save the changes. Press **START/PAUSE** to exit the menu option and return to the menu tree in **Navigation Mode**. Press **START/PAUSE** again to return to normal operations.

Power Defender 140 for Waterway Pool Pump Motor

Timers 1 – 7

One of the key advantages of the Power Defender 140 for Waterway is the flexibility of customizing up to seven Timers. The Timers control when the pump switches on and off throughout the day. You can customize the **Start Time**, **Duration**, and **Speed** for each. Control logic begins at the speed with the earliest start time of the day and continues running that speed until the next start time of day is reached. If the timer schedule is configured in such a way that run times overlap, the timers run in priority from Timer 1 (highest) through Timer 7 (lowest). The default schedule is as follows:

Timer #	Start Time	Duration	Speed
Timer 1	8:00 AM	2 Hours	3450 RPM
Timer 2	10:00 AM	10 Hours	1400 RPM
Timer 3	8:00 PM	2 Hours	2200 RPM
Timer 4*	12:00 AM	0 Hours	1000 RPM
Timer 5*	12:00 AM	0 Hours	1000 RPM
Timer 6*	12:00 AM	0 Hours	1000 RPM
Timer 7*	12:00 AM	0 Hours	1000 RPM

*By default, Timers 4 – 7 are deactivated. A **Duration** of **0** deactivates a Timer.

To program a Timer, press the **MENU/ENTER** button once to enter **Navigation Mode**. Press **Scroll Up** or **Scroll Down** to select the **Custom Settings** menu tree. Press **MENU/ENTER** to enter the menu tree. Press **Scroll Down** until you reach the Timer you want to program. Press **MENU/ENTER** again to enter **Input Mode**. The following example uses **Timer 1**. The process is the same for each.

```
Timer-1
Start: 8:00 AM
```

On the Timer Start screen, press the **MENU/ENTER** button to enter **Input Mode**. Press **Scroll Up** to increase the hour or **Scroll Down** to decrease the hour. Press **MENU/ENTER** to cycle the edit field to the right. Press **Scroll Up** to increase the minutes or **Scroll Down** to decrease the minutes. Press **MENU/ENTER** to save the changes. Press **START/PAUSE** to exit the menu option and return to the menu tree in **Navigation Mode**. Press **START/PAUSE** again to return to normal operations.

```
Timer-1
Dura: < 2>H,<00>M
```

Press **Scroll Down** until you reach the screen for the Timer Duration. Press the **MENU/ENTER** button to enter **Input Mode**. Press **Scroll Up** to increase the hour or **Scroll Down** to decrease the hour. Press **MENU/ENTER** to cycle the edit field to right. Press **Scroll Up** to increase the minutes or **Scroll Down** to decrease the minutes. Press **MENU/ENTER** to save the changes. Press **START/PAUSE** to exit the menu option and return to the menu tree in **Navigation Mode**. Press **START/PAUSE** again to return to normal operations.

```
Timer-1
Speed: < 3450>RPM
```

Press **Scroll Down** until you reach the Timer Speed screen. Press the **MENU/ENTER** button to enter **Input Mode**. Each press of the **Scroll Up** button increases the RPM in increments of 10. Likewise, each press of the **Scroll Down** button decreases the RPM in increments of 10. Press and hold the **Scroll Up** button continuously increases the RPM in increments of 100. Press and hold the **Scroll Down** button continuously decreases the RPM in increments of 100. Press **MENU/ENTER** to save the changes. Press **START/PAUSE** to exit the menu option and return to the menu tree in **Navigation Mode**. Press **START/PAUSE** again to return to normal operations.

Overriding a Timer

You can override the speed and flow rate programmed into **Timers 1 – 7** (if all timers are activated) without having to re-program the pump. Simply press one of the **Speed** buttons. Here is the pre-programmed speed and flow rate for each.

Button	Description
Speed 1	Force an override speed of 1350 RPM (40%).
Speed 2	Force an override speed of 1725 RPM (50%).
Speed 3	Force an override speed of 2760 RPM (80%).

You can also adjust the RPM within the override. Press the **Scroll Up** or **Scroll Down** button to increase or decrease the RPM in increments of 10. Press and hold either button for 2 seconds to increase or decrease RPM in increments of 100.

The effect of the button press depends on whether the pump is currently running a Timer or standing by to execute the next Timer on the schedule.

With the Pump in Run Mode

When the pump is running a Timer, pressing the **Speed 1**, **Speed 2**, or **Speed 3** button forces an override of the Timer currently under way. The motor begins running at the pre-programmed RPM assigned to the button for the remaining duration of the flow.

Note: Pressing the **START/PAUSE** button will pause the motor.

- This action also cancels the override.
- Pressing **START/PAUSE** again will un-pause the motor. However, the motor then resumes operation at the speed associated with the original Timer, not that of the **Speed** button.

With the Pump in Standby Mode

When the motor is on standby and not waiting for a Timer, pressing **Speed 1**, **Speed 2**, or **Speed 3** enables a quick start run. In this case, the motor runs at the RPM assigned to the speed button until the **START/PAUSE** button is pressed.

When the motor is standing by and waiting for the next scheduled Timer, pressing **Speed 1**, **Speed 2**, or **Speed 3** forces an override of the next scheduled Timer. At the time of the next scheduled activity, the motor cancels the RPM associated with the Speed button pressed and runs the pre-programmed RPM assigned to the schedule.

Note: Pressing the **START/PAUSE** button pauses the motor.

- This action also cancels the override.
- Pressing **START/PAUSE** again will un-pause the motor. However, the motor will not run as the motor is in a standby state, waiting to execute the next Timer on the schedule.
- When the next Timer begins, the motor executes the Timer at the speed you assigned when programming the UI, not the RPM of the **Speed** button.

Wiring a Remote Connection

You can attach any RS485-compatible cable to the RS485 connector.

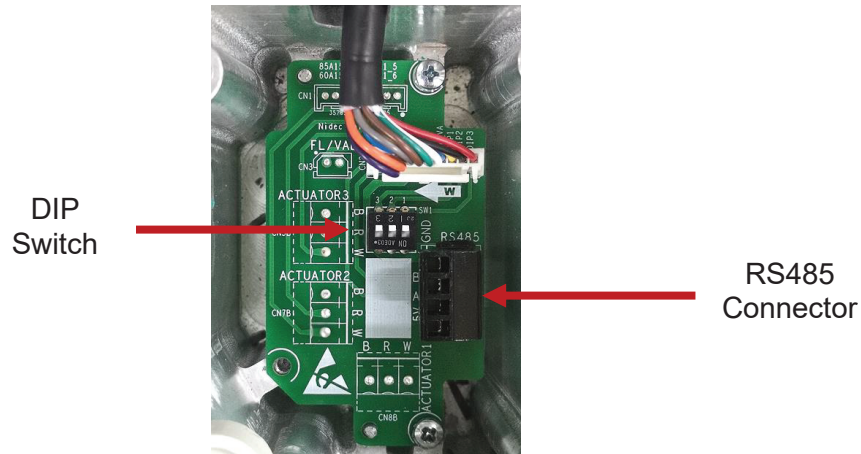

The drive interface board is located in the Low Voltage Compartment and is powered by an isolated, low voltage, 5 Vdc electrical power supply. Follow these steps to wire a remote connection:

1. Remove the four (4) slotted head hex washer screws securing the Wiring Compartment Cover. Set the cover aside.
2. Remove the conduit plug and feed the RS485 cable (not supplied) through the 1/2" NPT conduit hole on the end of the compartment.
3. Attach the cable to the RS485 Connector to the interface board.

The 3-position DIP Switch on the interface board can be used to identify a specific MODBUS ID. A DIP Switch ID other than zero (0) takes priority over the **Node ID** menu in the integrated UI. **Note:** Configuring MODBUS communications assumes that you are familiar with the MODBUS RTU protocol. The MODBUS ID settings on the DIP Switch are as follows:

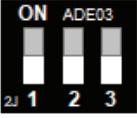
DIP 1	DIP 2	DIP 3	Function	DIP Switch
OFF	OFF	OFF	MODBUS ID (default)	 (default)
OFF	OFF	ON	MODBUS ID 1	
OFF	ON	OFF	MODBUS ID 2	
OFF	ON	ON	MODBUS ID 3	
ON	OFF	OFF	MODBUS ID 4	
ON	OFF	ON	MODBUS ID 5	
ON	ON	OFF	MODBUS ID 6	
ON	ON	ON	MODBUS ID 7	

To activate remote control of the pool motor, ensure that you have also enabled the Remote Control setting via the UI. See the Remote Control setting on **page 20** for more information.

Troubleshooting

This troubleshooting guide provides field technicians a step-by-step process for accurately diagnosing and troubleshooting certain problems experienced by the Power Defender 140 for Waterway pool motor.

This section however does not override or replace instructions suggested by the manufacturer of the pump system. To prevent misdiagnosis and unneeded repairs, operators should try the steps listed in the Basic Troubleshooting section first. If a problem still exists or there is an ongoing issue after following the steps in the Basic Troubleshooting section, then move to the General Troubleshooting section for further guidance.



Installation, operation, and maintenance must be performed by qualified personnel. Familiarization with and adherence to the National Electrical Code (NEC), National Fire Protection Association (NFPA) standards, and to local codes are required. It is important to observe safety precautions to protect personnel from possible injury.

- Code requirements differ from state to state. Install equipment using qualified electricians in accordance with the applicable codes and ordinances in your area and in accordance with the NEC. All electrical connections should be made and maintained by a qualified or licensed electrician.
- Always disconnect electrical power at the fuse box or circuit breaker panel before handling electrical connections or performing maintenance on this unit. Allow the motor to come to a complete stop and wait two (2) minutes. This allows the capacitors to discharge any residual voltage.



- Wear safety glasses to inspect the equipment while it is running or while working on equipment.

Basic Troubleshooting

Motor shaft is not spinning or runs abnormally

- Verify that the pump should be running, based on the time of day and how you have the sequence of Timers programmed in the pump.
- Check the circuit breaker for trips or accidental shutoff.
- Verify that the signal cable and electrical power leads are securely connected to the control connectors. Inspect for shorts, detached wiring, or loose connections.

Motor rattles or makes excessive noise

- Inspect the motor for accumulated dirt and debris, or other signs of damage.
- Inspect the motor for secure mounting to the system chassis.
- Inspect the screws on the Wiring Compartment Cover and the High Voltage Compartment Cover. Verify that they are securely tightened.
- Inspect the shaft; verify that the shaft is not bent and that the motor shaft spins freely in both directions.

General Troubleshooting

Symptom	Possible Cause	Corrective Action
Motor fails to start.	Incorrect voltage to the motor	Verify that the motor voltage to the terminals matches the nameplate voltage requirements. Choose the correct voltage position on the Voltage Selection Switch.
	Improper terminal connections	Turn OFF power. Verify that connections are per the terminal connection section of this manual.

Symptoms	Possible Cause	Corrective Action
Motor does not come up to full speed.	Low voltage	Verify that the motor voltage under load to the terminals matches the nameplate voltage requirements.
Motor stalls during operation.	Overloaded motor	With electrical power disconnected, verify that the pump rotates freely.
	Low voltage	Verify that the motor voltage under load to the conduit box connection terminals matches the nameplate voltage requirements.
	Breaker trip	The interruption of power due to a current breaker trip indicates a current overload to the circuit beyond the rating of the breaker(s). Use a qualified electrician to make sure the breaker(s) rating is properly sized to the motor current rating based on the National Electrical Code.
Motor vibrates or is excessively noisy.	Pump	Before taking any corrective actions, ensure that the electrical power is OFF . Check the pump to ensure it is properly connected to the motor shaft. Check the pump impeller for damage. Make sure there are no foreign objects inside pump.
	Motor base (if applicable)	Verify that the motor base (if applicable) is not cracked and that the four mounting bolts are tightened securely.
Motor is not operating properly.	Command signal	Check the command signal to ensure that it is above the Start Threshold. Check line voltage.

Fault Conditions

The motor is designed to protect itself in the event of a fault condition. Should the motor encounter a fault, the Error light on the integrated UI illuminates and the LCD displays basic information related to the problem. Fault conditions are of two general types.

- **Self-Clearing (SC)** – You cannot cancel a Self-Clearing fault condition. The source of the fault must be corrected before the fault is cleared from the UI display. For example, if a module over temperature fault is detected, the module temperature must decrease to an acceptable level before the fault clears. The **Retry Count** on a self-clearing fault cannot be reset by the user.
- **Not Self-Clearing** – Fault conditions that are not self-clearing will retry a set number of times at specified intervals. After all retry attempts are exhausted, the motor will stop. If the fault condition permits a **User Reset** of the **Retry Count**, pressing **Start/Pause** resets the **Retry Count** back to zero (0) and allows the motor to attempt running again.

E 0 – Overcurrent (HW)

Self-Clearing (No), Retry Count (15), Retry Delay (12 Seconds), User Reset (Yes)

Motor phase current is the input current enabling the pump to run at or under a specified speed or torque. Phase current over the peak threshold will trigger an Overcurrent (HW) fault. The pump will shut down and restart automatically. Then, the motor will cycle through the shutdown/restart sequence the number of times specified in the Retry Count to correct the fault condition. At the end of the sequence, if the fault has not corrected itself, the motor will not restart.

The fault condition can be triggered by the motor, the control, or the pump system. Press the **Start/Pause** button to clear the fault from the LCD display. Then, press any **Speed** button to restart the motor. The retry sequence will start over. If the fault continues to occur, contact your pool professional or a qualified electrician for service.

E 1 – Low Voltage

Self-Clearing (Yes), Retry Count (15), Retry Delay (12 Seconds), User Reset (No)

The voltage to the motor/control terminals must be either 115 or 230 Vac, (depending on the option you set with the Voltage Selection Switch) +/- 10 percent, 60 or 50 Hertz. A sustained input voltage significantly below the chosen voltage setting will cause a Low Voltage trip to occur.

When the fault occurs, the pump will shut down and automatically restart when operating conditions are within specifications. The pump will cycle through the shutdown/restart sequence the number of times specified in the Retry Count to correct the fault condition.

When the input voltage returns to a normal state, the fault automatically clears and the motor restarts. If the fault continues to occur after verifying input line voltage is correct, contact your pool professional or a qualified electrician for service.

E 4 – Hot Power Module

Self-Clearing (Yes), Retry Count (0), Retry Delay (0 Seconds), User Reset (No)

The power module is an integrated circuit in the motor control. Software in the control continuously monitors the temperature of this component. If the temperature in the power module exceeds a specified threshold, the motor stops in order to prevent the power module from overheating and causing damage to the motor.

After the temperature in the power module drops below the threshold number, the pump automatically restarts and clears the fault from the LCD display.

E 5 – Open Phase

Self-Clearing (No), Retry Count (50), Retry Delay (12 Seconds), User Reset (Yes)

An open phase indicates that one or more of the three phase lines between the motor and control is not connected securely, or that there is an open circuit in the motor winding phase. Output voltage in the control is not able to reach the motor. The pump cycles through the shutdown/restart sequence the number of times specified in the Retry Count to correct the fault condition. If that is unsuccessful, the motor stops.



- Always disconnect electrical power at the fuse box or circuit breaker panel before handling electrical connections or performing maintenance on the motor. Allow the motor to come to a complete stop and wait two (2) minutes. This allows the capacitors to discharge any residual voltage.
- The control unit on the motor contains hazardous voltage.

Remove the cover to the High Voltage Compartment. Refer to **Steps 1 – 2** in Wiring the Motor on **page 9**. Verify that the wiring connections are correct and securely tightened. Replace both compartment covers. Refer to **Steps 7 – 9** on **page 10**.

Press the **Start/Pause** button to clear the fault from the LCD display. The retry sequence will start over. Then, press any **Speed** button to restart the motor. If the fault continues to occur after verifying the wire connections, contact your pool professional or a qualified electrician for service.

E 8 – MC EE Error

Self-Clearing (No), Retry Count (50), Retry Delay (12 Seconds), User Reset (Yes)

This fault indicates that an error occurred in the memory area of the chip used to store software information needed to run the motor. For some reason, the software was unable to read key values from memory.

Press the **Start/Pause** button to clear the fault from the LCD display. The retry sequence will start over. Then, press any **Speed** button to restart the motor. If the fault continues to occur after verifying the wire connections, contact your pool professional or a qualified electrician for service.

E 11 – MC Comm Lost

Self-Clearing (Yes), Retry Count (0), Retry Delay (0 Seconds), User Reset (No)

The motor somehow lost communication with the integrated User Interface. When that happens, the pump shuts down.



- Always disconnect electrical power at the fuse box or circuit breaker panel before handling electrical connections or performing maintenance on the motor. Allow the motor to come to a complete stop and wait two (2) minutes. This allows the control bus capacitors to discharge any residual voltage.
- The control on the motor contains hazardous voltage.

Remove the cover from the Voltage Compartment. Refer to **Steps 1 – 2** in Wiring the Motor on **page 9**. Verify that the wiring connectors on the circuit board are securely fastened. Replace the compartment cover. Press any **Speed** button to restart the motor. If the fault continues to occur after verifying the wire connections, contact your pool professional or a qualified electrician for service.

E 12 – UI Key Stuck

Self-Clearing (No), Retry Count (0), Retry Delay (0 Seconds), User Reset (Yes)

The **Start/Pause** button is stuck. If that should happen, the motor shuts down. Press the **Start/Pause** button to see if you can release it. If the fault continues to occur after verifying the wire connections, contact your pool professional or a qualified electrician for service.

E 13 – UI EE failure

Self-Clearing (No), Retry Count (0), Retry Delay (0 Seconds), User Reset (No)

This fault indicates that an error occurred in the memory area of the chip used to store User Interface parameters when configuring the pump. For some reason, the software was unable to read the values from memory.

Power down the motor. Press any **Speed** button to restart the pump. If the fault continues to occur after powering up the motor, contact your pool professional or a qualified electrician for service.

E 16 – Motor Stalled

Self-Clearing (No), Retry Count (50), Retry Delay (12 Seconds), User Reset (Yes)

This fault indicates that the rotor is locked. When the software detects a locked rotor, the motor automatically shuts down and restarts. The pump cycles through the shutdown/restart sequence the number of times specified in the Retry Count to correct the fault condition.

A locked rotor may be caused by an accumulation of dirt or debris in or around the motor causing the impeller to jam. Refer to the **Maintenance** section on **page 30** for steps you can take.



- Always disconnect electrical power at the fuse box or circuit breaker panel before handling electrical connections or performing maintenance on the motor. Allow the motor to come to a complete stop and wait two (2) minutes. This allows the control bus capacitors to discharge any residual voltage.

Press the **Start/Pause** button to clear the fault from the LCD display. The retry sequence will start over. Then, press any **Speed** button to restart the motor. If the fault continues to occur after a maintenance inspection, contact your pool professional or a qualified electrician for service.

Maintenance



Before performing any maintenance on the pump, disconnect electrical power. Allow the motor to come to a complete stop and wait two (2) minutes. This allows the bus capacitors in the control to discharge any residual voltage.

- Periodically inspect the installation. Check for dirt accumulation, unusual noises or vibration, overheating, worn or loose couplings, high motor amps, poor wiring or overheated connections, loose mounting bolts or guards, and worn motor starter contacts. Check all wiring harnesses and control connectors. Inspect for shorts, detached wiring, or loose connections.
- Remove any debris accumulation, particularly in and around vent openings by vacuuming. Dirt or debris accumulation can jam the impeller, cause motor overheating, and is also a fire hazard.
- **Do not** use solvents! Some solvents may attack motor insulation, finish, or bearing lubricants. Solvents are highly flammable.
- Ball bearing motors are permanently lubricated. No maintenance is required.

Lowering Your Utility Costs

Your electric bill is based on the number of Kilowatts used in a typical billing cycle. Each Kilowatt is 1,000 watts. To calculate how much energy your current pool motor is using and to calculate the savings potential your pool pump motor, visit our web site and use the [Energy Calculator](#).

(<http://www.usmotors.com/PoolEnergyCalc>)

The calculator uses US Dollars (USD) for savings calculation only. The calculator will show you how many hours to run your pump each day, along with the appropriate speed for maximum energy savings. Contact your utility company to determine peak demand times of day or the times of day during which higher utility costs are charged to the customer. Then, program your motor either not to run at all, or to run at very low RPMs during these periods.

Example Calculations

By reducing your speed to 50% RPM, the horsepower requirement is reduced to 1/8th of the 100%. The calculation is as follows:

$$(50/100 * 50/100 * 50/100) = .125 \text{ or } 12.5\%.$$

To run the pump at 30% RPM, the calculation is as follows:

$$(30/100 * 30/100 * 30/100) = 0.027$$

This would be 2.7% of the previously used Max HP. Lower utility cost is a primary advantage of the Power Defender 140 for Waterway Pool Pump Motor. Try out the **Energy Calculator** to determine your energy savings by reducing the speed while enabling the proper amount of daily flow needed to filter your pool.

Default Settings

These are the factory default settings for each of the configurable parameters. The default values listed below are based on AM/PM equivalents, not the 24H clock setting. You can reset the pool pump motor to the default settings by enabling **Reset To Factory** located in the **Standard Settings** menu tree.

Standard Settings	Value	Units
Time Of Day	-	
24H or AM/PM	AM/PM	
Priming Duration	3	Minutes
Priming Speed	2850	RPM
Temp Unit	F	
Low Temp Monitor	Disable	
Low Temp Monitor	37°	F
Remote Control	Disable	
Node ID	240	Numeric
Reset To Factory	-	

Custom Settings	Value	Units
Timer 1 Start	8:00 AM	
Timer 1 Duration	2	Hours
Timer 1 Speed	3450	RPM
Timer 2 Start	10:00 AM	
Timer 2 Duration	10	Hours
Timer 2 Speed	1400	RPM
Timer 3 Start	8:00 PM	
Timer 3 Duration	2	Hours
Timer 3 Speed	2200	RPM
Timer 4 Start*	12:00	
Timer 4 Duration*	0	Hours
Timer 4 Speed*	1000	RPM
Timer 5 Start*	12:00	
Timer 5 Duration*	0	Hours
Timer 5 Speed*	1000	RPM
Timer 6 Start*	12:00	
Timer 6 Duration*	0	Hours
Timer 6 Speed*	1000	RPM
Timer 7 Start*	12:00	
Timer 7 Duration*	0	Hours
Timer 7 Speed*	1000	RPM

*By default, Timers 4 – 7 are deactivated. A **Duration** of **0** deactivates the Timer.

Power Defender 140 for Waterway Pool Pump Motor

Warranty Information

LIMITED WARRANTY

Nidec Motor Corporation (NMC) extends the following LIMITED WARRANTY to the purchaser and to its customers (collectively referred to as the "Purchaser") of the enclosed motor and components: the motor and components are free from defects in materials and workmanship under normal use, service and maintenance FOR A PERIOD OF 18 MONTHS FROM THE DATE OF ORIGINAL PURCHASE FROM NMC OR THE NMC DEALER/RETAILER, NOT TO EXCEED 30 MONTHS FROM THE DATE OF MANUFACTURE BY NMC. THE FOREGOING WARRANTY IS THE ONLY WARRANTY GIVEN AND NO OTHER WARRANTY IS PROVIDED, EXPRESS OR IMPLIED, INCLUDING WITHOUT LIMITATION, MERCHANTABILITY OR FITNESS FOR A PARTICULAR PURPOSE. Certain aspects of disclaimers are not applicable to consumer products, i.e., motor and components acquired by individuals and used for personal, family or household purposes (as distinguished from industrial or other purposes). Some states do not allow limitations on how long an implied warranty lasts, so the above limitation may not apply to you. This warranty gives you specific legal rights, and you may have other rights which vary from state to state.

Certain repairs or services are the responsibility of the Purchaser and the Purchaser is expected to pay for them. This warranty does not extend to any losses or damages due to misuse, accident, abuse, neglect, negligence, unauthorized modification or alteration, use beyond rated capacity, or improper installation, maintenance, application or use, including, without limitation, use in a manner contrary to the accompanying instructions or applicable codes.

If within thirty (30) days after Purchaser's discovery of any warranty defects within the above stated warranty period, Purchaser notifies NMC or the dealer from whom the motor was purchased in writing, NMC shall, at its option and as Purchaser's exclusive remedy, repair or replace or refund the purchase price for that portion of the motor and components found by NMC to be defective. Failure by Purchaser to give such written notice within the applicable time period shall be deemed an absolute and unconditional waiver of Purchaser's claim for such defects. Purchaser must write or call the dealer from whom the motor was purchased for directions regarding the shipment of the motor, with freight prepaid by the Purchaser, to an authorized service location for warranty service. If Purchaser is unable to contact the dealer to obtain sufficient instructions regarding the handling of the motor, Purchaser should write NMC at the address below, giving the motor model number, the dealer's name, address and number of dealer's invoice; and describing the nature of the alleged defect. Arrangements for warranty service will then be made by NMC.

If the motor is damaged in transit, Purchaser should file a claim directly with the carrier.

IN NO EVENT, REGARDLESS OF THE FORM OF THE CLAIM OR CAUSE OF ACTION (WHETHER BASED IN CONTRACT, INFRINGEMENT, NEGLIGENCE, STRICT LIABILITY, OTHER TORT OR OTHERWISE), SHALL NIDEC'S LIABILITY TO PURCHASER OR ITS CUSTOMER EXCEED THE PRICE PAID BY PURCHASER FOR THE SPECIFIC MOTOR OR OTHER GOODS PROVIDED BY GIVING RISE TO THE CAUSE OF ACTION. IN NO EVENT SHALL NIDEC'S LIABILITY TO PURCHASER OR ITS CUSTOMER EXTEND TO INCLUDE INCIDENTAL CONSEQUENTIAL OR PUNITIVE DAMAGES. WITH RESPECT TO CONSUMER PRODUCTS, SOME STATES DO NOT ALLOW THE EXCLUSION OR LIMITATION OF INCIDENTAL OR CONSEQUENTIAL DAMAGES, SO THE ABOVE LIMITATION OR EXCLUSION MAY NOT APPLY TO YOU.

© 2019 Waterway Plastics. All rights reserved.
Waterway™ is a trademark of Waterway Plastics.

For more information

2200 East Sturgis Road | Oxnard, California 93030

Phone: 805-981-0262

FAX: 805-981-9403

<https://waterwayplastics.com>

