

## MODEL AF STEP ENTRY SYSTEM c/w GATE



**IMPORTANT INSTRUCTIONS:** Read all instructions carefully & completely to become familiar with parts, assembly, safety and proper use of this product. Failure to follow these instructions may result in serious personal injury. **DO NOT DEVIATE FROM THESE INSTRUCTIONS & PLEASE REVIEW WITH ALL USING THIS POOL ENTRY SYSTEM**

**TOOLS REQUIRED:** 7/16" socket or nut driver, measuring tape, level, Phillips (star) screwdriver, utility / trimming knife, a 5/16", 1/4" & 1/8" drill bits & drill and a pad lock

### SAFETY INSTRUCTIONS & PROPER USE

- This pool entry system has a 300 lb load capacity - one person - when properly installed
- The entry is designed and intended for use with an above ground pool only (flat bottom)
- Your above ground pool has shallow water - absolutely **NO DIVING** or **NO JUMPING** into the pool
- The entry system with gate conforms to all requirements of the APSP, ANSI & ICC recommended standards for above ground/on ground swimming pool steps (when properly assembled & installed as per manufacturer's recommendations)
- For entry & exit of the pool face steps at all times. Use extended handrails at all times for additional safety
- This step system includes a protecting gate - **NEVER** use entry system without gate attached and fully functional. When pool is not in use the gate **MUST** be securely closed, latched and locked at all times to prevent entry, injury or drowning
- Ensure the bottom of the side support stringers are free of debris & any possible sharp edges as not to damage the pool liner. Use of a ladder or step pad (sold separately) is highly recommended for extra protection & life of the pool liner
- Locate pool steps on a solid / flat base both inside & outside pool. Do not use entry system with "dished" bottom pools
- **IMPORTANT:** Entry system **MUST** be secured to pool structure for stability and safety - follow all instructions closely
- Keep all handrails, platform and treads free from obstructions to avoid possible injury. Do not secure any items to the pool entry. Such objects (eg. thermometers, toys, ropes) may create a potential for tripping or entrapment & injury can occur
- **NEVER ALLOW CHILDREN TO SWIM UNATTENDED** - Nothing replaces parental supervision at all times
- Assemble and install this pool entry system as per the manufacturer's instructions. Do not deviate from these instructions as serious personal injury or drowning may occur - **PLEASE ALWAYS SWIM SAFELY & RESPONSIBLY !**
- Please review all instructions for proper use and safety with all individuals using this pool entry system to prevent injury

#### Step 1: IDENTIFY PARTS



Top Platform - 1 pc

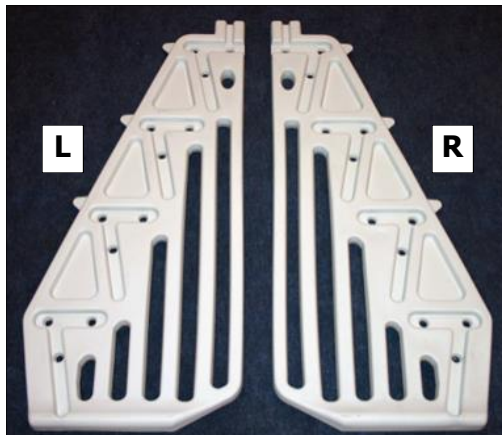

Stringers - 4 pcs - 2 Left & 2 Right



Gate - 1 pc



Gate Hinges (inner & outer)  
2 sets  
Gate Stop - 1 pc



Latch Shield  
1 pc

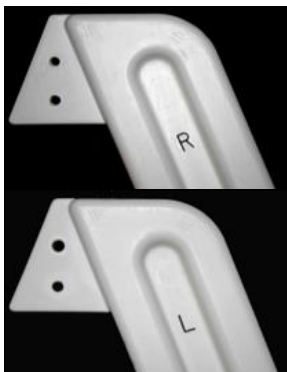

Upper Handrails - 4 pcs  
2 Left & 2 Right



Lower Handrails - 4 pcs  
2 Left & 2 Right

#### TREAD - RISERS



24" Tread-Riser - 4 pcs  
(without light hole)



24" Tread-Riser - 2 pc  
(with light hole)



24" Half Btm Riser - 2 pc



24" Half Top Tread - 2 pc

**Step 2:  
IDENTIFY HARDWARE**



**NOTE:** the hardware for the gate assembly is packaged separately within the master hardware package - please set it aside for the gate

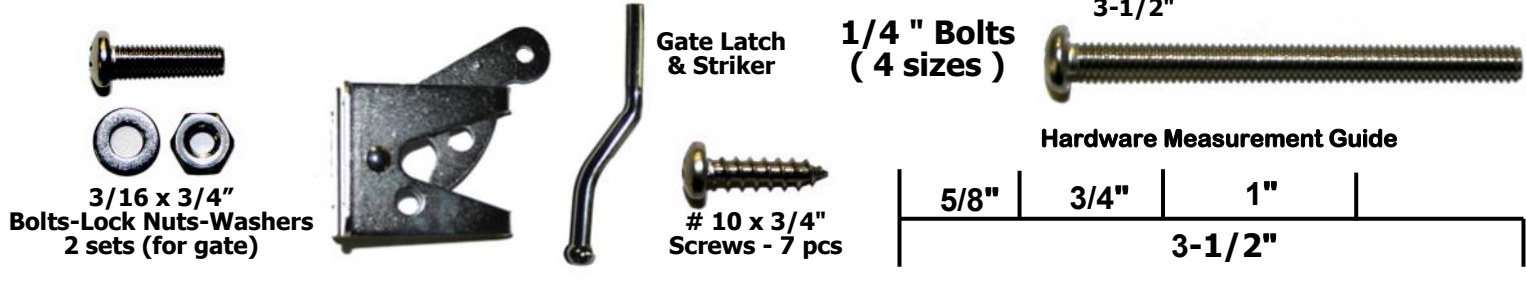

**Step 3: FIT TREADS & RISERS INTO STRINGERS**



Each of the tread riser parts is hollow and contains air. When manufactured, the tread risers have small holes pierced in them so when the fully assembled step is placed within the pool the air can escape and the internal cavities will fill with water. This prevents the steps from wanting to float in the pool. However, it does take time. If you wish to speed this process up and ensure your steps will fill with water faster, you can drill an additional small hole (1/4") in the **ends** of the tread risers (all parts) as shown in Detail 3.1 above

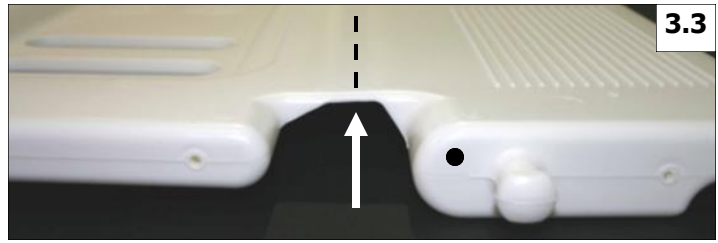
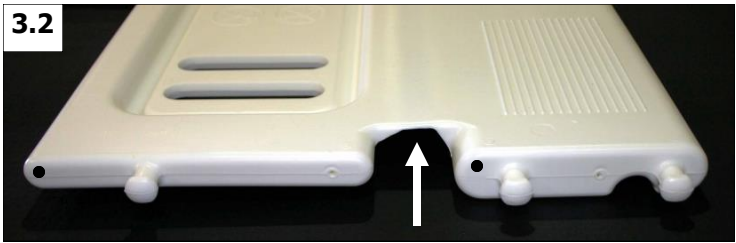

Each of the full tread risers is designed and manufactured to fold down the "center line" (indicated above in Details 3.2 & 3.3 with arrows). The plastic material used in the manufacture of these parts is very flexible, however, temperature is an important factor on how easily they will fold. The colder the material the harder it will be to fold the parts. **HINT:** if you heat the entire "center line" of the tread risers they will fold much easier. Using hot water, a heat gun or hair dryer or even laying the parts in the direct sunlight will soften the plastic and allow them to fold easily. Make certain not to overheat the plastic - it can permanently mark or damage the parts

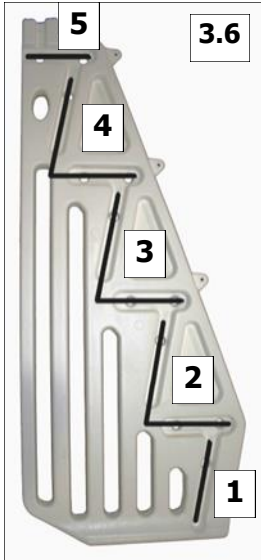

The fit and positioning of the treads and risers into the stringers is very specific. Each of the stringers has indentations with holes which the ends of the treads and risers fit and lock into. The treads and risers have button lock knobs on the ends which fit through the holes of the stringers and lock each part in place. Lay one right ( R ) stringer on a flat surface with the indentations facing up (Detail 3.4 & 3.5). The proper positioning of all treads and risers is outlined in Detail 3.6 & 3.7. Review this layout for correct positioning of all parts

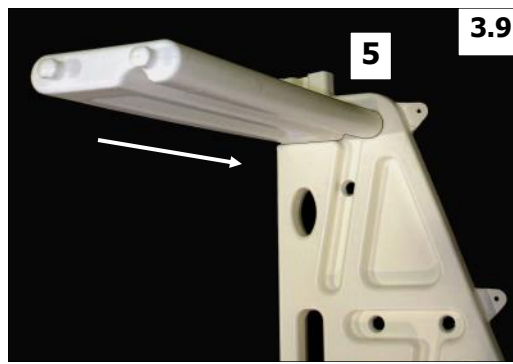
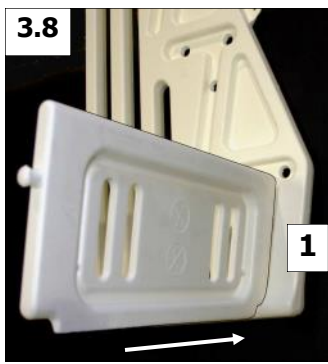
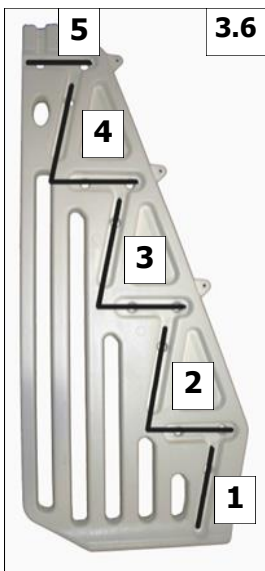

Identify one of the half bottom riser parts. With the warning signs facing out, away from the steps, fit the bottom riser into the indentation of the stringer at **POSITION 1** (see Detail 3.6 & 3.8). Press the bottom riser into the stringer until the button lock knob on the end protrudes through the hole and locks the part in place (see Detail 3.10). Identify one of the half top tread parts. With the anti-skid surface facing up, fit the top tread into the indentation of the stringer at **POSITION 5** (see Detail 3.6 & 3.9). Press the top tread into the stringer until the button lock tabs on the end protrude through the holes and locks the part in place (see Detail 3.10)

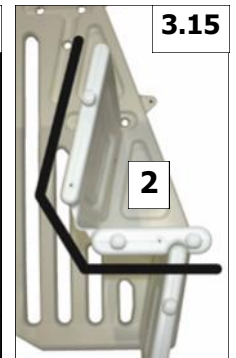
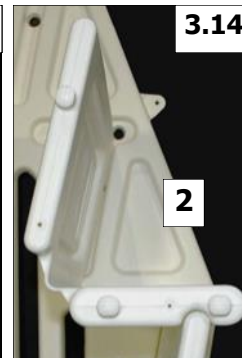
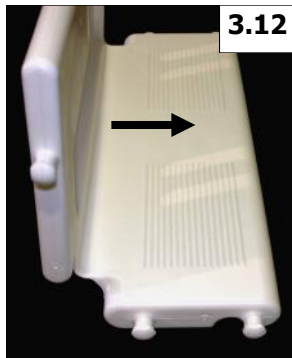
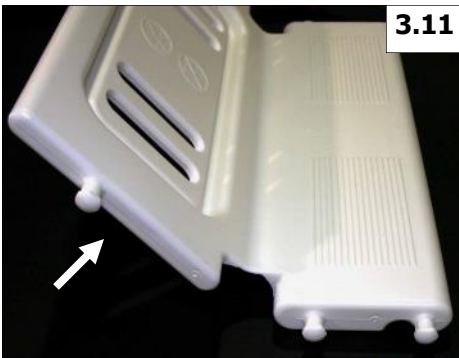

Identify one of the tread-riser parts (without light hole) and lay it on a flat surface. Holding the tread portion in place, fold the riser portion over (see Details 3.11 - 3.13). Make certain to fold warning signs on riser portion toward anti-skid surface of tread portion. You can over fold until portions touch as they will want to go back to their original position once you let go. Take the folded tread-riser and fit it into the indentations of the stringer at **POSITION 2** (see Detail 3.6, 3.14 & 3.15). **Note:** the tread portion with two button lock knobs will fit into the horizontal indentation in the stringer just above the half bottom riser already installed. The riser portion will fit into the next indentation above it. Press the tread-riser into the stringer until the button lock knobs on the ends protrude through the holes and lock the part in place (see Detail 3.10). Similarly, take the tread-riser with light hole, fold the part and insert it into indentations at **POSITION 3**. Take the last tread-riser (without light hole) and complete the assembly of the treads and risers. Make certain all button lock knobs secure parts in place



#### Step 4: FIT OPPOSITE STRINGER & ADD WEIGHT

With all treads & risers securely installed into the right stringer, position a left stringer (Detail 4.1 & 4.2). Similarly, the indentations in the left stringer fit over the ends of the treads and risers; align the button lock knobs with the holes in the stringer & press the stringer down locking all parts together. Make certain all knobs are locked through stringer holes (see Detail 3.10). Stand completed step assembly upright (Detail 4.3). The top of the stringers, where the upper handrails fit within, are open to the internal hollow cavities. One side of the pool entry requires additional weight for ballast & to prevent the step from floating. Put approximately 10-15 lbs of clean gravel into both the left & right stringer. This will give one half of the step system the required stability within the pool. Repeat for the assembly for the second step system but **DO NOT** add weight

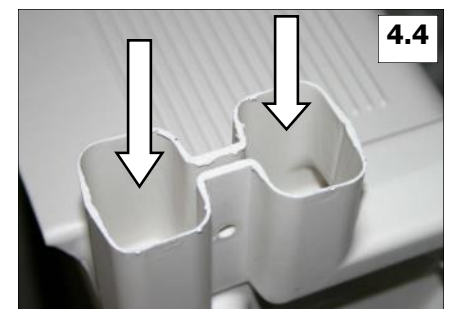

**FOLLOW ALL ASSEMBLY INSTRUCTIONS FOR A SAFE AND STABLE POOL STEP SYSTEM. USE OF A STEP PAD IS HIGHLY RECOMMENDED**

**Step 5: ASSEMBLE AND FIT UPPER HANDRAILS**

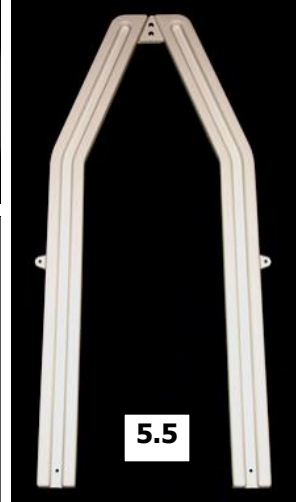

Identify the upper RIGHT (R) & LEFT (L) handrails (small stamp in parts - see Detail 5.1 & 5.2). Fit handrail pair together as shown in Detail 5.3 - 5.5 aligning bolt holes at top. Secure using 1" bolts, washers and nuts. Tighten all hardware. Repeat for both sets of upper handrails. Identify the top platform and with the anti-skid surface facing up, fit the handrail pairs through the platform as shown in Detail 5.6 & 5.7. NOTE: it is important that the correct handrails (L & R) fit through the holes in the platform as indicated. Slide the handrails up the handrail pairs. Fit the assembled handrails pairs & top platform into the top openings of each step system (see Detail 5.8 & 5.9). Make certain they are positioned properly. DO NOT secure with hardware

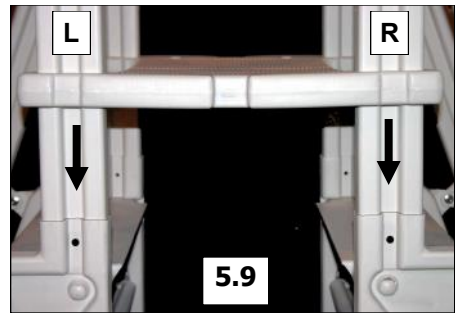
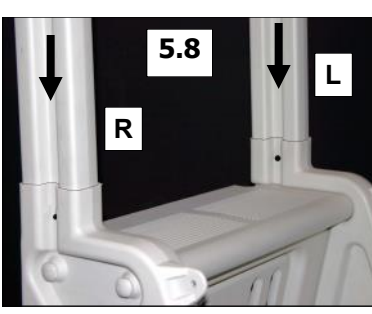
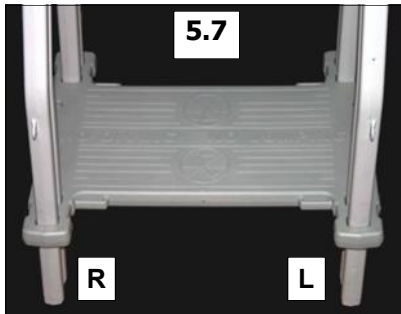
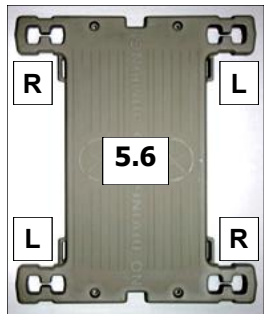

**Step 6: FIT & SECURE LOWER HANDRAILS**

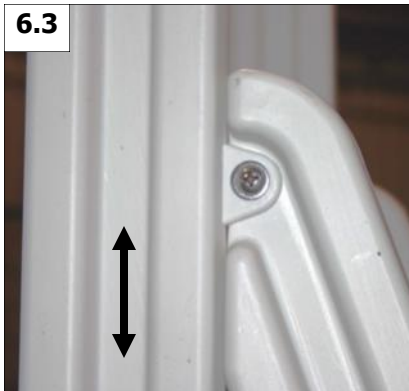

Identify the lower RIGHT & LEFT handrails (small stamp in parts - Detail 6.1). Note: both the lower left handrails have holes in the center; the holes are for connecting the gate in a later step. Facing step as if the climb, position right handrail on the right side and left on the left side. The lower handrails are to be positioned on the inside of the bolt flanges of the stringers and upper handrails. Align the bolt flanges on the handrails with the bolt flanges on the stringers and upper handrails (see Detail 6.2-6.5). When securing with hardware, it is important to start with the connection point with the upper handrail (Detail 6.3). With the lower handrail on the inside of the bolt flange, align bolt holes by sliding the upper handrail up or down (Detail 6.3). Once aligned, make certain the upper and lower handrails are perfectly aligned (Detail 6.6). Secure connection using 5/8" bolt, washer and nut. Repeat for all connection points on all lower handrails at all bolt flanges. After all lower handrails are secured, secure upper handrails with step stringers. Drill a 5/16" hole and secure using 3/4"

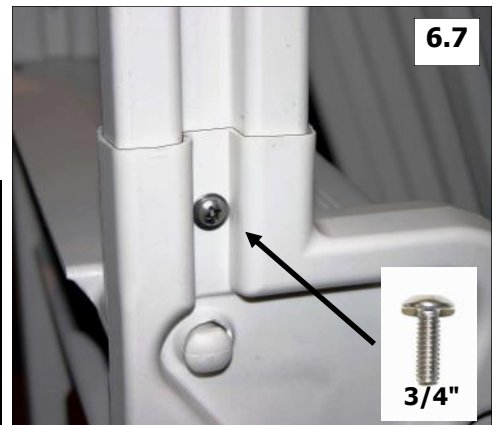
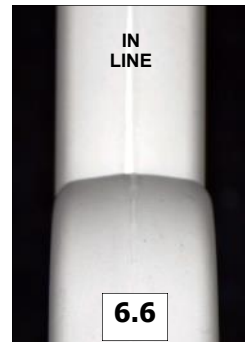

877-VINYL WK



[www.vinylworkscanada.com](http://www.vinylworkscanada.com)

**VISIT OUR WEBSITE FOR  
ADDITIONAL PRODUCT  
INFORMATION ~ WARRANTY  
REGISTRATION ~ ACCESSORIES**

**NEED REPLACEMENT PARTS ???  
ALL ARE AVAILABLE ONLINE AT  
WWW.VINYLWORKSCANADA.COM**

3/4"

**Step 7: ADJUST, MARK & SECURE TOP PLATFORM & ENTRY TO POOL**

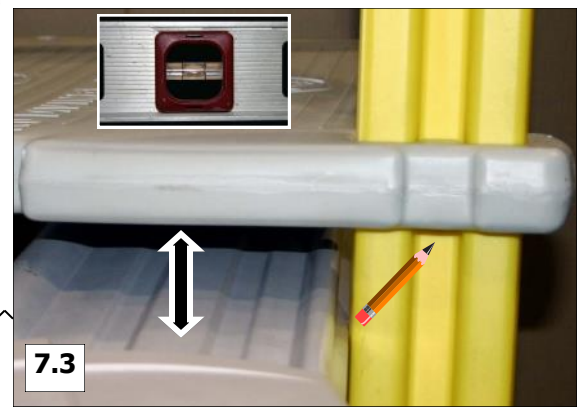
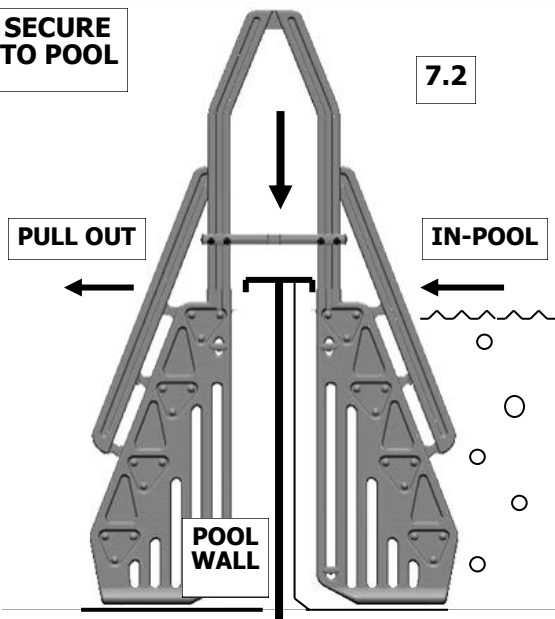
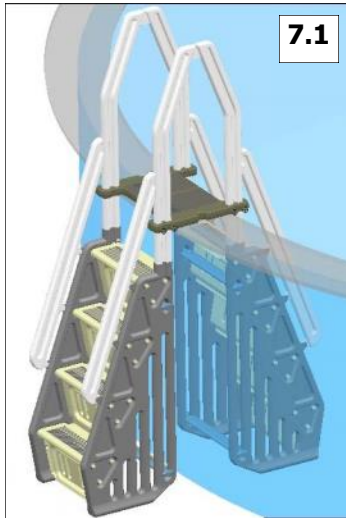

It is important before placing entry within pool that you check the bottom of the stringers for any debris or sharp edges as they may cause damage to the pool liner. Use of a step or ladder pad for extra protection is highly recommended. Place entry over pool wall at desired location (Detail 7.1). NOTE: it is important to choose a low traffic area for safety. Make certain ground outside of pool is flat and level with inside depth of pool; measure and adjust ground accordingly. With entry in place (Detail 7.2), slide top platform down toward pool top rail and pull entry out / away from pool so the in-pool portion is tight to pool wall. This reduces the space between entry and pool wall to avoid entrapment. Position top platform 1" - 1.5" above top rail of pool, **level** and mark all upper handrails where they meet the bottom of the platform (see Detail 7.3). It is important the top platform remains level when making marks. **REMOVE ENTRY FROM POOL.** Raise top platform to reveal marks on all handrails (Detail 7.4). In the **CENTER** of handrails at your marks, drill a 1/4" hole through the each handrail. Insert a stainless lock pin into each hole drilled, protruding equally on both sides of the handrail (see Detail 7.5). Push the top platform down firmly; snapping and locking it over all pins (Detail 7.6). Make certain all four corners are secured and locked into position. Reposition entry in pool at desired location. **MAKE CERTAIN THE SIDE WITH ADDED WEIGHT IS INSIDE POOL.** Similar to above, pull in-pool side of entry tight to pool top rail. Using two of the possible four bolt holes in the top platform (see Details 7.7 - 7.9), mark two hole locations of top platform onto top rail of pool. Choose two that best suit your entry position and pool top rail size. USING CAUTION, drill 1/4" holes at two marks in pool top rail (see Detail 7.10). Keep drill shavings out of pool as not to damage pool liner. Position entry appropriately over holes and secure entry in place using the 3" bolts, washer and nuts provided. Tighten hardware. Make certain entry system is stable and secure for safe climbing. **ENTRY MUST BE SECURED TO POOL FOR GREATER STABILITY & SAFETY - DO NOT USE WITHOUT SECURING TO POOL STRUCTURE / TOP RAIL - INJURY CAN OCCUR**

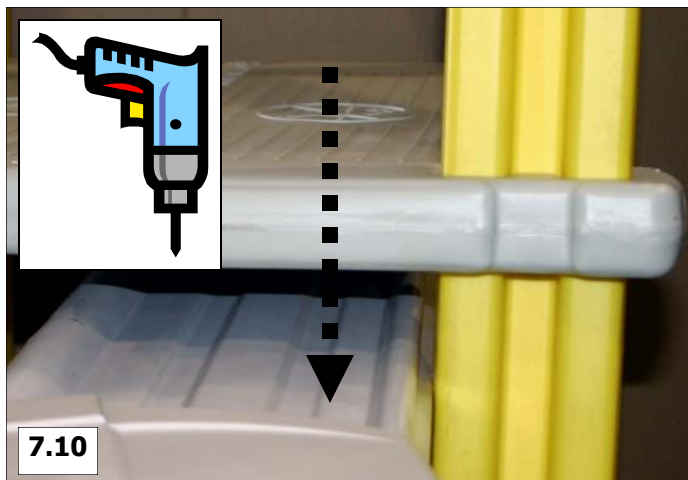
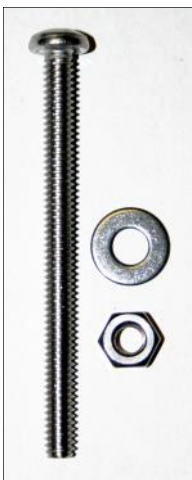
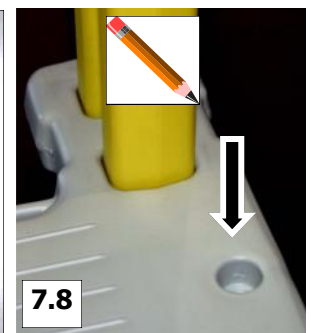
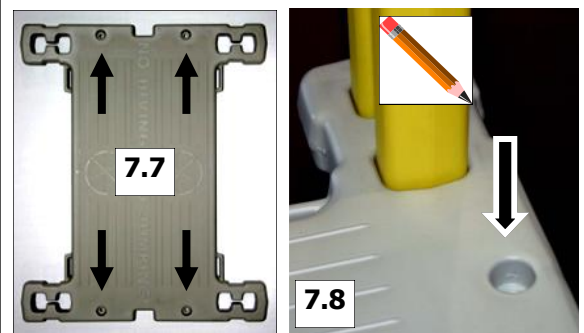
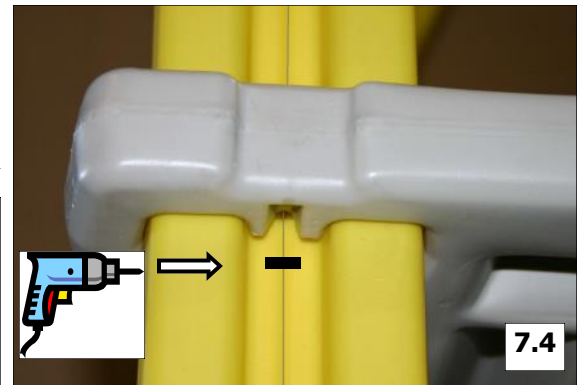

**ENTRY SYSTEM MUST BE REMOVED FROM POOL FOR WINTERIZING. REMOVE, DRAIN ALL WATER & STORE IN A SAFE PLACE UNTIL YOU REOPEN YOUR POOL THE FOLLOWING SPRING**

**BE VERY CAREFUL WHEN USING POWER TOOLS AROUND SWIMMING POOL AND WATER WITHIN - SERIOUS INJURY CAN OCCUR**

**Step 8: FIT & SECURE GATE STOP & GATE HINGE SETS**

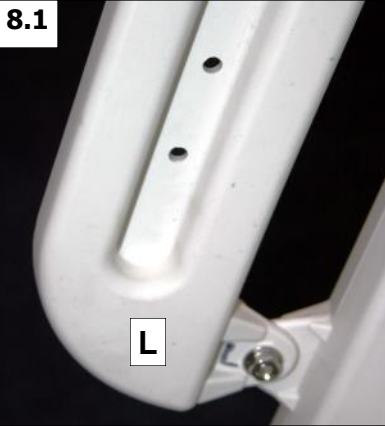

The lower LEFT handrail on the exterior portion of the entry has holes to accept the gate hinges & gate stop (Details 8.1 & 8.2). **Note:** Model AF upper hinge location stamped. Begin by securing the gate stop in place (Detail 8.3). Fit the stop on the outside face of the handrail over the **center** two holes - it is form fitting. Secure using two 3/4" bolts, washers on inside & nuts & tighten. Secure with 3/4" screw into handrail on front face (Detail 8.4). Fit the outer hinges in place around the handrail at the top and bottom hole locations (Detail 8.5 & 8.6). Likewise, they are form fitting and will snap around handrail. **HINT:** it is much easier if the outer hinge parts are heated before fitting them in place. Gently heat parts or leave them in direct sunlight so the plastic becomes more flexible and is easier to fit around handrail. The inner hinge parts fit on the inside of the handrail and align with the large on the outside (Detail 8.7). Use two 3/4" bolts, washers & nuts on the inside face and secure **LOOSELY** in the back two holes, through the handrail (only FINGER TIGHT - Detail 8.7). It is important to leave a gap between the inner & outer hinge parts so you are able to fit the gate through (see Step 9). See Detail 8.8 - 8.10 for proper placement of all gate parts

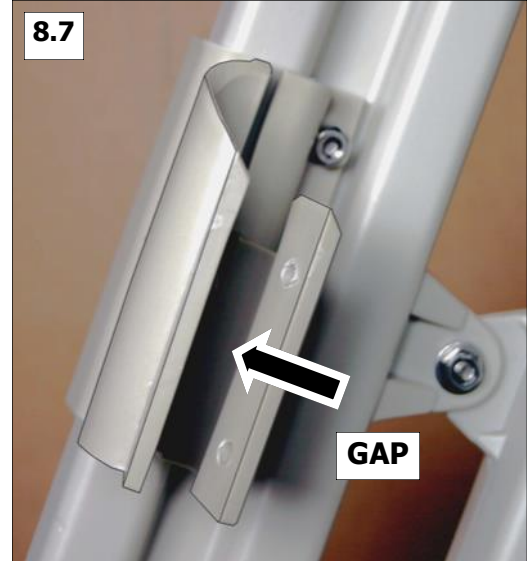
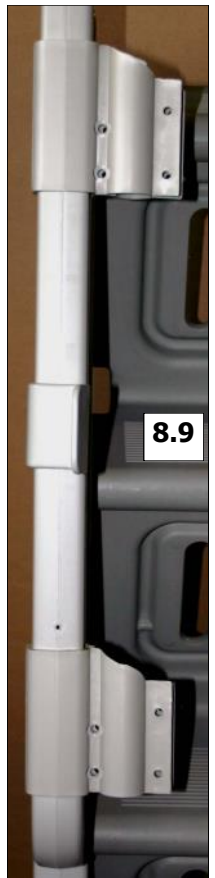
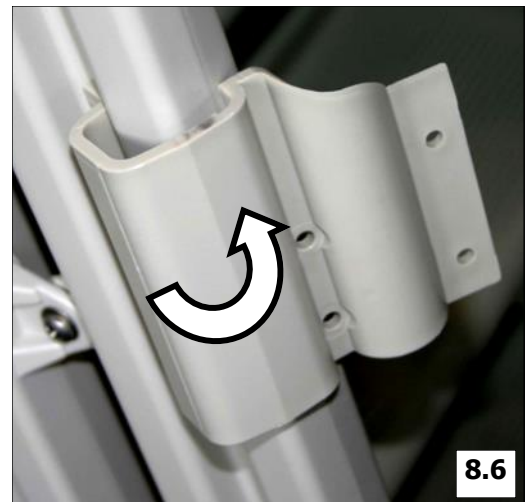
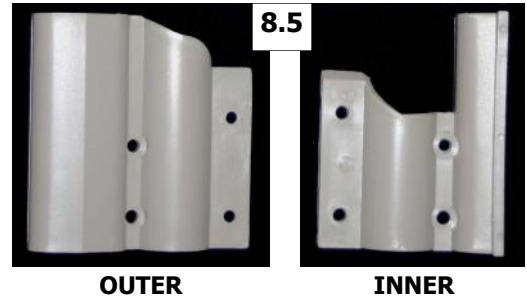

**NEVER USE ENTRY SYSTEM WITHOUT GATE ATTACHED AND FULLY FUNCTIONAL AT ALL TIMES. GATE SHOULD REMAIN LATCHED & LOCKED WHEN POOL IS NOT IN USE**

**Step 9: FIT & SECURE GATE**

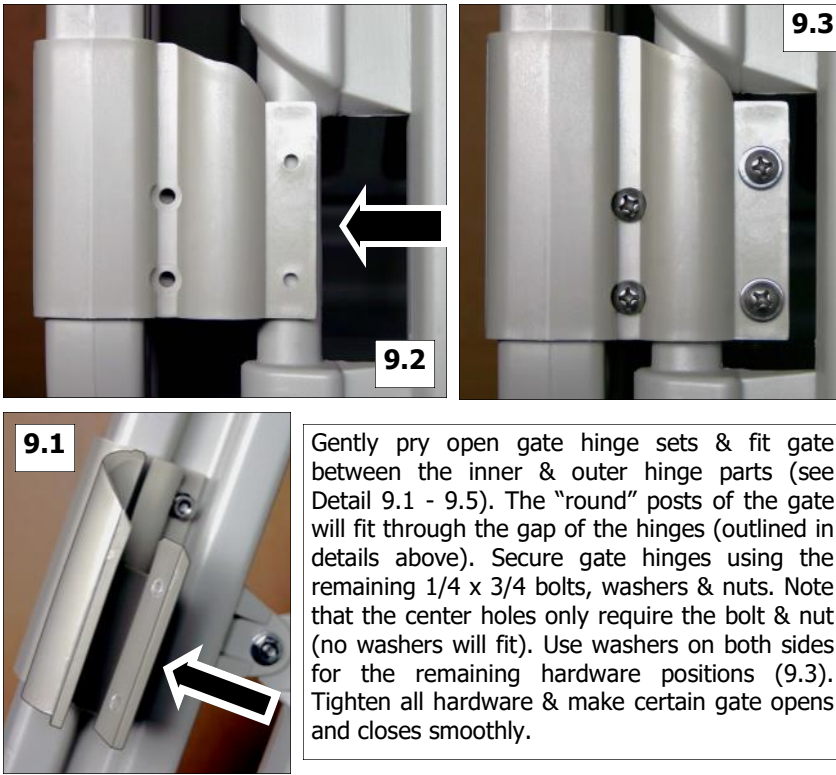

Gently pry open gate hinge sets & fit gate between the inner & outer hinge parts (see Detail 9.1 - 9.5). The "round" posts of the gate will fit through the gap of the hinges (outlined in details above). Secure gate hinges using the remaining 1/4 x 3/4 bolts, washers & nuts. Note that the center holes only require the bolt & nut (no washers will fit). Use washers on both sides for the remaining hardware positions (9.3). Tighten all hardware & make certain gate opens and closes smoothly.

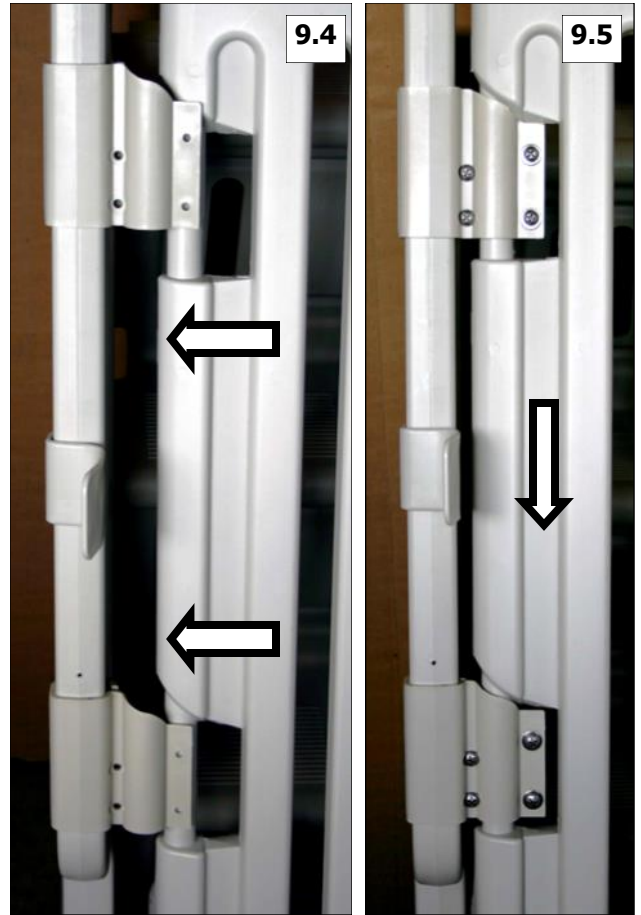

**Step 10: ATTACH GATE STRIKER BAR & LATCH**

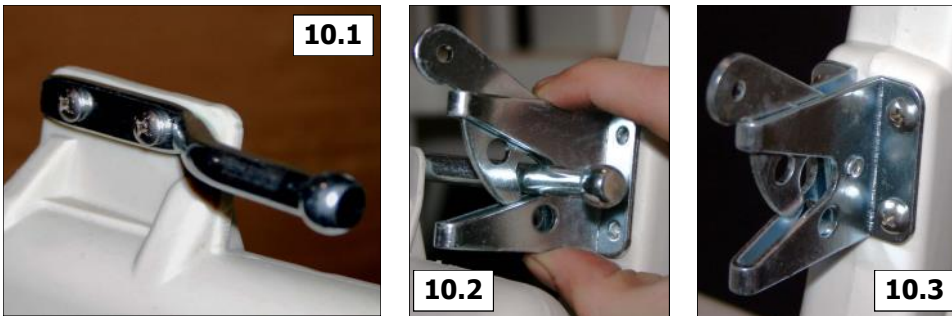

Before attaching striker bar & latch, be sure gate is closed and pushed **DOWN** within hinge sets (see Detail 9.5 above). Attach striker bar to gate (see Detail 10.1). The striker bar is to be outside of gate, angled appropriately. Secure with 3/16 x 3/4" bolts, washers inside & lock nuts. Tighten hardware. With gate closed, down entirely, & striker bar in latch; position the latch in the center of the handrail and mark holes with pencil. Make certain striker bar is centered in latch correctly & latch is closed (see Detail 10.2). Pre-drill 1/8" holes & secure using #10 x 3/4" screws (see Detail 10.3). **DO NOT** over tighten screws as plastic may strip. **Test gate to be sure it operates properly - self-closes and self-latches. LOCK GATE WHEN POOL IS NOT IN USE (10.4) - LOCK NOT INCLUDED. BE SURE TO REVIEW ALL INSTRUCTIONS FOR PROPER USE AND SAFETY WITH ALL INDIVIDUALS USING THIS POOL ENTRY SYSTEM. ALWAYS SWIM SAFELY AND REMEMBER, NOTHING REPLACES PARENTAL SUPERVISION. NEVER DEVIATE FROM THESE INSTRUCTIONS**



**ADD AN OPTIONAL IN-POOL LIGHT TO YOUR MODEL AF POOL ENTRY. ILLUMINATE AT NIGHT FOR SAFE ENTRY & EXIT OF YOUR POOL**



## GATE LATCH SHIELD FOR MODEL # CE-AF-GE-G2D ENTRY SYSTEMS

MAKE CERTAIN TO READ & FOLLOW ALL INSTRUCTIONS CAREFULLY



**Step 1: Identify all parts**

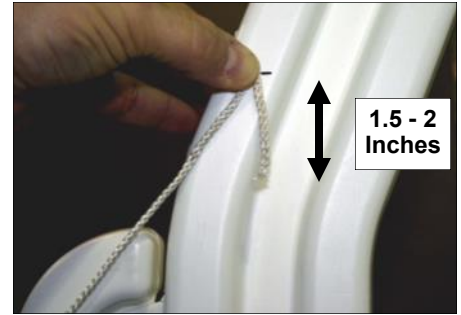
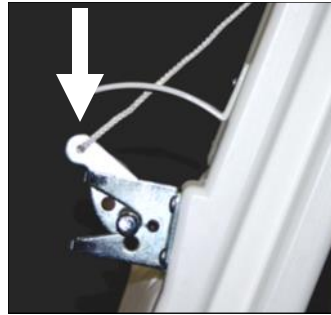

**Step 4: Make sure gate latch catch is in down / locked position over striker bar. Extend string upwards to outside face of upper handrail & fold end approx. 1.5 - 2 inches. Mark handrail at fold in string for location of eye screw (see also Step 5 below)**

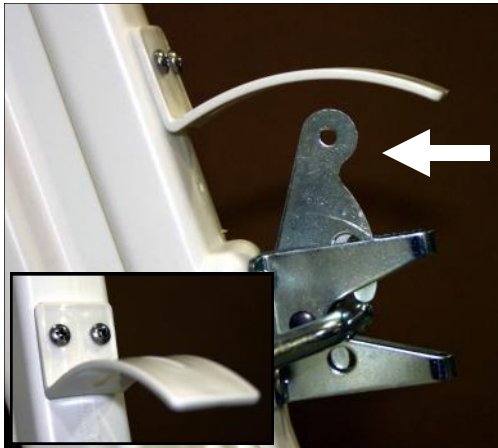

**Step 2: Position latch shield above gate latch & check that latch has room to operate properly. Center shield & secure with 2 - #10 x 3/4 screws provided**

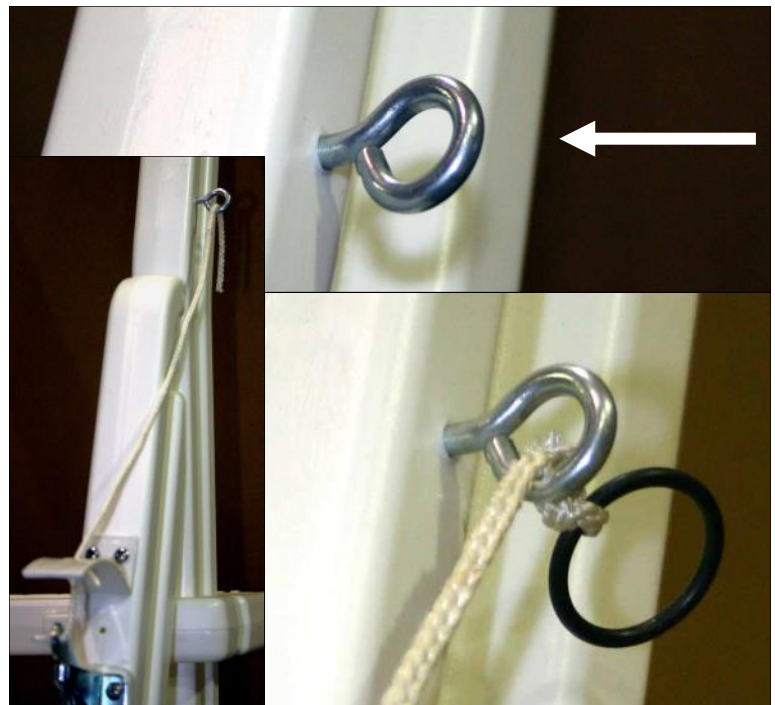

**Step 5: Screw the eye screw into the outside of the upper handrail at the mark. Do not over-tighten. Pass end of rope through eye screw & tie knot tightly around finger ring**

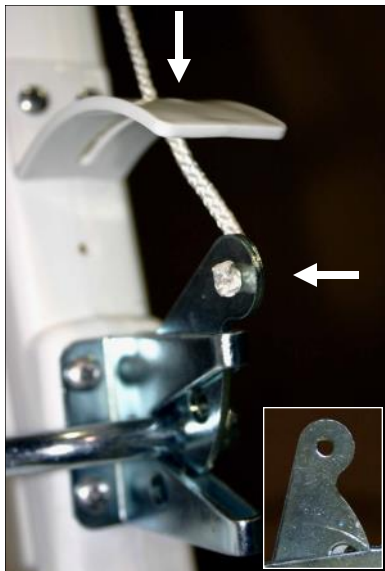

**Step 3: Pass end of rope through slot in latch shield and through hole in gate latch. Tie end of rope into a knot so pulling rope will operate gate latch**



**MAKE CERTAIN  
GATE REMAINS  
CLOSED & LOCKED  
WHEN POOL IS NOT  
IN USE. REVIEW  
PROPER USE OF  
ENTRY & GATE  
WITH ALL USERS OF  
THE POOL**

**Step 6: Pull finger ring numerous times to check for proper gate latch operation. It is extremely important that gate latch closes properly & freely over striker bar. Secure with lock**

