



IMPORTANT

OPERATING INSTRUCTIONS 
MANUAL

MEETS ASTM SAFETY STANDARD FOR POOL ALARMS

HELPFUL HINTS & TIPS

ABOVE GROUND POOL ALARM



READ THOROUGHLY BEFORE USING ALARM

This product has been designed to aid in the detection of unwanted intrusions into unsupervised pools. POOLGUARD IS A SAFETY ALARM SYSTEM AND NOT A LIFE SAVING DEVICE. "This device is not intended to replace any other safety consideration - i.e., adult supervision, lifeguards, fences, gates, pool covers, locks, etc., and some devices may not detect gradual entry."

GENERAL

POOLGUARD is the result of quality design and manufacturing techniques that are a standard at PBM Industries, Inc.; a company dedicated to high quality products. POOLGUARD is a result of that dedication and we guarantee and stand behind the POOLGUARD alarm system.

POOLGUARD is an electronic monitoring system that automatically sounds an alarm when children or pets fall into your unsupervised pool. POOLGUARD is a portable, self-contained, lightweight unit that is safe and simple to operate. Simply place POOLGUARD on the top rail of the pool. Entry into the pool will be detected by the unit's electronic sensor, triggering a loud pulsating alarm and an internal RF transmitter. A remote receiver unit will receive the transmitted signal which sounds an alarm within the home.

INSPECTION

POOLGUARD is packaged in a shipping carton that minimizes the chance of damage due to handling. Check for damage and confirm that the contents of the carton include the following items:

- POOLGUARD ALARM
- TWO QUICK SNAP POSTS & HARDWARE
- REMOTE RECEIVER AND POWER SUPPLY
- OPERATING INSTRUCTION MANUAL
- WARRANTY AND SERVICE CARDS

If an item is missing, contact either the place of purchase or PBM Industries, Inc. for replacement.

CARE AND HANDLING

POOLGUARD is constructed from sturdy plastic to withstand the adverse moisture environment of a swimming pool. **Care needs to be taken when handling your alarm and be sure to remove the alarm when the pool is being used.**

If the alarm accidentally falls into your pool, remove it immediately and drain the water from it. Take the alarm apart as indicated in the Battery Installation/Replacement and remove the battery. Remove all excess water from inside the unit and battery, and the circuit board area with a paper towel or cloth. Completely test unit before each use.

Remember to always remove the alarm from the pool before swimming.

INSTALLING YOUR ALARM

RESET/SLEEP SWITCH. (See Figure 1)

RESET: When the pool unit is installed in the pool and the horn is sounding; press the reset/sleep switch once to silence the alarm.

SLEEP MODE: When the pool unit is removed from the pool and the horn is sounding; press and hold the reset/sleep switch for 3 seconds to silence the alarm. The pool unit will automatically wake up when it is installed into the pool. **THE POOL UNIT WILL NOT GO INTO SLEEP MODE ONCE IT IS INSTALLED IN THE POOL.**

SILENT INSTALLATION AND REMOVAL FEATURE

- The poolguard system will sound an alarm (Horn will sound) when you install or remove the pool unit from your pool. If you would like the poolguard system not to sound an alarm (Horn will not sound) when you install or remove the pool unit from your pool, follow the directions below.

1. SILENT INSTALLATION (HORN WILL NOT SOUND)

- Press and hold the reset/sleep switch for 3 seconds, until you hear the pool units horn chirp. Release the reset/sleep switch, you now have 15 seconds to install the pool unit into your pool without the horn sounding. **POOLGUARD WILL INSTANTLY BE MONITORING YOUR POOL FOR AN INTRUSION.**

(Continued on next page)

SILENT INSTALLATION AND REMOVAL FEATURE (Cont.)

2. SILENT REMOVAL (HORN WILL NOT SOUND)

• Before removing the pool unit from your pool. Press and hold the reset/sleep switch for 3 seconds, until you hear the pool units horn chirp. Release the reset/sleep switch, you now have 5 seconds to remove the pool unit from your pool without the horn sounding.

IMPORTANT: THIS DOES NOT TURN POOLGUARD OFF, IF THE POOL UNIT IS NOT REMOVED IT WILL CONTINUE TO MONITOR YOUR POOL FOR AN INTRUSION.

3. POOLGUARD HAS DESIGNED THIS FEATURE FOR “ONLY” THOSE WHO HAVE THE RESPONSIBILITY OF INSTALLING OR REMOVING THE ALARM FROM YOUR POOL!

BATTERY INSTALLATION / REPLACEMENT

(Battery not included)

POOLGUARD is powered by a standard 9-volt alkaline battery. To install or replace battery:

• **IMPORTANT: WHEN A 9V BATTERY IS FIRST INSTALLED IN THE POOL UNIT, THE HORN WILL SOUND. TO SILENCE THE ALARM PRESS AND HOLD THE RESET/SLEEP SWITCH FOR 3 SECONDS. THIS PLACES THE POOL UNIT IN SLEEP MODE. THE POOL UNIT WILL AUTOMATICALLY WAKE UP WHEN IT IS INSTALLED INTO THE POOL.**

- Remove the four screws from the back of the alarm, refer to Figure 1.
- Install new battery by attaching battery snap to battery terminals; place in battery holder on inside of back plate according to the battery placement decal.
- Replace the back plate and four screws.
- To prevent possible damage, battery should be removed whenever storing the alarm for an extended period of time.

LOW BATTERY FUNCTION

The POOL UNIT AND THE REMOTE RECEIVER will beep once approximately every 20 seconds to alert you that the battery is low in the pool unit and needs to be replaced.

ABOVE GROUND POOL ALARM

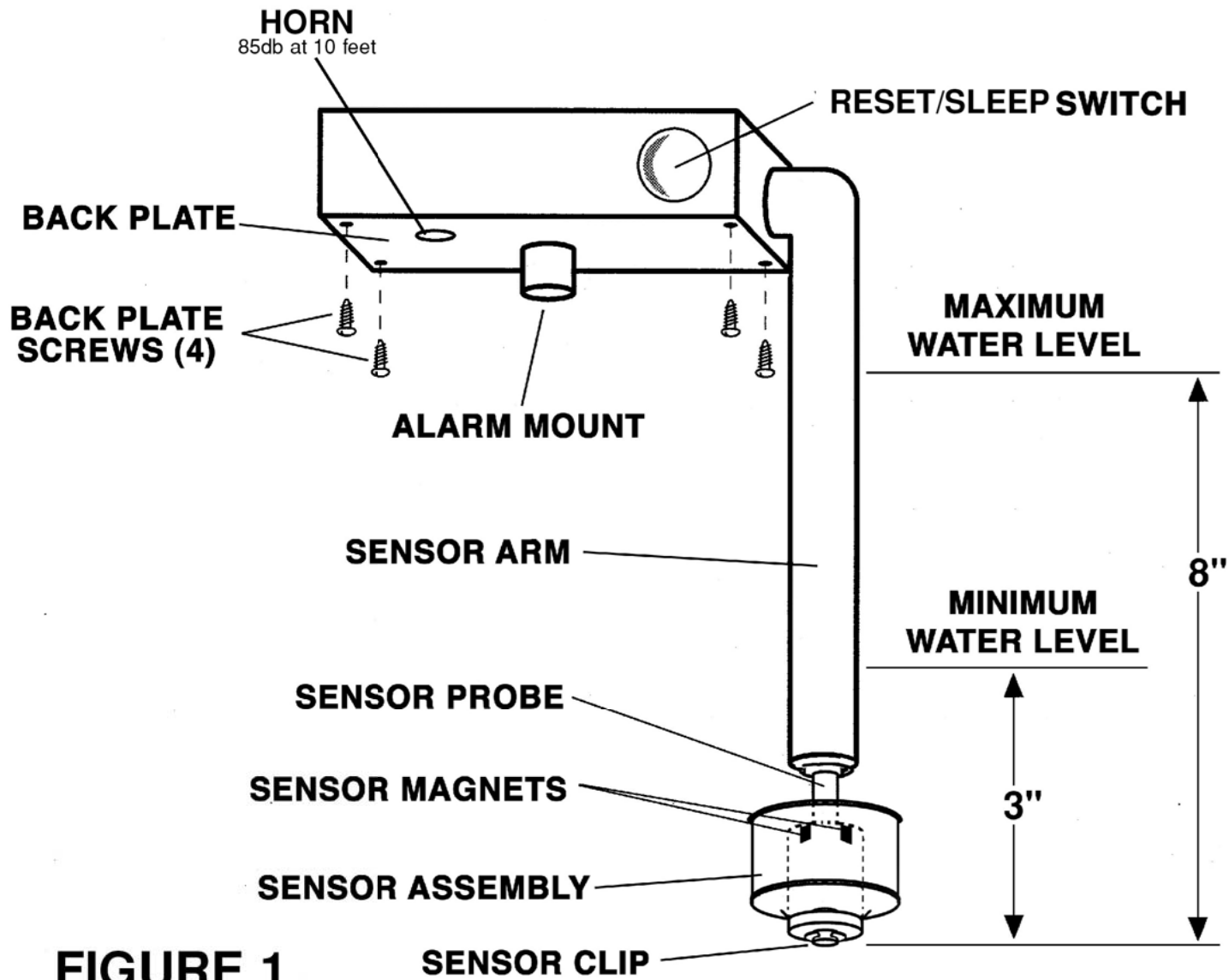

FIGURE 1

IMPORTANT

POOLGUARD may not function properly if your pool's water level is not maintained within the required levels of your alarm. Also, the unit may not operate effectively while certain types of automatic pool cleaners are in operation.

PLACEMENT IN YOUR POOL

POOLGUARD automatically compensates for variations in pool levels within the unit's operating range. The unit utilizes a sensor which projects into the water and is designed to operate in most pools with an in-wall skimmer. The sensor cannot be less than 3 inches, (See Figure 1) and not more than 8 inches into the water.

(Continued on next page)

PLACEMENT IN YOUR POOL (Continued)

•The two quick snap posts can be mounted to the vertical end cap or the top rail, See FIGURE 2. FIGURE 2 also illustrates locations best suited for detecting intrusions from any area of the pool.

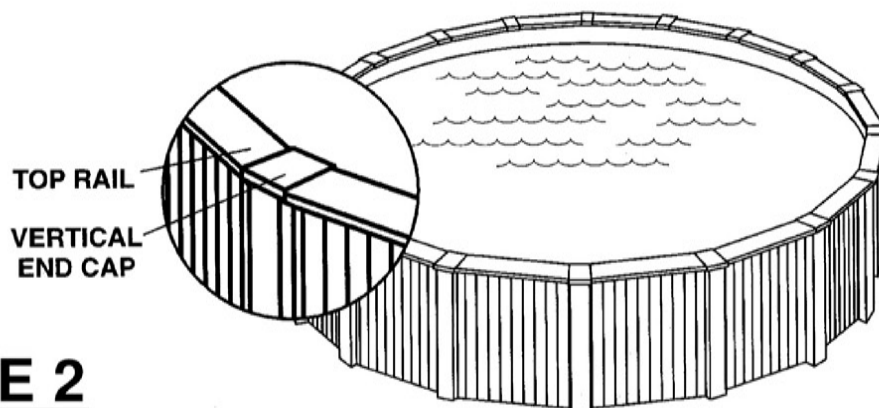
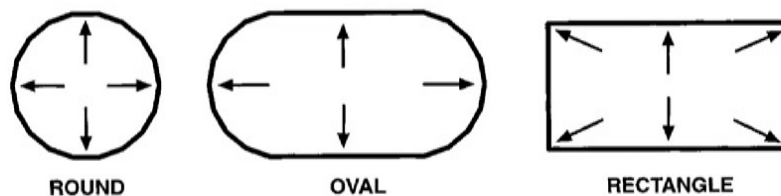

FIGURE 2



• Figure 2 illustrates locations best suited for detecting intrusions from any area of the pool. If your pool is larger than 800 square feet, if you have more than 2 return lines, any concerns about the size, or if you have an irregular shaped pool, please call customer service to clarify the recommended number of alarms and locations for alarms: 1-800-242-7163. Poolguard pool alarms have been tested and certified by ETL, to the ASTM standard specifications for pool alarms (F2208), in a 16' x 32' pool. POOLGUARD alarms can be used in pools up to 20' x 40' or 800 square feet.

•The **POOLGUARD ALARM** should not be placed too close to a pool water return line. If your return line has an eyeball fitting, this must be pointing down, see FIGURE 4.

MOUNTING QUICK SNAP POSTS

•When mounting the quick snap posts to the top rail or vertical end cap be sure they are as close to the edge as possible and set flat, this will allow the red sensor assembly to be away from the pool wall.

STANDING ON THE OUTSIDE OF THE POOL, use a 3/16" drill bit to drill your two holes for the quick snap post. See FIGURE 3. **CAUTION: IF YOU ARE USING AN ELECTRIC DRILL, KEEP AWAY FROM POOL WATER!**

Install your two quick snap posts with the hardware provided as shown in Figure 3.

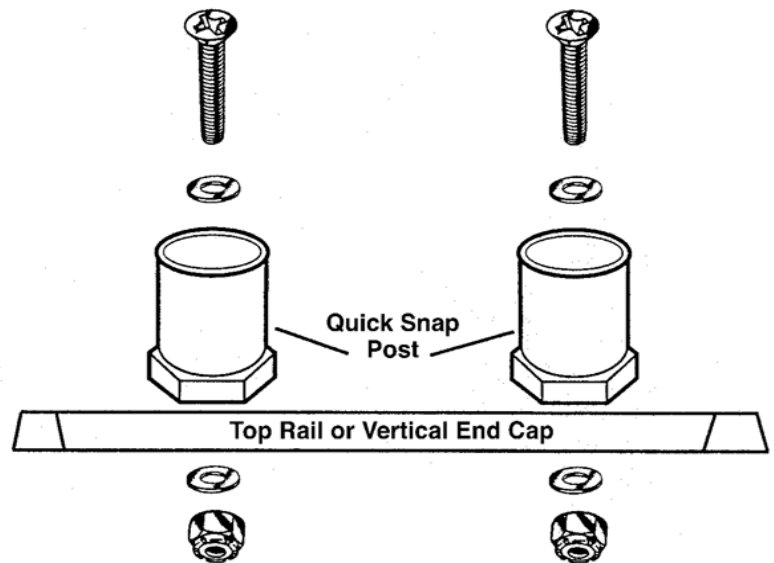

FIGURE 3

TEST BEFORE USING

To ensure effectiveness, test **POOLGUARD** every time you place it into the pool by performing the following procedure:

• **POOLGUARD DOES NOT HAVE AN ON/OFF SWITCH**

When the alarm is in the pool it is always in the **ON** position and cannot be turned off. When the alarm is out of the pool it is always in the **OFF** position.

- To test your alarm push an object of appropriate volume and weight off the top rail at the farthest location from the alarm. (A four (4) gallon jug of water or 3-one (1) gallon jugs of water tied together are ideal for testing.) The alarm should sound when the water action caused by the intrusion reaches the unit. It may take a few seconds for the alarm to react to the water action.
- After resetting the alarm and allowing time for the water action to settle, repeat the procedure from another point in the pool until you are confident of detection performance.
- **POOLGUARD** includes a timer function which automatically resets the unit after the alarm has sounded for approximately 5 minutes.

ADJUSTING YOUR RETURN LINE FITTING

The POOLGUARD unit should not be placed too close to a return line from the filter area. Water turbulence may be too strong and falsely set the alarm off. If you have more than 2 return lines please call customer service at 1-800-242-7163. It is very important in pools to adjust all the eyeball fittings on your return lines so they will not interfere with your pool alarm. It is not necessary to point your eyeball up for your pool to circulate properly. If the water is swirling on top of the pool this makes the pool too turbulent for your alarm to work properly. Point the eyeball down and your pool will still circulate properly and allow your alarm to function properly. **If you point the eyeball fitting up, your alarm may not function properly.** (See Figure 4)

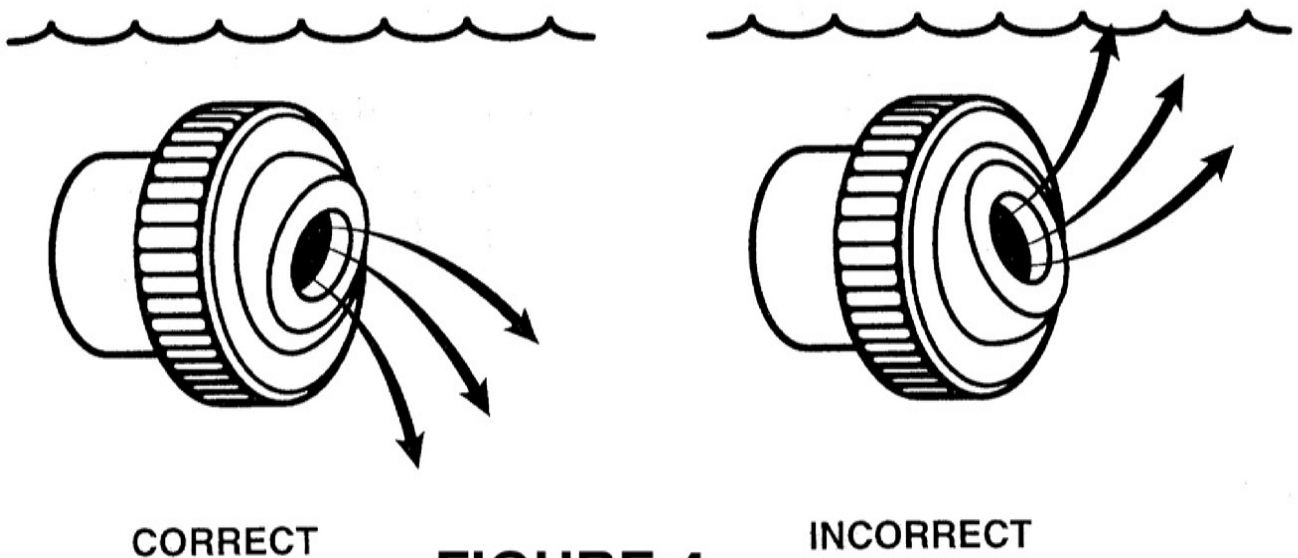

FIGURE 4

POOLGUARD REMOTE RECEIVER

The POOLGUARD REMOTE RECEIVER has been integrated with the standard POOLGUARD unit to provide a wireless remote alert operating at distances of up to 200 feet. The POOLGUARD REMOTE RECEIVER sounds an alarm in the house when the POOLGUARD unit is activated at the pool. The remote system consists of the following functional elements:

- A coded pulse receiver (Remote Receiver). Figure 5
- A standard wall outlet power supply. Figure 5

The REMOTE RECEIVER is a compact unit powered by a **UL** and **CSA** approved AC/DC power supply. The REMOTE RECEIVER can be placed on a table or a counter top inside the house. The pulse coded radio frequency signal is transmitted from the pool unit and is received and decoded to sound the remote receiver. **The remote receiver will sound for an additional 3 seconds after the pool unit has been silenced. If the REMOTE RECEIVER beeps once approximately every 20 seconds, it is indicating that the 9v battery in the pool unit is low and needs to be replaced.** After you have purchased your POOLGUARD alarm and you wish to add another remote receiver to your alarm system you can acquire one from PBM Industries, Inc. Contact PBM by phone or mail or contact your place of purchase.

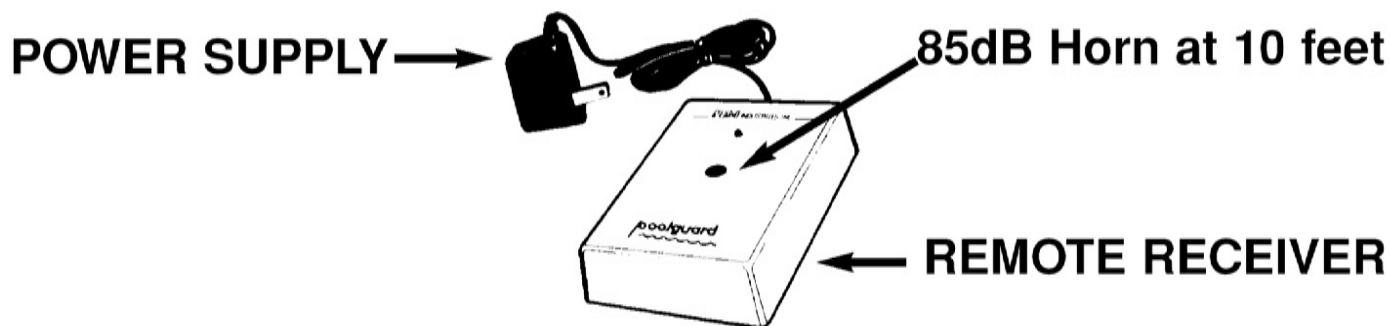

FIGURE 5

TO OPERATE YOUR REMOTE RECEIVER

Try to locate your **REMOTE RECEIVER** in a convenient part of your house close to the pool. Avoid steel walls or any other large metal objects or obstructions that might interfere with the signal reception. The **REMOTE RECEIVER** has to be placed on the same level or a level above the pool in the house (do not place receiver in an underground basement). The ideal location for your **REMOTE RECEIVER** would be by a window overlooking your pool. Test your **REMOTE RECEIVER** in different locations in your house to find the best working place for your receiver. Plug in your power supply to any standard wall outlet and insert the jack into the receiver. Check that the indicator light is on. Your **REMOTE RECEIVER** unit is now ready to receive a transmission from your **POOLGUARD** unit. **DO NOT USE YOUR REMOTE RECEIVER OUTDOORS.**

SWIMMING POOL SAFETY TIPS

- Supervise children at all times.
- Never permit swimming alone. Never leave a child alone, even to answer the telephone.
- Always remove the entire solar cover from a pool before swimming.
- Remember that alcohol and water safety do not mix.
- Have your pool area fenced and the gate locked to prevent unauthorized entry to the pool, and install a gate alarm.
- Lock and secure all doors in the house which permit easy access to the pool, and install a door alarm.
- Have a responsible adult teach swimming and water safety to your children.
- Maintain clean, clear water in the pool.
- Do not swim during electrical storms.
- Do not permit bottles, glass, or sharp objects to be used around the pool.
- Ask your pool dealer how you can improve your pool safety—they will be glad to assist you.
- Above all: remember that common sense, awareness, and caution will allow you to enjoy your pool.

WARRANTY AND REPAIRS

POOLGUARD is sold with a limited warranty to cover defects in parts and workmanship for three years from date of purchase (retain proof of purchase).

If POOLGUARD exhibits a defect, please call Customer Service at 1-800-242-7163. Unauthorized returns will not be accepted. Proper repair is only ensured when the unit is returned to the manufacturer.

SEND CORRESPONDENCE TO:

PBM INDUSTRIES, INC.
 P.O. BOX 658, NORTH VERNON, IN 47265
 1-800-242-7163

This product has been designed to aid in the detection of unwanted intrusions into unsupervised pools. POOLGUARD IS A SAFETY ALARM SYSTEM AND NOT A LIFE SAVING DEVICE. "This device is not intended to replace any other safety consideration - i.e., adult supervision, lifeguards, fences, gates, pool covers, locks, etc., and some devices may not detect gradual entry."



HELPFUL HINTS AND TROUBLESHOOTING

POOLSIDE UNIT

IN-POOL
ON POSITION

poolguard®

Power Supply



Remote Receiver

POOLSIDE UNIT

OUT OF POOL
OFF POSITION

FALSE ALARMS

All pool alarms will false alarm on occasion for different reasons. False alarms can be minimized; however, it is important to remember that a false alarm is better than no alarm at all.

WEATHER & WIND—POOLGUARD sets stationary on the top rail of the pool so the wind will not effect the alarm unit itself. Wind may trigger a false alarm if it is strong enough or steady enough that it causes the water in the pool to rock or bounce up and down the pool wall. On extremely windy days when the pool water is rocking it is advised to remove the alarm from the pool. **LIGHT WIND OR RAIN WILL NOT EFFECT THE POOLGUARD ALARM.**

Another false alarm occurs when the pool owner tries to install the alarm too soon after swimming. After swimming, the water in the pool will rock or bounce up and down the pool wall for some time depending on the size of the pool and the type of swimming activity. Before installing the alarm, after swimming, the pool must be given time to calm. Time will vary (around 10 to 30 minutes); once the pool owner sees that the pool water is no longer rocking up and down the pool wall, it is time to install the alarm.

FALSE ALARMS (Continued)

Certain automatic cleaners may set the POOLGUARD unit off in some cases. If the cleaner head or the cleaner hose hits the POOLGUARD alarm it may cause it to false alarm. Solutions to this problem are to use your cleaner at night and your alarm during the day. Another option would be to find a place around the pool where the cleaner does not interfere with the alarm.

ALARM WILL NOT SOUND

Be sure that a 9 volt battery has been installed properly. If you are testing and it does not alarm, be sure you are testing properly putting your feet in the pool, splashing with your hands, making waves with a leaf skimmer, or dropping something into the pool that does not have the proper size, weight and volume **WILL NOT SET POOLGUARD ALARM OFF!** Testing is very important and should be done correctly. **BE SURE YOUR RETURN LINE EYEBALL FITTING IS POINTING DOWN.**

CARE AND HANDLING

POOLGUARD is made of sturdy PVC Plastic. Because the alarm is electronic and mechanical, great care should be taken not to drop the unit; like any other appliance, it may break. Sun and rain will not hurt the alarm. **POOLGUARD** is water resistant but not waterproof. Great care should be taken not to drop the alarm into the pool. If the alarm goes into the pool, there are directions in the manual on how to dry it out but more than likely, it will have to be returned to the factory for service. **ALWAYS REMEMBER TO REMOVE THE ALARM BEFORE USING THE POOL.**

REMOTE RECEIVER

The only thing that can put the remote receiver into the alarm mode is the poolside unit. It sends a coded RF (Radio Frequency) message from the poolside unit to the in-house remote receiver. When the unit at the pool alarms, the remote receiver will sound. **Maximum Range for the remote is 200 feet** from the poolside unit. Avoid placing remote in basements or around metal walls. Be sure that the red light on the remote is on. Remember the poolside unit must be beeping (alarming) for the remote to work.

If your remote receiver is not getting a clear signal or no signal from the poolside unit, try the following: Before plugging in the remote power supply, be sure to **stretch out the cord**; do not leave it tied in a bow as packaged. When you first plug in the remote it will give one short loud beep then stop—this is just a power surge.

Your Remote Receiver is similar to a small portable radio. If your remote is not sounding when the poolside unit is sounding—move the remote to different locations, and stand back for a few seconds for the remote to pick up the signal. You may only have to move your remote a little to the left or right to bring in the signal—in some cases you might have to move the remote to a different location or another room. If you cannot get a signal on your remote—Call Customer Service at 1-(800) 242-7163.

QUICK DO'S AND DON'TS

- **Do read the manual carefully**
 - **Do install a 9 volt battery**
 - **Do untie the bow on the power supply**
 - **Do test the alarm properly**
 - **Do turn your return line eyeball fitting towards the bottom of the pool**
 - **Do remove alarm before swimming**
 - **Do hold on to your red customer service card with our 800 service number**
 - **Do be extremely careful when using an electric drill around your pool**
-
- **DON'T leave alarm in pool while swimming**
 - **DON'T drop your alarm, it may break**
 - **DON'T let your alarm fall into the pool**
 - **DON'T install your alarm immediately after swimming**
 - **DON'T turn your return eyeball fitting towards the top of the pool**
 - **DON'T use your alarm on extremely windy days**
 - **DON'T be careless with an electric drill around your ABOVE GROUND POOL. Extreme caution should always be used when using electricity around water!**



poolguard®



POOLGUARD POOL ALARMS
“BEST SOLUTION”
GOOD HOUSEKEEPING
MAGAZINE

*The name you can trust,
since 1982.*

One source for all
your pool safety alarms,
number one in
customer service.
All products
made in the USA.



**IN GROUND
POOL ALARM
WITH REMOTE**



**ABOVE GROUND
POOL ALARM
WITH REMOTE**



**Poolguard's
Family of Products
Helps Protect Your Family!**



GATE ALARM

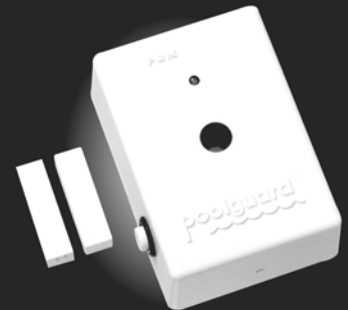

DOOR ALARM

www.poolguard.com

Call Toll Free 1-800-242-7163

P.O. Box 658 • North Vernon, Indiana 47265