



FeherGuard

ASSEMBLY INSTRUCTIONS

AUTO REEL

Automatic Rollup
FAR18 & FAR20

PLEASE READ ENTIRE INSTRUCTIONS CAREFULLY BEFORE PROCEEDING

Four Easy Steps:

If you need additional assistance, contact us at info@feherguard.com or call 905-876-4766 Monday to Friday 8:30 a.m. to 5:00 p.m. Eastern Time.

Before starting assembly, trim cover to clear the inside top edge of your pool.

Recommended Solar Cover is 12 mil with round bubbles.

Allow an extra 4" (10 cm) on cover length if installing the reel at mid-point or off-center.

REEL SYSTEMS COMPONENTS AND PREPARATION:

Getting started:

Ensure that your system has two cartons consisting of one end carton and one tube set carton.

Tools required for assembly: Recommend Safety Glasses

Portable drill (driver bit provided)

Tape measure

Pencil and Scissors

Tube Carton Parts List:

2 end tubes and 1 center tube

AUTO REEL Parts List:

1 Bracket End 1 Bearing
1 Auto End 1 Handle
2 Plugs for 2 1/2" diameter tubes
1 Water Discharge Hose
1" Quick-Connect for Garden Hose
(Garden Hose not provided)

Hardware Kit: 20 Strap Plates
10 Straps 10 Plastic Screws
27 Self-drilling Metal Screws
1 Driver Bit

STEP 1: SOLAR REEL PLACEMENT:

Optional Locking Casters Available

A. Determine the best location for the reel system. The widest point of the pool is the preferred locations (see Fig. 1 below).

B. At the determined location, measure the width of the pool and add 6" (15 cm).

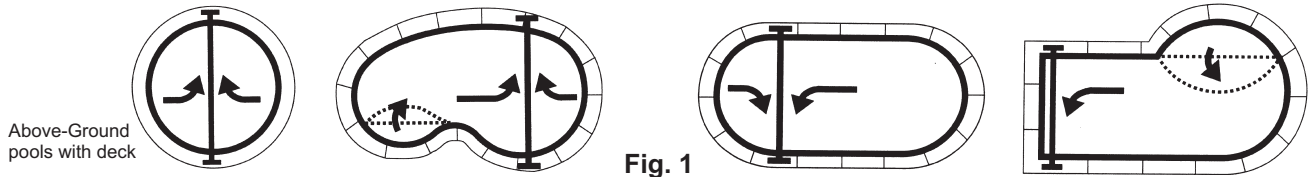

Above-Ground pools with deck

Fig. 1

STEP 2: TUBE ASSEMBLY

A. Ensure minimum of each end tube is inside center tube (see table below right). Less than minimum insert causes screws to loosen and/or tubes to split.



Fig. 2

Insert both end tubes equal distance into center tube and mark on center tube where inner tubes end

Tube	Min. Insert	Max. Width	Max. Wet Cover Weight	Max. Cover
20' (6.1m)	12"	20'6" (6.3 m)	60# (27.3kg)	20x40
18' (5.5m)	9"	18'6" (5.7 m)	60# (27.3kg)	18x36

Mill tubes tarnish over time. This does not affect tube integrity.

THIS STEP REQUIRES A TOTAL OF 12 SELF-DRILLING SCREWS DO NOT pre-drill holes or over-tighten screws.

B. Lock tubes together by rotating the center tube in the opposite direction to end tube. HOLD TUBES LOCKED WHILE YOU INSTALL FIRST SELF-DRILLING SCREW ON A DRILL LINE, 1" (2.5 cm) back from end of center tube at Location "C1" (see Fig. 3 & 4).

C. Place 2 more self-drilling screws at Location "C2" & "C3" - 1 screw at every second drill line around tubes (see Fig. 3).

D. At "D" locations install 3 screws around the center tube at every second drill line, 1" (2.5 cm) back from where you marked the end of the inner tube from Fig. 2A (see also Fig. 3).

E. Repeat for other end tube.

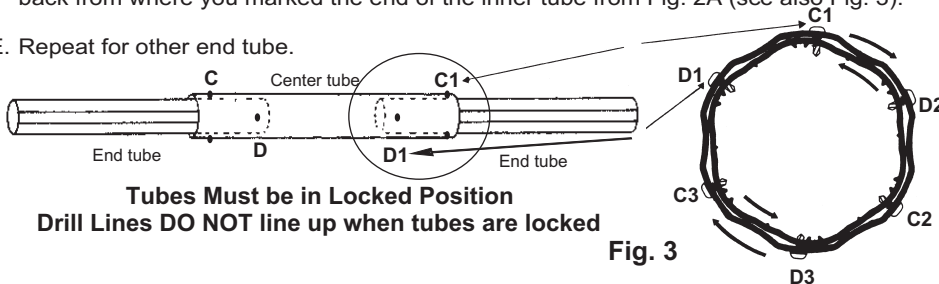

Fig. 3

Tubes Must be in Locked Position
Drill Lines DO NOT line up when tubes are locked



Fig. 4

STEP 3A: ASSEMBLE BRACKET END

Assemble in numerical order (see Fig. 5):

- Insert Plug (#1) into End Tube.
- Place Bearing (#2) inside End Bracket
- Push Handle (#4) through Bearing and fully into Tube with Plug.
- Insert 1 self-drilling screw (#5) through tube in line with bump on plug rim and 1" (2.5 cm) from tube end. (see Fig. 7).

STEP 3B: ASSEMBLE AUTO END

- Insert Plug (#1) into End Tube.
- Push Tube with Plug fully onto Auto End shaft.
- Insert 3 self-drilling screws (#5) through tube in line with a bump on plug rim (at Long Prongs) and 1" (2.5 cm) from tube end. (Fig. 7)
- Push Water Discharge Hose onto right side of Auto End (Fig. 6)

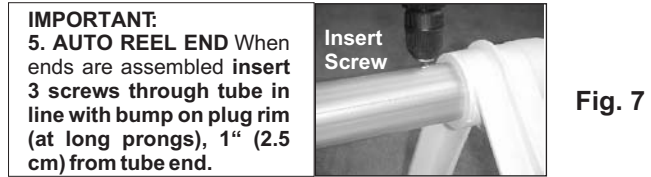
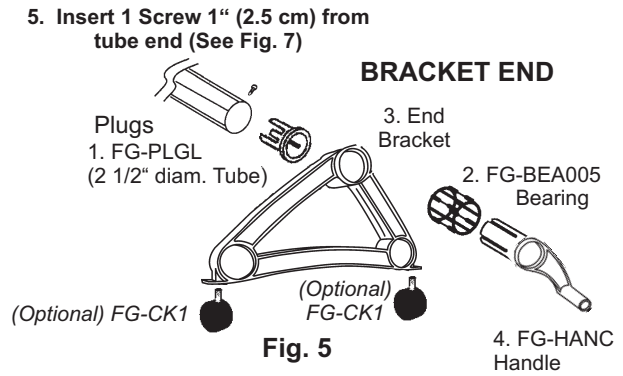

STEP 4: STRAP ATTACHMENT

Attach a Strap Plate to EACH end of all Straps provided (see Fig. 8).

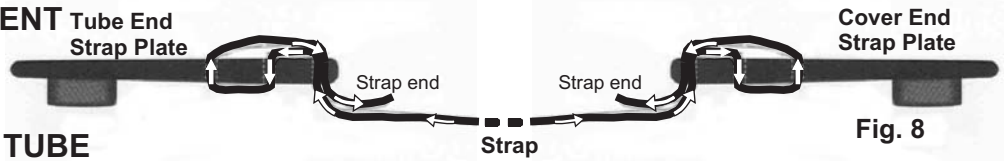

STRAP ATTACHMENT - TO TUBE

- Mark strap plate location on tube drill lines. First strap plate is placed 6" (15 cm) in from inside edge of pool or at the start of the radius corner (see Fig. 9).
- Attach strap plates to the tube with metal screws (see Fig. 10). **DO NOT pre-drill holes or over-tighten screw.** Use all straps provided.

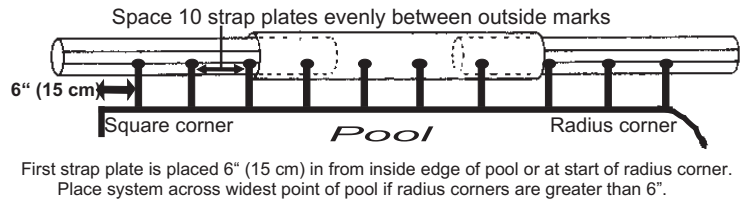
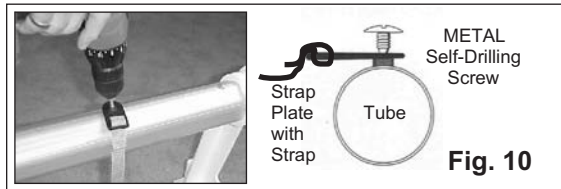

STRAP ATTACHMENT - TO COVER

- Choose either Fig. 11 OR Fig. 12 - the appropriate instructions below for your pool shape. If you have determined a mid-pool or off-center placement, it will be easier if you move the cover away from the pool and fold it (bubbles in) on a flat surface.

For Systems Placed at Pool End (Rectangular Pools) (Fig.11)

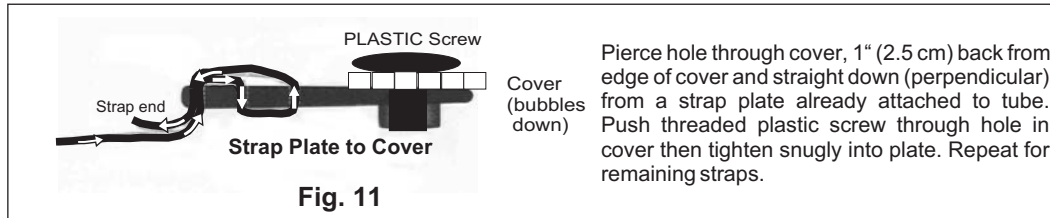

For Systems placed at Mid-Pool or Off Center (Round or Irregularly Shaped Pools) (Fig. 12)

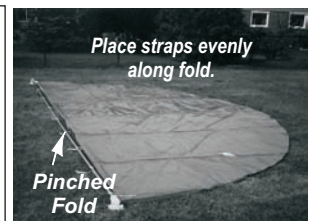
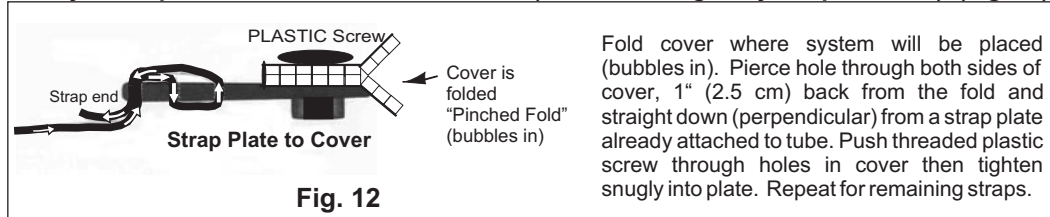

- When you start to roll up the cover, all straps must take hold of the cover at the same time. Adjust the strap lengths if necessary.

USING YOUR AUTO REEL

PLACING COVER ON POOL:

1. Move Reel System (with cover attached) across the pool to the exact location where you determined in Step 1. (Optional Locking Casters are available - see Accessories below.)
2. **Auto End Lever must be in the "REST" (Neutral) position.**
3. Using the handle at the Bracket End, **unroll the cover 5 turns** (releases any pressure in Auto End) then "walk" cover slowly onto the pool.

REMOVING COVER FROM POOL:

1. Using Quick-Connect (provided), attach your garden hose onto left side of Auto End (Fig. 13).
2. Turn on the water then move the Auto End Lever to the left - "REWIND". The cover will roll up automatically. Adjust cover if necessary.
3. **When the cover is completely rolled, return Lever to "REST" (Neutral).**
4. Turn off water.
5. Disconnect Garden Hose from Auto End.

Safe use of your Solar Reel:

COMPLETELY REMOVE REEL SYSTEM / COVER FROM THE POOL BEFORE SWIMMING.

Under no circumstances, should one swim in a pool partially covered by the solar cover.

Solar Reel systems are designed solely to remove solar covers and are not made to support people or any other weight.

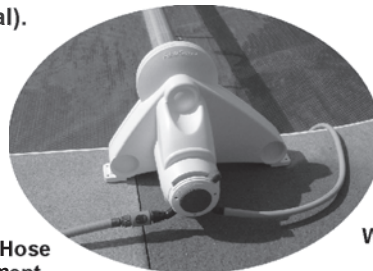

AUTO END

Fig. 13

Care and Storage:

1. **DO NOT ALLOW AUTO END TO FREEZE ! Warranty will be void.**
IF THERE IS A DANGER OF FREEZING TEMPERATURES, REMOVE AUTO END FROM SYSTEM, TURN TUBE SHAFT UNTIL ALL WATER HAS DRAINED AND STORE IN A LOCATION ABOVE FREEZING.
2. Check screws periodically and tighten, if necessary.

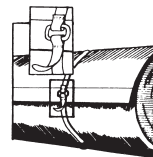

(FG-BS2)

ACCESSORIES AND OTHER PRODUCTS AVAILABLE FROM YOUR DEALER:



- FG-FASKIT TUBE & BLANKET FASTENING KIT (10 sets straps & fasteners per pouch)
- FG-PFS TUBE AND BLANKET FASTENERS (10 sets fasteners per pouch)
- FG-RS26 REEL STRAPPING (10 Straps 26" per pouch)
- FG-RS50 REEL STRAPPING (1 - 50' Roll)
- FG-BS2 BLANKET STRAPS (2 x 54" per pouch)
- FG-WPS WHITE PROTECTIVE SHEET (24' x 3 1/2' sheet with UV inhibitors)
- FG-MPR MID-GRIP PULL ROPE
- FG-CK1 LOCKING CASTERS (SET OF 4)

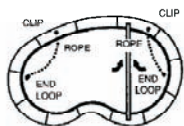

Clips to side for easier access when cover is rolled.

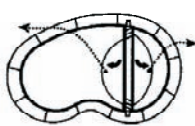

Makes pulling cover onto the pool easier.

MID-GRIP PULL ROPE ACCESSORY (FG-MPR) (Available from your Dealer)

For ease of pulling cover on pool, we suggest using the Mid-Grip Pull Rope accessory. This easily attaches to the cover as shown at the left.



VACUUM HOSE REEL Available through your local dealer

FG-VHG

- Holds up to 50' of 1 1/2" Vacuum Hose
- Durable polyethylene construction
- Also for Pool Backwash Hose, Electrical Cord (100') or Garden Hose (100')



FG-VHG



One Year Warranty:

FeherGuard warrants for a period of one year from the date of delivery to the original consumer purchaser, that the AUTO REEL System shall be free from defects in workmanship or material, under normal use and in accordance with FeherGuard's written installation and use instructions. FeherGuard at its option shall supply free of charge any part found to be defective in workmanship or material.

Any implied warranties are limited in duration to the one-year period from the date of delivery to the original consumer purchaser.

This Warranty is void if there is evidence of purchaser abuse, improper installation or normal wear.

FeherGuard will not be liable for incidental or consequential damages resulting from any defects in workmanship or material. Some States/Provinces/Countries do not allow the exclusion or limitation of incidental or consequential damages, so the foregoing limitations or exclusions may not apply.

This Warranty gives the claimant specific legal rights. The provisions of this Warranty are in addition to and not a modification of or a subtraction from the statutory warranties and other rights and remedies contained in applicable local legislation.

To validate Warranty, return this registration form within 30 days of purchase. You may also register your warranty online on our Home Page at www.feherguard.com.

Warranty claims should be processed through your Dealer and include your proof of purchase.

FeherGuard Products Ltd.
821 Main Street East
Milton, Ontario CANADA
L9T 3Z3

Specifications subject to change without notice.

3/08

**Thank you for buying the AUTO REEL System.
We know it will make solar cover handling easy for you.**



FeherGuard "One Year" Warranty Registration

Please Print

PURCHASER: _____

ADDRESS: _____ CITY: _____

STATE/PROVINCE/COUNTRY: _____ ZIP/POSTAL CODE: _____

AUTO REEL

MODEL #

STORE LOCATION

PURCHASE DATE